

A Novel, Semi-Pilot Scale Electrolysis System for the Production of p-Aminophenol

Kamran POLAT

*Ankara University, Faculty of Science, Department of Chemistry,
06100 Tandoğan, Ankara-TURKEY
e-mail: kpolat@science.ankara.edu.tr*

Received 13.03.2001

Cyclic voltammetry (CV) and preparative electrolysis techniques were used to investigate the reduction of nitrobenzene into (NB) p-aminophenol (p-Ap). The electrodes used in CV experiments were glassy carbon (GC), TiO₂/Ti, Sn and Pb. The preparative electrolyses were carried out by the use of Pb, Sn, carbon cloth and TiO₂/Ti electrodes.

The CV data were evaluated according to Nicholson-Shain criteria, and it was deduced that the reductions on TiO₂/Ti and GC electrodes were irreversible and monitored by an electrochemical-chemical-electrochemical mechanism. No reduction peak was observed with Sn and Pb electrodes.

Preparative electrolyses were carried out under current-controlled conditions in the presence and absence of solvent. The best yield of (p-Ap) was obtained with a circulating neat NB electrolysis system on a TiO₂/Ti electrode.

Key Words: Nitrobenzene, p-aminophenol, cyclic voltammetry, continuous electrolysis, electrolytic reduction.

Introduction

p-Aminophenol (p-Ap) is used as a dye intermediate and photographic developer. It is manufactured through several chemical methods¹. An alternative method is the electrolytic method, and this route appears to be preferable because it is clean and poses no pollution problems. The yield is also higher than that achievable chemical methods, and the purity of the product is better.

The electrolytic reduction of nitrobenzene (NB) to p-Ap was first described by Gattermann using a Pt cathode, at an ambient temperature in a highly acidic reaction medium^{2,3} where NB (I) was converted into p-Ap (III) by the rearrangement of the phenylhydroxylamine (II) intermediate as follows:

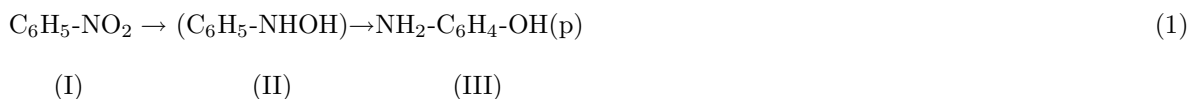

Gattermann's method was modified by Darmstadler^{4,5} and Thatcher⁶, and was utilised by the Eastman Kodak Co⁷. for the large-scale production of p-Ap. Although this method was much more popular than

the chemical method, it was not as commercially promising as the method developed by Dey et al⁸ These workers developed a new method using low concentration sulphuric acid and cheaper cathode materials such as Cu, monel, Ni and Pb. Wilson and Udupa⁹ obtained high current densities by rotating the electrodes at very high speeds. Fleishmann et al¹⁰ proposed the following overall reaction scheme for Dey's method of reduction:

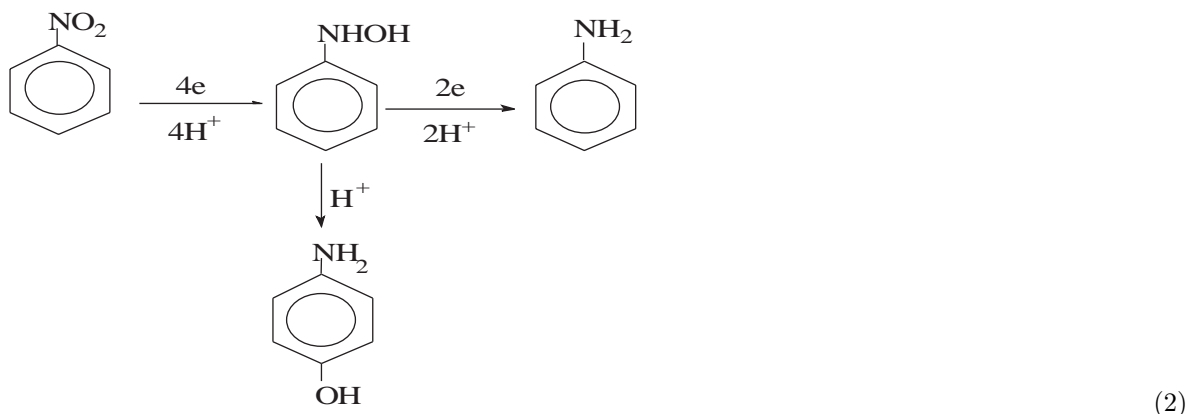

The studies performed were mainly concerned with the effect of temperature, H₂SO₄ concentration, cathode material, type of diaphragm, the solvent and the mediating reducing agent employed, on the reduction of NB to p-Ap¹¹⁻¹⁹.

The solvent used and, the concentration of the background electrolyte, the acid, were reported to be the critical parameters which could be varied^{11,14,19}. Several studies^{9,11,14-20} have shown that, the electrolytic reduction involves a step of rearrangement of phenylhydroxylamine (PHA) to p-Ap and that this step requires temperatures above 70 °C. At high temperatures many solvents tend to evaporate. Therefore, any modification to the process which eliminated the use of a solvent would be desirable.

In this study TiO₂/Ti, carbon-cloth, Sn and Pb electrodes were compared in terms of product yield and selectivity (competitive formation of aniline (AN)). The reduction of NB to p-Ap without solvent and also in a 50:50 2-propanol/water medium, was achieved. The electrolysis process was carried out while the catholyte was being circulated through the cathode surface. The solvent medium, on the other hand, was kept stationary to avoid the corrosive effect of the acidic aqueous mixture.

Experimental

The electrodes employed in the cyclic voltammetry (CV) studies were as follows: Pb (Aldrich, 99.99% with a diameter of 1 mm), glassy carbon (GC) (Aldrich, 99.99%, with a diameter of 5 mm) and Sn (Aldrich, 99.9%, 0.33.0 mM × 2.8 mm) mounted into Teflon rods filled with acrylic polymer. Ti electrode (Aldrich, 99.7%, 3.0 mM × 3.5 mm) were oxidised to TiO₂/Ti according to the literature²⁰ and embedded into Teflon rods similar to the other electrodes. The supporting electrolyte used in the CV was 2 M H₂SO₄ in a solution of 50% 2-propanol/50% water (*v/v*).

CV experiments were carried out using an EG& G Princeton applied research potentiostat and a Karl Kobb Scientific Technical Supplies-made Servagor X-Y recorder. The counter and reference electrodes were helical Pt wire and saturated calomel, respectively.

All the electrodes except TiO₂/Ti were first subjected to mechanical treatment with first rough and then fine emery paper, kept in dichloromethane in order to remove any grease from the electrode surface, shaken in bi-distilled water for a few minutes and wiped with drying paper before being placed into the electrolytic cell. The cell was purged with N₂ purified with vanadium (II) chloride, concentrated HCl and amalgamated Zn for 30 min prior to each experiment and blanketed thereafter. It was observed that the reduction peak currents decreased with the number of scans when the electrodes had not been subjected to this pre-treatment. The curves obtained with the pre-treated electrodes, on the other hand, were highly reproducible. The potential and the scan rate, ranged between 0.0 and -1300 mV and between 1 and 500 mV s⁻¹, respectively.

All the solvents and the acids used in the study were analytical grade (Merck) and were used without further purification. Bi-distilled water with a conductivity of $1/1.34 \times 10^{-6} \Omega$ was used throughout the experiments.

The cathode materials (Pb, Sn and TiO₂/Ti plates with dimensions of 13 cm × 10 cm rolled in a cylindrical form) were used in the preparative electrolyses. The carbon cloth electrode (13 cm × 10 cm) was also formed in a cylindrical form mounted on a glass support. The anode department was a ceramic cup with dimensions of 16 cm × 2.8 cm × 0.4 cm. The capacities of the anode and cathode compartments were 200 and 120 cm³, respectively. The supporting electrolytes used in the stationary-solution and circulating-catholyte preparative electrolysis studies were 2 M H₂SO₄ in a solution of 50% 2-propanol/50% water (*v/v*) and a 2.0 M solution of H₂SO₄, respectively.

In the circulating-catholyte preparative, electrolyses were carried out by circulating NB over the surface of the cathode without using any solvent. The device used in in the circulating-catholyte preparative electrolyses is shown in Figure 1. The catholyte was transferred to the cell by the use of a peristaltic pump (Prominent Electronics) with a capacity of 8.9 L per hour. The solution was purged with purified N for 2 h with constant stirring. The temperature of the electrolyte was kept at 80 ± 2 °C using a thermostat. The

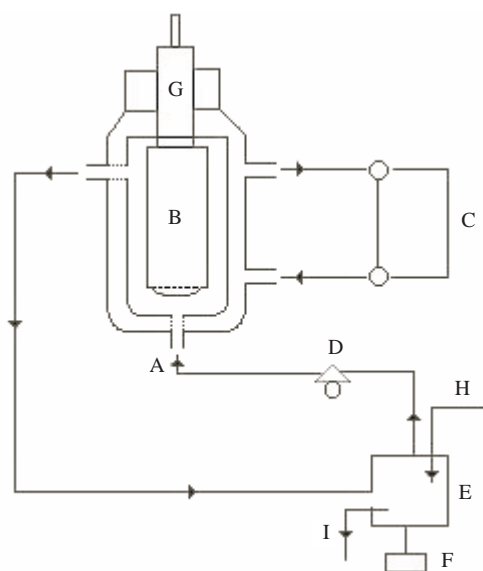

Figure 1. The experimental set-up for circulating neat catholyte preparative electrolyses. A: Electrolytic cell, B: Cathode, C: Thermostat, D: Peristaltic pump, E: Electrolyte reservoir, F: Magnetic stirrer with a heater, G: Anode compartment, H: N₂ inlet, I: N₂ outlet.

same electrochemical cell was also employed in the stationary-solution electrolyses of NB. The electrolyses were carried out using a 250 V/25 A power source, and the charge passing through the circuit was monitored with an electronic integrator (System Technic, Model 274).

Results and Discussion

Cyclic voltammetric investigation

The CV curves obtained with GC are given in Figure 2, which shows a single irreversible peak.

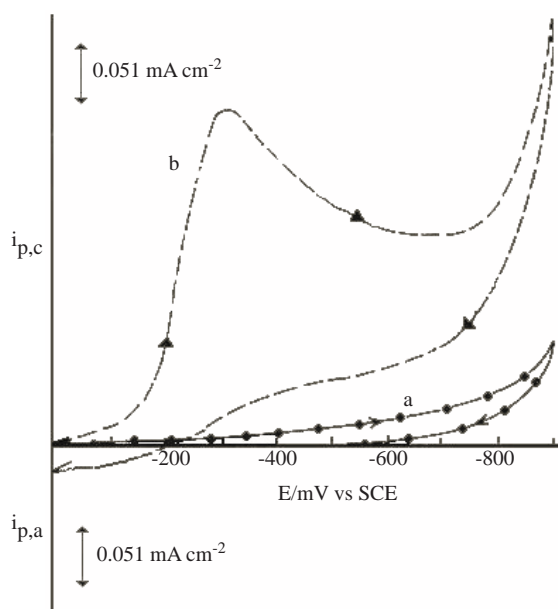

Figure 2. Cyclic voltammograms on GC electrode at a scan rate of 50 mV s^{-1} , **a:** $2.0 \text{ M H}_2\text{SO}_4$ (50:50 water/2-propanol), **b:** 3.0 mM NB in $2.0 \text{ M H}_2\text{SO}_4$ (50:50 water/2-propanol).

The CV data obtained with a GC electrode were evaluated according to Nicholson-Shain criteria²¹ by plotting the current density and the current function against the scan rate (Figures 3 and 4). The graph of I_p vs. $v^{1/2}$ gave a straight line (Figure 3) while the graph of current function against the scan rate resulted in a concave curve decreasing towards the higher scan rate (Figure 4).

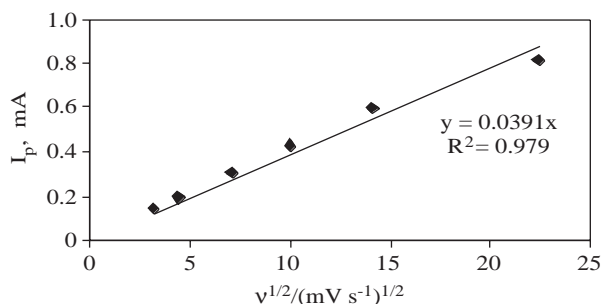

Figure 3. The change of peak current with the scan rate on glassy carbon electrode.

With the GC electrode, the effect of the concentration of NB on the appearance of the curve was also investigated. Figure 5 shows the peak current density against the concentration of the electroactive compound, indicating that the current density increases linearly with the concentration.

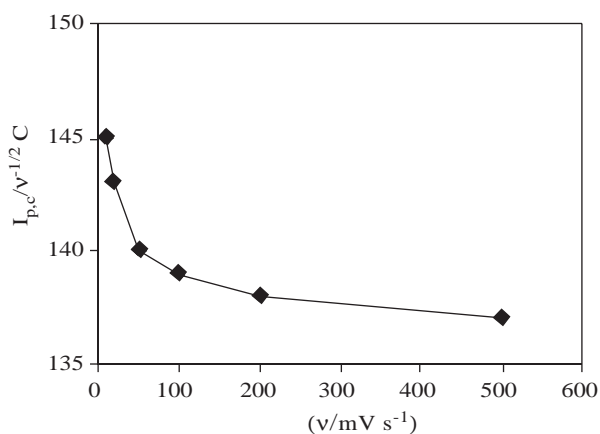

Figure 4. The change of current function with the scan rate on glassy carbon electrode.

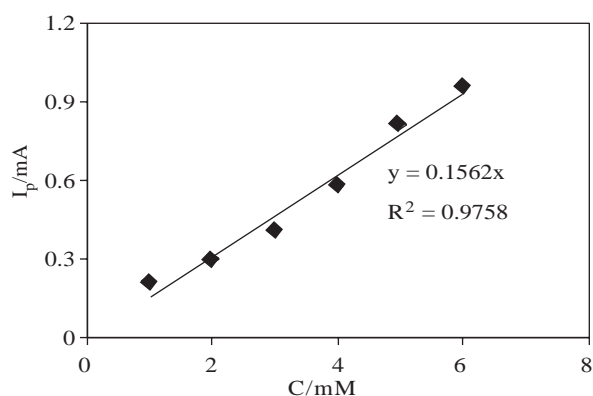

Figure 5. The change of peak current with the concentration of the NB on GC electrode.

The fact that the current density increases linearly with the scan rate and the dependence of the shape of the curve on the NB concentration shows that the reduction process is diffusion-controlled on the GC electrode. The current function does not have a definite correlation with the scan rate, and the electron transfer must have been preceded by a chemical reaction since these two parameters correlate linearly in the absence of chemical complications²¹. The parameter $dE_p/2/d\log\nu$ was found to be 35-45 mV which complies well with the criterion of $dE_p/2 / d\log\nu = 30/\alpha n_a$ (mV) for electrochemical-chemical-electrochemical reactions²¹.

The fact that there was no anodic peak after reversal from the H₂ evolution potential shows that the total reduction process and the chemical reaction are irreversible and that the product of the chemical reaction is electrochemically inactive. In previous reports on the same reaction it was also pointed out that the total reduction and the chemical reaction were totally irreversible and the rate of the chemical reaction was 100 times higher than that of the electrochemical reaction¹⁸.

The reduction of PHA to AN by taking a pair of electrons from the cathode surface competes with the rearrangement to form p-Ap^{111,18,19,22}. Therefore, the higher the rate of the chemical reaction the higher the yield of p-Ap¹⁸.

It is reported in the literature that the reduction of PHA into AN takes place concomitantly with the H₂ evolution reaction. Therefore, the yield of p-Ap is expected to be higher on metals which exhibit a higher H₂ overvoltage²³.

TiO₂/Ti electrode

Figure 6 shows the voltammograms obtained in 2.0 M H₂SO₄ in 50% 2-propanol/50% water. Curves A and B are obtained before and after the addition of the electroactive compound, respectively.

Figure 6 A shows the typical cyclic voltammograms representing the redox behaviour of the species present on the electrode. The voltammogram, A, displays two subsequent broad cathodic waves, I and II,

within -900 mV beyond which H_2 evolution occurred. In the reverse scan, two anodic waves, III and IV, appeared.

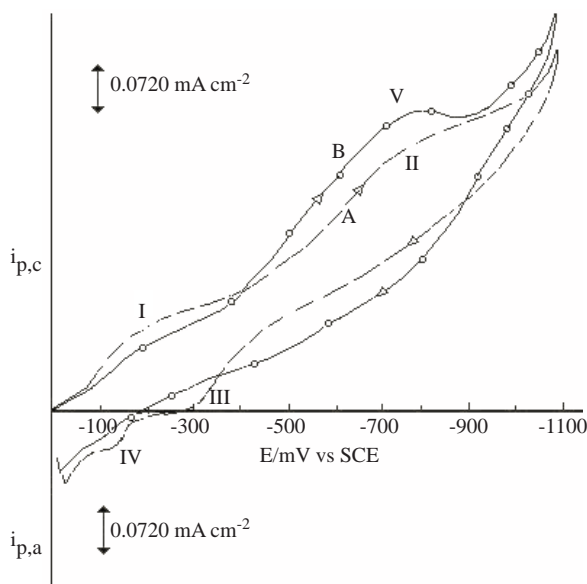

Figure 6. The cyclic voltammograms on Ti/TiO₂ electrode at a scan rate of 50 mV s^{-1} A: in $2.0 \text{ M H}_2\text{SO}_4$ (50:50 water/2-propanol) B: 5.0 mM NB in $2.0 \text{ M H}_2\text{SO}_4$ (50:50 water/2-propanol).

In the studies carried out with a TiO₂/Ti electrode on similar compounds it was suggested that the first cathodic wave, I, is due to the reduction of Ti(OH)₄ as follows^{24–27}:



The second cathodic wave, II, which occurs at a slightly more negative potential, is due to the following reaction



The anodic waves, III and IV, are due to the corresponding reverse reaction (oxidation of Ti⁺³ to Ti⁺⁴).

Figure 6 B shows the typical cyclic voltammogram obtained on TiO₂/Ti with 5.0 mM NB and $2.0 \text{ M H}_2\text{SO}_4$ in the solvent system (50% 2-propanol/50% water) at 50 mV s^{-1} . In the presence of NB the anodic waves completely disappeared and the cathodic wave V, was observed in a peak shape.

The increase in the current value of wave II (Figure 6 B) may either be due to the combined current for the reduction of Ti⁺⁴ species and direct reduction of NB or to the reduction of the large amount of Ti⁺⁴ species generated instantaneously by the fast chemical reaction:

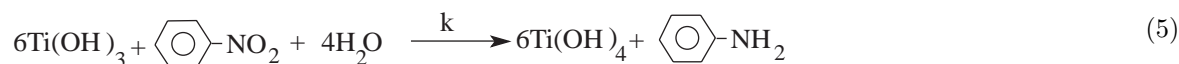

No anodic wave was observed in the presence of NB, indicating the absence of Ti⁺³ species for oxidation on reverse scans. The only possibility in the absence of Ti⁺³ species in the presence of NB is the

heterogeneous chemical reaction suggested in Equation 5, and the fast regeneration of Ti^{+4} species, which is responsible for the large increase in current for the reduction of NB.

It is concluded that the TiO_2/Ti electrode behaves as a very good heterogeneous redox catalytic electrode and that NB undergoes a fast chemical reduction on it.

Sn and Pb electrodes

The potential range in the case of the Sn electrode was 0.0 to -1200 mV. It was observed that the current does not change potentials more positive than -400 mV. There are peaks between -500 and -700 mV in the cathodic region due to the reduction of the Sn ions dissolved in the acidic media and there are peaks in the anodic region corresponding to their re-oxidation (Figure 7). As seen from the figure, the faster the scan rate the higher the peak current densities of cathodic and anodic voltammograms, and the cathodic peak potentials shift to more negative values and the anodic peak potentials to more positive values. The addition of NB into the reaction medium resulted in the peaks in the anodic and the cathodic regions diminishing and it became very difficult to distinguish the peaks corresponding to the reduction of the NB (Figure 8).

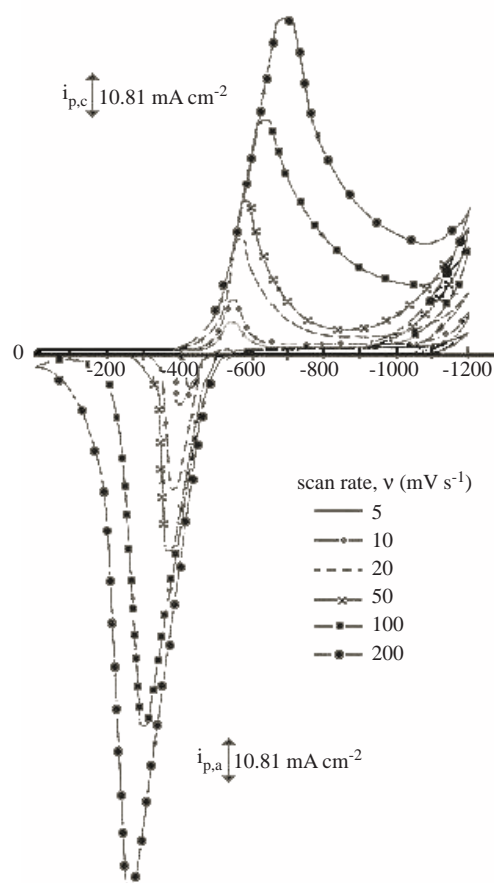

Figure 7. Cyclic voltammograms of 2.0 M H_2SO_4 (50:50 water/2-propanol) on Sn electrode at different scan rates.

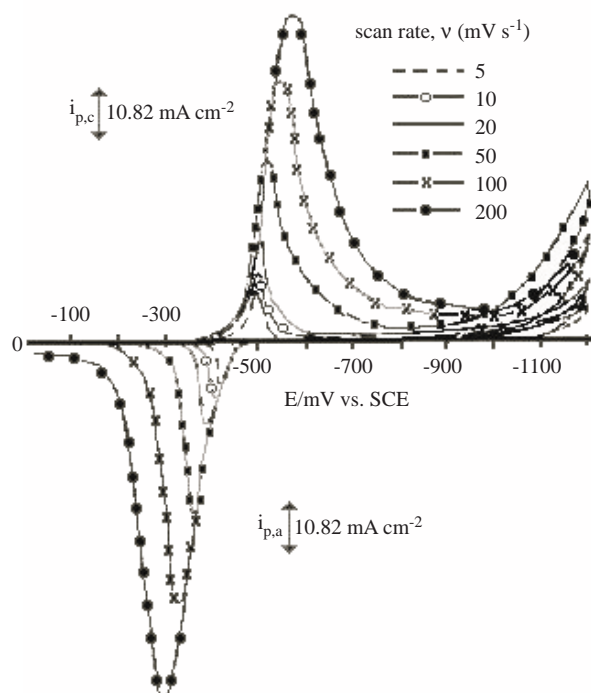

Figure 8. Cyclic voltammograms of NB (3.0 mM) in 2.0 M H₂SO₄ (50:50 water/2-propanol) on Sn electrode at different scan rates.

The decrease in the current density of the cathodic and anodic peaks obtained with the Sn electrode on the addition of the NB can be attributed to the interaction of Sn²⁺ ions with the NB in the medium causing a subsequent decrease in the fraction of the ions coming to the electrode surface.

The biggest problem with the Pb electrode was the determination of a suitable potential range: this was chosen as -300 and -1300 mV due to the oxidation of Pb as PbSO₄ and the subsequent passivation of the surface. As with the Sn electrode, the voltammograms were first recorded without the addition of NB (Figure 9 a) and then with the addition of 3.0 mM (Figure 9 b) and 10.0 mM (Figure 9 c) NB with a scan rate of 50 mV s⁻¹.

Figure 9 shows that the current remains constant up to -570 mV in the cathodic region and shows a peak between -600 and -770 mV. The H₂ evolution process takes place at almost the same potential (between -1000 and -1100 mV) in the curves obtained for the supporting electrolyte and for those obtained after the addition of NB. With the addition of NB to the electrolyte the characteristics of the CV curves underwent several marked changes. The cathodic and anodic peak current densities decreased considerably and their potentials changed. During the cathodic and anodic sweep, there was a correlation between the concentration of the NB and the current density. As NB concentration increased (Figure 9 c), the reduction and oxidation peak current densities decreased. The decrease of the cathodic and anodic current density is attributed to adsorption of the NB molecules on the electrode surface.

Previous reports^{28,29} assert that the peaks, which occur in the cathodic region are due to the reduction of PbSO₄ to Pb and that those in the anodic region correspond to the oxidation of PbSO₄ to PbO₂.

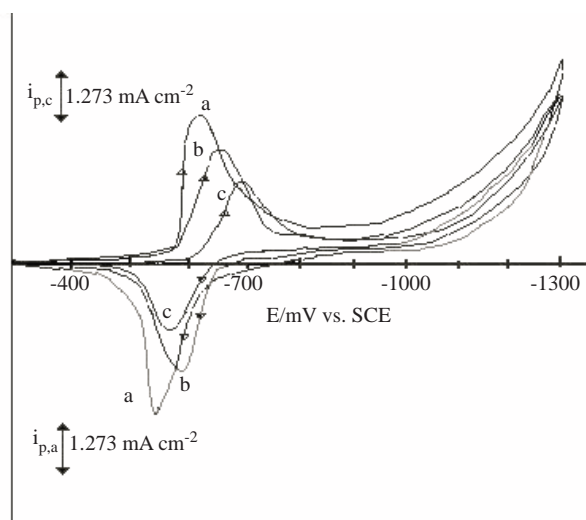

Figure 9. Cyclic voltammograms on Pb electrode at a scan rate of 50 mV s^{-1} ; a: $2.0 \text{ M H}_2\text{SO}_4$ (50:50 water/2-propanol). b: 3.0 mM NB in $2.0 \text{ M H}_2\text{SO}_4$ (50:50 water/2-propanol). c: 10.0 mM NB in $2.0 \text{ M H}_2\text{SO}_4$ (50:50 water/2-propanol).

In the literature^{28,29} it is stated that the addition of organic additives caused various changes in the current potential curves. It was reported that the anodic peak and the cathodic peak decreased as the concentration of the organic additives was increased and that the cathodic peak was reduced at high concentrations.

In conclusion, there is no observed peak corresponding to the reduction of NB on Pb and Sn electrodes.

Preparative electrolyses results

The electrolyses were carried out in constant current conditions in a stationary solution and circulating neat catholyte electrolysis systems using carbon cloth, Pb, Sn and TiO_2/Ti electrodes.

Table 1 lists the stationary electrolysis data. The table indicates that the highest p-*Ap* and the lowest AN yields, as well as the highest selectivity of p-*Ap*, are obtained on a TiO_2/Ti electrode.

Table 1. The data relating to constant current stationary electrolysis of NB on various cathode materials. Catholyte: $2.0 \text{ M H}_2\text{SO}_4$ in 50:50 2-propanol/water + 0.234 mol NB , total volume; 200 mL , Anolyte: $2.0 \text{ M H}_2\text{SO}_4$, in 50:50 2-propanol/water, Anode: graphite, Temperature: $80 \text{ }^\circ\text{C}$, Q: 90312 C (4F mol^{-1}), I: 4 A .

Cathode Materials	Product yield				Conversion /%	Selectivity /%	
	p- <i>Ap</i>		AN			p- <i>Ap</i>	AN
	/mol	/%	/mol	/%			
Sn	0.094	40	0.082	35	75	53.3	46.7
Pb	0.082	35	0.129	55	90	38.9	61.1
Carbon cloth	0.129	55	0.070	30	85	64.7	35.3
TiO_2/Ti	0.140	60	0.059	25	85	70.6	29.4

The data for the circulating neat catholyte are given in Table 2. This table also indicates that the highest p-*Ap* yield and selectivity are also obtained with a TiO_2/Ti electrode.

Table 2. The data relating to the constant current circulating neat NB electrolysis system with various cathode materials. Catholyte: 2.0 M H₂SO₄ + 0.234 mol NB, total volume; 200 mL, Anolyte: 2.0 M H₂SO₄. All other conditions are as same as those listed in Table 1.

Cathode Materials	Product yield				Conversion /%	Selectivity /%	
	p-Ap		AN			p-Ap	AN
	/mol	/%	/mol	/%			
Sn	0.129	55.2	0.076	32.3	87.5	63.1	36.9
Pb	0.115	49.1	0.086	36.9	86.0	57.1	42.9
Carbon cloth	0.143	61.1	0.050	21.3	82.4	74.2	25.8
TiO ₂ /Ti	0.155	66.3	0.044	18.6	86.9	78.1	21.9

The separation and the determination of the products obtained in both types of electrolysis were carried out as follows: The unreacted NB was separated from the reaction medium by steam distillation, purified by ether extraction and dried over CaCl₂ after the evaporation of the ether. The remaining solution was neutralised with NH₄HCO₃ to pH 6-7 and re-subjected to steam distillation to separate the AN, which was extracted with the ether from the aqueous solution. The solution was then boiled with active C filtered and cooled down to 0 °C. The p-Ap crystals were filtered off, washed with benzene and 1% sodium bisulphite, recrystallised from hot water and dried in a vacuum desiccator (mp 188-189 °C lit.¹, mp 189.5-190 °C).

Conclusion

The best cathode material for the reduction of NB into p-Ap was TiO₂/Ti in both electrolyses. However, the yield was higher in the circulating neat catholyte process than in the stationary process. This can be explained by the decrease in the unreacted NB in the solution as a result of the continuous circulation of the NB over the cathode surface. The circulation of NB species over the electrode surface also prevents side reactions and therefore the formation of resinous products on the electrode surface. In addition, complications, such as the evaporation of the solvent at elevated temperatures and the dissociation of solvent molecules at high current values are avoided with the use of neat NB.

References

1. R.E. Kirk and D.F. Othmer, **Encyclopedia of Chem. Tech**, Vol. II, 422-439, Wiley Inc., New York, 1978.
2. L. Gattermann, **Ber. Dtsch. Chem. Ges.** **24**, 1884 (1893).
3. L. Gattermann and C. Koppert, **Chem. Ztg.** **17**, 210 (1893).
4. F. Darmstadler, **Z. Electrochem**, **10**, 486 (1904).
5. F. Darmstadler, **Z. Electrochem**, **11**, 274 (1905).
6. C.J. Thatcher, **US. Pat.** **1**, 501472 (1924).
7. A.S. McDaniel, L. Schneider and A. Ballard, **Trans. Faraday Electrochem. Soc.** **39**, 441 (1921).
8. B.B. Dey, T.R. Govindachari and S.C. Rajagopalan, **J. Sci. Ind. Res. India**, **4**, 574 (1946).
9. C.L. Wilson and H.V. Udupa, **J. Electrochem. Soc.** **99**, 289-294 (1952).
10. M. Fleischmann, I.N. Petrov and W.F.K. Wynne-Jones, **Proc. of the First Aust. Conf. on Electrochem**, Pergamon Press, pp.500-517, New York, 1965.

11. H.C. Rance and J.M. Coulson, **Electrochim. Acta**, **14**, 283-292 (1969).
12. J.E. Slaqer, **Ger. Pat.** **1**, 066, 589, (1959) (**Chem. Abst.** **55**, 15418i, 1966).
13. J.E. Slaqer and J. Mirza, **Fr. Pat.** **1**, 416, 966, (1965) (**Chem. Abst.** **64**, 6551c, 1966)
14. K. Jayaraman, K.S. Udupa and H.V.K. Udupa, **Transactions of the SAEST**, **12**, 143-149 (1977).
15. J. Marquez and D. Pletcher, **J. Appl. Electrochem.** **10**, 567-573 (1980).
16. P.S. Fedkiw and J.C. Chao, **AIChE Journal**, **31**, 1578-1580 (1985).
17. C. Ravichandran, S. Chellammal and P.N. Anantharaman, **J. Appl. Electrochem.** **19**, 464-465 (1989).
18. T.R. Nolen and R.S. Fedkiw, **J. Appl. Electrochem.** **20**, 370-376 (1990).
19. K. Polat, M.L. Aksu and A.T. Pekel, **J. Appl. Electrochem.** **32**, 217-223 (2002).
20. F. Beck and H. Shhult, **Electrochim. Acta.** **29**, 1569-1579 (1984).
21. R.S. Nicholson and I. Shain, **Anal. Chem.** **37**, 178-190 (1965)
22. T. Sone, Y. Tokuda, T. Sakai, S. Shinkai and O. Manabe, **J. Perkin Trans. II**, 298-302 (1981).
23. P. Subbiah., M. Noel., S. Chidambaram., and K.S. Udupa. **B. Electrochem.** **4**, 573-576 (1988)
24. D. Vasudevan, S. Chellammal and P.N. Anantharaman, **J. Appl. Electrochem.** **21**, 839-841 (1991).
25. F. Beck and M. Gabriel, **Angew. Chem. Int. Ed.**, **14**, 771-772 (1985).
26. C. Ravichandran, D. Vasudevan and P.N. Anantharaman, **J. Appl. Electrochem.** **22**, 1192-1196 (1992).
27. C. Ravichandran, D. Vasudevan and P.N. Anantharaman, **J. Appl. Electrochem.** **22**, 179-181 (1992).
28. M.P.J. Brennan and N.A. Hampson, **Electroanal. Chem.** **54**, 263-268 (1974).
29. T.F. Sharp, **J. Electrochem. Soc.** **116**, 1639-1642 (1969).