

1-1-2007

A Combinatorial Approach of Real GA & Fuzzy to ATC Enhancement

HOSSEIN FARAHMAND

MASOUD RASHIDINEJAD

ALI AKBAR GHARAVEICI

Follow this and additional works at: <https://journals.tubitak.gov.tr/elektrik>



Part of the [Computer Engineering Commons](#), [Computer Sciences Commons](#), and the [Electrical and Computer Engineering Commons](#)

Recommended Citation

FARAHMAND, HOSSEIN; RASHIDINEJAD, MASOUD; and GHARAVEICI, ALI AKBAR (2007) "A Combinatorial Approach of Real GA & Fuzzy to ATC Enhancement," *Turkish Journal of Electrical Engineering and Computer Sciences*: Vol. 15: No. 1, Article 6. Available at: <https://journals.tubitak.gov.tr/elektrik/vol15/iss1/6>

This Article is brought to you for free and open access by TÜBİTAK Academic Journals. It has been accepted for inclusion in Turkish Journal of Electrical Engineering and Computer Sciences by an authorized editor of TÜBİTAK Academic Journals. For more information, please contact academic.publications@tubitak.gov.tr.

A Combinatorial Approach of Real GA & Fuzzy to ATC Enhancement

Hossein FARAHMAND¹, Masoud RASHIDINEJAD², Ali Akbar GHARAVEISI²

¹*Energy Research Group, International Center for Science and Technology, Mahan-IRAN*

²*Power System Research Center, Shahid Bahonar University of Kerman, Kerman-IRAN*

e-mail: mrashidi@mail.uk.ac.ir • mrashidinejad@yahoo.co.uk

Abstract

Under new de-regulated environment an open access to transmission system seems to be desired. Transmission system operators (TSOs) are encouraged to use the existing facilities more efficiently. This paper focuses on study of the best location for SVC as a FACTS device to improve voltage profile as well as maximum available transfer capacity (ATC) in order to achieve lower prices.

Real genetic algorithm (RGA) is used for optimization technique and analytical hierarchy process (AHP) associated with fuzzy sets to obtain priority vector for each alternative to evaluate the GA fitness. The effectiveness of the proposed methodology is shown through case studies.

Key Words: *Available Transfer Capacity (ATC), Analytical Hierarchy Process (AHP), Real Genetic Algorithm (RGA), Flexible AC Transmission Systems (FACTS), Electricity Markets.*

1. Introduction

The aim of electric industry restructuring is to promote competitive markets for electric power trading. Under new environment, the main consequence of the nondiscriminatory open-access requirement is the substantial increase in power transfers. Adequate available transfer capacity (AATC) is needed to ensure all economic transactions, while sufficient ATC is needed to facilitate electricity market liquidity. It is necessary to maintain economical and secure operation over a wide range of system operating conditions and constraints. However, tight restrictions in the construction of new facilities due to the economic, environmental, and social problems, reduces the operational alternatives. It may sometimes lead to a situation that the existing transmission facilities are intensively used. On the other hand it can be said that power suppliers will benefit from more market opportunities with reduced possibility of congestion incorporating power systems security enhancement. Maximum use of existing transmission assets will be more profitable for transmission system owners; and customers will receive better services with reduced prices [1]. Various ATC boosting approaches have been experienced via adjusting generators' terminal voltages, under load tap changers (ULTCs) and rescheduling generator outputs [2]. Based upon the NERC's definition of ATC and its determination [3], transmission network can be restricted by thermal, voltage and stability limits. On the other hand, it is highly recognized that, with the capability of flexible power flow [4], FACTS technology has introduced a severe impact to the transmission system utilization with regards to those three constraints. From the

steady state power flow viewpoint, networks do not normally share power in proportion to their ratings, where in most situations, voltage profile cannot be smooth. Therefore, ATC values are always limited by heavily loaded buses with relatively low voltage. As it is shown in [5], FACTS concept makes it possible to use circuit reactance, voltage magnitude, and phase angle as controls to redistribute line flow and regulate voltage profile. Theoretically FACTS devices can offer an effective and promising alternative to conventional methods of ATC enhancement. They will provide new control facilities, both in steady state power flow control and dynamic stability control [5, 6]. Controlling power flow in electric power systems without generation rescheduling or topological changes can improve the network performance considerably [7]. But, the economical capacity and the location of FACTS devices are also crucially important [8]. In this paper, suitable locations, as well as capital cost indices of FACTS devices from a static point of view has been studied, The method is based on the sensitivity criterion with respect to control parameters aimed to enhance the ATC. Reducing the costs of FACTS devices by smoothing the voltage profile is considered through the proposed methodology. Multi-objective optimization is handled incorporating real genetic algorithm (RGA), analytical hierarchical process (AHP) and Fuzzy sets. The proposed algorithm has been applied to a 9-Bus test system, and promising results have been obtained.

2. Problem Definition & Mathematical Modeling

This research focuses on multi-objective optimization to find the best location and best capacity of SVC to satisfy the goal function that includes three objectives: voltage profile, ATC value and SVC capital costs. Optimization process includes voltage profile improvement beside ATC enhancement at low cost.

2.1. Problem definition

As it is mentioned the problem is multi-objective optimization which can be represented as Equation 1:

$$F(x) = O_{voltage} + O_{ATC} + O_{cost} \quad (1)$$

Subject to :

$$|V_i|_{\min} \leq |V_i| \leq |V_i|_{\max}$$

$$S_{ij} \leq S_{ij}^{\max}$$

$$Q_{SVC} \leq Q_{MAX_{SVC}}$$

Where:

$O_{voltage}$: is voltage profile

O_{ATC} : is ATC value

O_{cost} : is SVC capital cost

S_{ij} : is apparent power flow in line ij.

$S_{ij\max}$: is thermal limit of line ij.

Q_{svc} : is SVC capacity (MVar)

In order to derive the impact of maximum possible capacity of SVC, the capacity range is kept between 0 and $Q_{MAX_{SVC}}$ while $Q_{MAX_{SVC}} = 500$ MVar.

2.2. Mathematical modeling

Mathematical model which is comprised of objective function and power flow equations including FACTS devices is defined in the following section.

Transfer capacity

NERC [3] has established a framework for determining ATC of an interconnected network for a commercially viable wholesale electricity markets. In principle, ATC is consisted of the following terms and definitions: total transfer capacity (TTC) is the maximum power transfer that causes no limit violations, while ETC is the sum of the existing transmission commitment between two areas. Transmission reliability margin (TRM) is the amount of transmission capacity necessary to ensure that the interconnected system is secure under a reasonable range of uncertainty. Capacity benefit margin (CBM) is the transmission capacity reserved by load serving entities to ensure access to generation from interconnected systems to meet the generation reliability requirements. ATC is defined as [3]:

$$ATC = TTC - TRM - ETC - CBM \quad (2)$$

Determination of TTC is the key component in ATC calculation. It is defined as the largest power transfer increase between the selected source/sink that transfers without violation of any security constraints, with or without any contingency. In this paper, thermal and voltage limits are considered for TTC calculation. In other words, TTC is determined by the system's thermal, voltage and stability limits. Although various mathematical methods and algorithms have been developed for calculating TTC, only three of them are practically applicable for large-scale realistic applications. These methods may be listed as follows:

- Repeated Power Flow (RPF) method [9].
- Continuation power flow (CPF) method [9, 10].
- Transfer-based security constrained OPF (TSCOPF) method.

The RPF, which is based on repeated solutions of the power flow equations, is applied to calculate TTC in this paper. Mathematical formulation of TTC using RPF can be expressed as follows:

$$P_{Di} = P_{Di}^{\circ}(1 + \lambda k_{Di}) \quad (3)$$

Where:

P_{Di} : is real load demand at bus i.

P_{Di}° : is original real load demand at bus i.

λ : is a scalar parameter representing.

k_{Di} : is a constant to specify the rate of changes in load as λ varies.

Reactive power demand (Q_D) is incremented in order to keep power factor as a constant value. In this regard, TTC level in each case (normal or contingency) is calculated as follows:

$$TTC = \sum_{i \in \text{sin } k} P_{Di}(\lambda_{\max}) - \sum_{i \in \text{sin } k} P_{Di}^{\circ}$$

where $\sum_{i \in \text{sink } k} P_{Di}(\lambda_{\max})$ is the sum of load in sink area when $\lambda = \lambda_{\max}$ and $\sum_{i \in \text{sink } k} P_{Di}^o$ is the sum of load in sink area when $\lambda = 0$.

The implementation of RPF can provide part of P-V, Q-V curves, which offer the possibility of taking voltage stability into account [11]. Voltage profile can be specified from power flow information while SVC capital cost is dependent on SVC capacity. Mathematical model that should be included at this stage is SVC model which can be described as follow:

SVC Model

SVC as a FACTS controller is a shunt compensation component. When it is connected to a certain point of a network, the related bus will be taken as a PV bus with zero real power output, but the regulated voltage domain would be specified. In this study the required reactive power and also the admittance of SVC will be determined correspondingly. While the admittance matrix will be revised as follows:

$$Y'_{\text{bus}} = Y_{\text{bus}} + \begin{bmatrix} 0 & 0 & 0 & \dots & 0 & 0 & 0 \\ 0 & Y_{\text{svc}} & 0 & \dots & 0 & 0 & 0 \\ 0 & 0 & 0 & \dots & 0 & 0 & 0 \\ \dots & \dots & \dots & \dots & \dots & \dots & \dots \\ 0 & 0 & 0 & \dots & 0 & 0 & 0 \\ 0 & 0 & 0 & \dots & 0 & 0 & 0 \\ 0 & 0 & 0 & \dots & 0 & 0 & 0 \end{bmatrix} \quad (4)$$

In fact, power flow equations can be rewritten as Equations (5).

$$\begin{aligned} P_{Gi} - P_{Di} - \sum_{j=1}^n |V_i| |V_j| (G_{ij}(\text{SVC}) \cos \delta_{ij} + B_{ij}(\text{SVC}) \sin \delta_{ij}) &= 0 \\ Q_{Gi} - Q_{Di} - \sum_{j=1}^n |V_i| |V_j| (G_{ij}(\text{SVC}) \sin \delta_{ij} - B_{ij}(\text{SVC}) \cos \delta_{ij}) &= 0 \end{aligned} \quad (5)$$

where :

P_{Gi} and Q_{Gi} : real and reactive power generation at bus i.

P_{Di} and Q_{Di} : real and reactive load demand at bus i. n: is the bus number of the system.

$|V_j|$ and $|V_i|$: voltage magnitude at bus i,j.

$G_{ij}(\text{SVC})$, $B_{ij}(\text{SVC})$: real and imaginary parts of the ij^{th} element of Y_{bus} matrix including SVC

2.3. Solution algorithm

In this paper an optimization algorithm is implemented via hybrid technique, which includes RGA, Fuzzy sets as well as AHP. The method is based upon a sensitivity criterion with respect to SVC location and SVC capacity as control parameters aimed to satisfy objectives and constraints in the goal function.

GA is a powerful and broadly applicable stochastic search and optimization technique based on principle of evaluation theory, which that represents a good solution for problems those are difficult to be solved using conventional methods. Especially with regards to solve multi-objective optimization problem

GA can be candidate as a good optimizer. Unlike binary (ordinary) GA, RGA does not need coding and decoding process, while it can be pointed out that RGA is much faster and simpler than binary GA. Because of this reason RGA is selected here to implement the optimization technique where the detailed descriptions are provided in [12,13].

Fitness evaluation is one of the most important parts in genetic algorithm, where in this research fuzzy numbers and AHP criterion is applied to evaluate fitness values. A fuzzy logic based approach is sometimes essential to deal with a certain problem and preferred over a probabilistic approach, which can not manage ambiguous variables. Fuzzy numbers are preferred in satisfying conflicting objectives in a decision problem, especially if unequal important factors are needed to be taken into consideration [14]. In the proposed approach the combination of fuzzy sets and AHP technique is used to calculate fitness of overall objective.

In the following the structure of RGA will be described in a simple fashion.

2.4. Structure of real genetic algorithm

In genetic algorithm, individuals are simplified to a chromosome that includes control variables of the problem. The value of an individual is called fitness which is corresponding to the objective function value that should be optimized [12,13]. Figure 1 shows the flow chart of the proposed algorithm that is implemented in this research. As it is mentioned RGA is selected for optimization process to improve the voltage profile as well as enhancing ATC considering lower SVC capital costs.

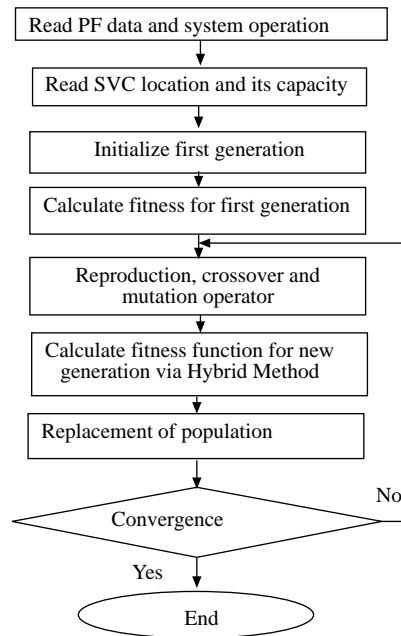

Figure 1. RGA flow Diagram.

The major issues of RGA can be addressed in crossover as well as mutation stages, where in the following these stages are explained in details.

2.5. Crossover and mutation

Crossover and mutation of RGA are different from ordinary (binary) GA. In this paper the following convex crossover technique [12] is implemented:

$$\begin{aligned} O_1 &= \lambda_1 P_1 + (1 - \lambda_1) P_2 \\ O_2 &= \lambda_2 P_2 + (1 - \lambda_2) P_1 \quad \lambda_1, \lambda_2 \in [0, 1] \end{aligned} \tag{6}$$

where P_1, P_2 are the two parents, O_1, O_2 are their two offspring. λ_1, λ_2 are uniform random number generators. Here it is assumed that for a given parent P , if the gene P_k is selected for mutation, then the resulting gene will be selected with equal probability from the two choices. This statement can be represented by Equation 7 [13].

$$\begin{aligned} O_K &= P_K - r(P_K + a_k)\left(1 - \frac{t}{T}\right)^b \\ O_K &= P_K + r(b_k - P_K)\left(1 - \frac{t}{T}\right)^b \end{aligned} \tag{7}$$

where a_k and b_k are lower and upper bands of P_k and r is a uniform random number chosen in the range of $(0, 1)$. t is the number of current generation, T is the maximum number of generation and b is an exponential power determining the degree of non-uniformity.

2.6. Evaluation of Fitness Value via Hybrid Technique

In this paper as it is mentioned a hybrid technique is use for calculating fitness value with regards to a multi-objective optimization model is proposed. It includes fuzzy numbers to conform qualitative nature of decision factors, characterized by the general memberships of $\mu_o(x): X \rightarrow [0,1]$. AHP is applied to determine the importance of various alternatives [15,16].Therefore the fitness value will be evaluated through the following formula:

$$Fitness = \mu_{c_1}^{w_1}(x) + \mu_{c_2}^{w_2}(x) + \dots + \mu_{c_N}^{w_N}(x) \tag{8}$$

Where μ_{c_i} is fuzzy membership of i^{th} objective participated in goal function and w_i is the priority value of i^{th} objective that is appeared as positive scalar value obtained from AHP.

3. Case Study & Solution Results

The study has been conducted on an IEEE 9-bus case, where the single line diagram of this system is depicted in Figure 2. The system is divided into two areas, which are shown by dashed lines while ATC will be calculated between area 1 and area 2. Base values are assumed to be 100 MVA and 345 kV. As it can be seen form Figure 2, it has three generators and two loads which are concentrated in area 2. However the main aim of this paper is to enhance the ATC from the generating area (area1) to sink area (area2). These results are eventually leaded to use the potential of transmission system more in comparison considering various conditions.

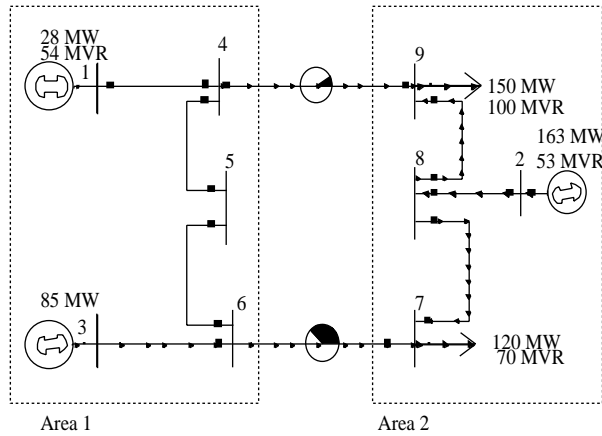

Figure 2. IEEE 9-bus system.

The proposed method has been tested separately on a case study in two different conditions where objective values are determined for both situations. In this regard, ATC value from area 1 to area 2 is calculated as: $ATC = TTC - Base\ Case\ Value$, in which the base case value is equal to 277.95 MW. A pre-assumed transfer limited condition is established at which the transfer has been increased to such a value that there is a binding security limit. In this case the binding security limit is voltage collapse at bus 9. Further power transfer in a specified direction would cause a violation of the binding limit and compromise system security. In this respect, the P-V curve is shown in Figure 3 where voltage collapse is occurred at bus 9 while voltage magnitude is 0.5762 pu and real power load is 282.7 MW at this bus.

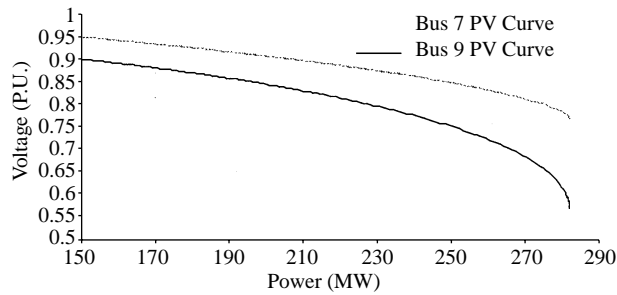

Figure 3. P-V Curves for Buses 9 and 7.

ATC value for each line in the base case can be derived from Table 1, where ATC between area 1 and 2 is the sum of power transfer from line 6-7 and line 4-9 is equal to 277.95 MW.

Table 1. ATC value for all system lines.

From Bus #	To Bus #	ATC (MW)
1	4	300.5261
4	5	32.4837
5	6	30.6299
3	6	0.0000
6	7	99.7537
7	8	39.1912
8	2	0.0000
8	9	39.4514
4	9	178.1963

Another objective is voltage profile where Figure 4 shows the voltage profile for base case without employing SVC. As it can be seen from this figure the minimum voltage magnitude is 0.9048 pu at bus 9.

In another condition, one of the two tie lines between two areas is disconnected (line 6-7) where an assumed contingency is applied. For this condition ATC value between two areas is 152.488MW and the minimum voltage is 0.887 pu at bus 7 where voltage profile is shown in Figure 5.

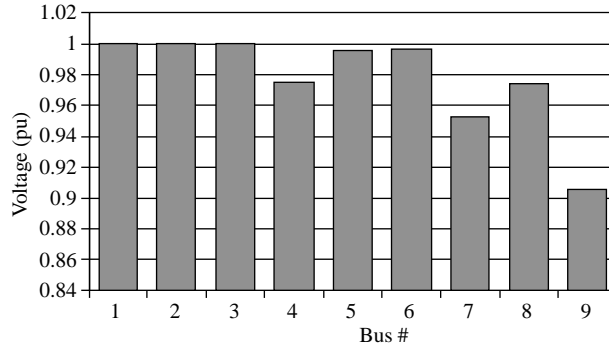

Figure 4. Voltage Profile for Base Case without Employing SVC.

As it is mentioned fuzzy numbers are used to conform qualitative nature of decision issues characterized by the general memberships. In order to apply this idea the membership of each objective, considering their natural characteristics, should be introduced. In this regard, a typical membership functions for bus voltages is depicted in Figure 6.

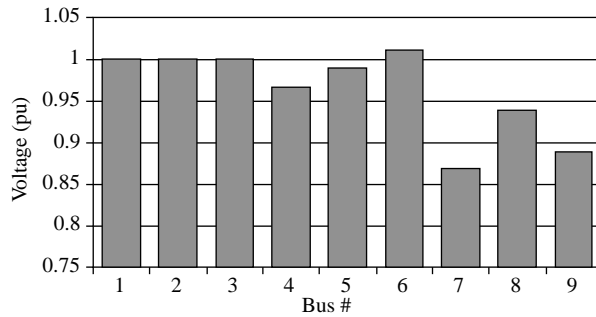

Figure 5. Voltage Profile for System with Contingency.

Figure 7 shows the membership of desired value of ATC between two areas that can be specified by system designers.

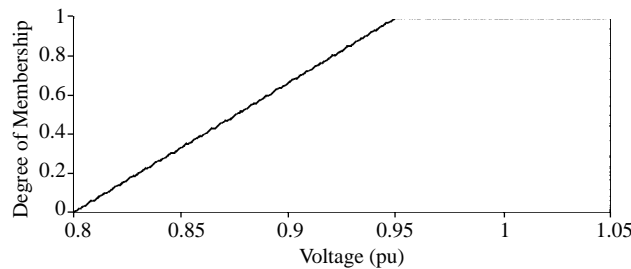

Figure 6. Membership of Bus Voltages.

The membership function for investment costs of SVC is shown in Figure 8, where it is used to evaluate the degree of lower price of this device.

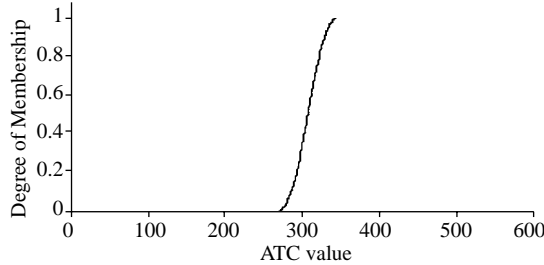

Figure 7. Membership of Desired ATC.

The desired value of ATC should have minimum achievable costs of SVC and best voltage profile when SVC is used. Moreover, voltage profile is assumed highly more important than ATC and absolutely important than SVC costs, while ATC is more important than the costs of SVC. The priority vector for objectives is obtained via some matrix manipulations that is $W = [0.97337 \ 0.21867 \ 0.068775]^T$. Fitness value of RGA is calculated applying fuzzy-AHP method as below [15]:

$$\text{Fitness} = \{ \mu_1^{0.97337}(x) + \mu_2^{0.21867}(x) + \mu_3^{0.068775}(x) \}$$

This procedure is used to determine the fitness of RGA for each chromosome considering the importance of each constraint as well as objectives. This process is continued until the results converge to one point that is ending condition for RGA. By using RGA the best location and the capacity of SVC is obtained aimed to reach the best voltage profile associated with improved ATC. For base case, the best location of SVC is bus 9 where the optimum capacity of it is 159.5 MVar. By considering such an SVC in a specified location the bus calculated voltage profile is illustrated in Figure 9. The minimum voltage is 0.981 pu at bus 7, which is improved significantly and the ATC value is 347.957 MW which is considerably improved.

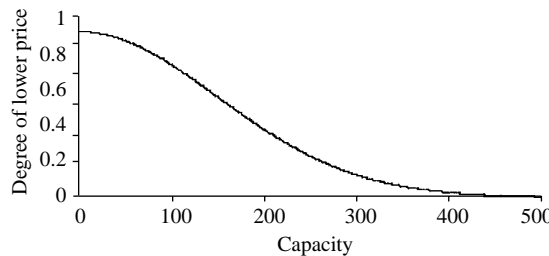

Figure 8. Membership of SVC Capital Costs.

Moreover, Figure 10 shows the variation of ATC value against the number of generation that guarantee a satisfactory convergence of RGA.

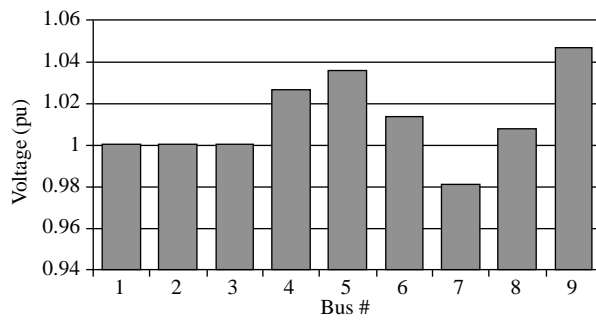

Figure 9. Voltage Profile for Base Case Including SVC.

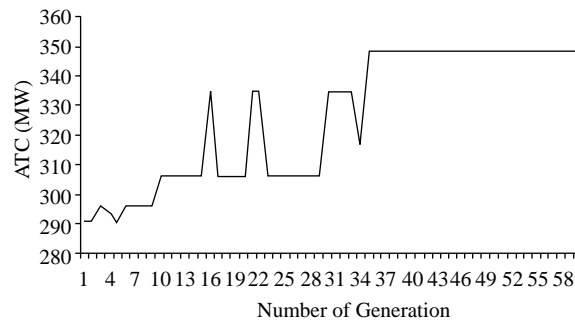

Figure 10. Variation of ATC Versus Number of Generation (Base Case).

The best location of SVC via RGA for the case where contingency is implemented is bus 8 with the optimum capacity of 202.6351 MVAR, in which bus voltage profile is shown in Figure 11.

Membership function of ATC between two areas in this scenario is considered similar to Figure 12. The minimum voltage is 0.947 pu at bus 9 and the ATC value at this condition is 192.0122 MW, which is significantly enhanced.

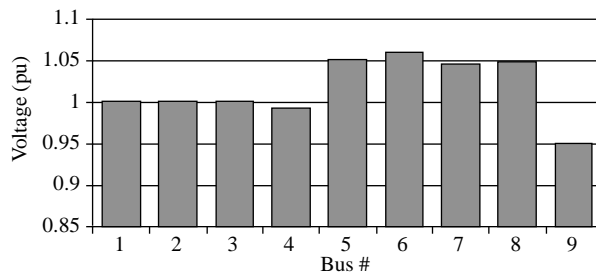

Figure 11. Voltage Profile for System with Contingency Including SVC.

Search process guarantees a good convergence that is depicted in Figure 13.

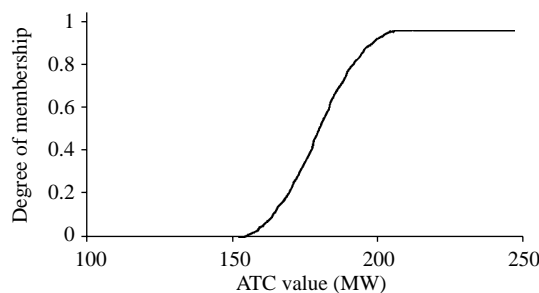

Figure 12. Membership of Desired ATC.

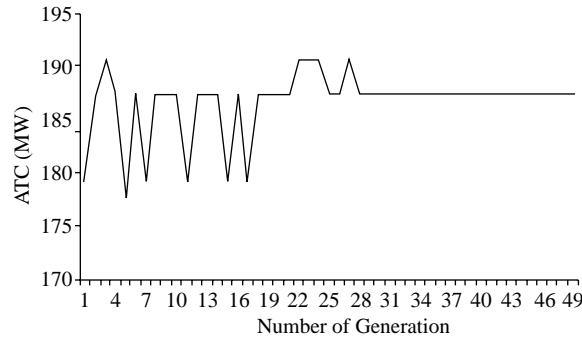

Figure 13. Variations of ATC Versus Number of RGA Generation (Contingency Case).

4. Conclusions

Improving of ATC is an important issue in the current de-regulated environment of power systems. ATC can be limited usually by heavily loaded circuits and buses with relatively low voltages. It is well known that FACTS technology can control voltage magnitude, phase angle and circuit reactance. Using these devices may redistribute the load flow regulating bus voltages. Therefore, it is worthwhile to investigate the impact of FACTS controllers on the ATC. This paper presents the ATC calculation using SVC based on repeated AC power flow method. A new application of RGA combined with AHP and Fuzzy sets is proposed in the present research. The effect of an SVC on the ATC enhancement is studied and demonstrated through case studies. It is shown that installing SVC in the proper location will improve voltage profile as well as ATC. Results through the implementation of different scenarios are satisfactory. Further studies can be suggested to investigate the other types of FACTS devices for such researches.

References

- [1] Y. Dai, J. D. McCalley, V. Vittal, "Simplification, expansion and enhancement of direct interior point algorithm for power system maximum loadability," Proc. 21st Int. Conf. Power Ind. Comput. Applicat, pp. 170-179, 1999.
- [2] E. De Tuglie, M. Dicorato, M. La Scala, "A static optimization approach to assess dynamic available transfer capability," Proc. 21st Int. Conf. Power Ind. Comput. Applicat, pp. 238-246, 1999.
- [3] North American Electric Reliability Council (NERC), "Available transfer capability definition and determination," Rep., June 1996.
- [4] Y. Xiao, Y. H. Song, Y. Z. Sun, "Available Transfer Capability Enhancement Using FACTS Devices," Proceedings of the 2000 IEEE/PWS Summer Meeting,, Seattle, vol. 1, pp. 508-515, July 2000.
- [5] Y. H. Song, A. T. Johns, Flexible AC Transmission Systems (FACTS), Eds., Inst. Elect. Eng. Power and Energy Series 30, Chap.1, 1999.
- [6] M.EREMIA, "Introduction to FACTS and A.I: A challenge for power systems engineers", ERASMUS IP, Bucharest Romania, 27 May-7, June 2002.
- [7] G. D. Galiana et al, "Assessment and control of the impact of FACTS devices on power system performance ", IEEE Trans on Power System, Vol. 11, No 4, pp. 1931-1936, Nov. 1996.
- [8] K. S. Verma, S. N. Singh, H. O. Gupta, "Facts Devices Location for Enhancement of TTC", Power Engineering Society Winter Meeting, IEEE, Volume 2 , pp 522 - 527, 28 Jan.-1 Feb. 2001.

- [9] G. C. Ejebe, J. Tong, J. G. Waight, "Available Transfer Capability Calculations ", IEEE Trans. Power Systems, Vol. 13, No. 4, pp 1512-1527, November 1998.
- [10] H. Chiang, A. J. Fluek, K. S. Shah, N. Balu, " CPFLOW : A Practical tools for Tracing Power System Steady-State Stationary Behavior Due To Load and Generation Variation", IEEE Trans. Power systems, Vol. 10 No. 2, May 1995.
- [11] Yan Ou, Chanan Singh, "Improvement Of Total Transfer Capability Using TCSC and SVC", Power Engineering Society Summer Meeting, 2001. IEEE, Volume: 2, 15-19 pp: 944 – 948, July 2001.
- [12] D. E. Goldberg, Genetic Algorithms in Search, Optimization and Machine Learning, Addison –Wesley Longman, 1989.
- [13] Wang Feng, G. B. Shrestha, "Allocation of TCSC Devices to Optimize Total Transmission Capacity in a Competitive Power Market", Power Engineering Society Winter Meeting, IEEE, Volume 2, pp 587 – 59328, Jan.-1 Feb. 2001.
- [14] Li-Xin Wang, A Course in Fuzzy Systems and Control, Prentice Hall, Chap. 2, 1997.
- [15] J. Nikoukaran, Using Software to Select Simulation Modeling Packages, PhD thesis, Brunel University.
- [16] T. L. Satty," A Scaling Method for Method for Priorities in Hierarchical Structure", Journal of Math Psychology, 15, pp. 234-281, 1997.
- [17] W. Ossadnik, O. Lange, "Theory and Methodology, AHP-based evaluation of AHP-Software", European Journal of Operational Research, 118, pp. 578-588, 1999.