

1-1-2008

## Online Tuning of Set-point Regulator with a Blending Mechanism Using PI Controller

ENGİN YEŞİL

MÜJDE GÜZELKAYA

İBRAHİM EKSİN

Ö. AYDIN TEKİN

Follow this and additional works at: <https://journals.tubitak.gov.tr/elektrik>



Part of the [Computer Engineering Commons](#), [Computer Sciences Commons](#), and the [Electrical and Computer Engineering Commons](#)

---

### Recommended Citation

YEŞİL, ENGİN; GÜZELKAYA, MÜJDE; EKSİN, İBRAHİM; and TEKİN, Ö. AYDIN (2008) "Online Tuning of Set-point Regulator with a Blending Mechanism Using PI Controller," *Turkish Journal of Electrical Engineering and Computer Sciences*: Vol. 16: No. 2, Article 6. Available at: <https://journals.tubitak.gov.tr/elektrik/vol16/iss2/6>

This Article is brought to you for free and open access by TÜBİTAK Academic Journals. It has been accepted for inclusion in Turkish Journal of Electrical Engineering and Computer Sciences by an authorized editor of TÜBİTAK Academic Journals. For more information, please contact [academic.publications@tubitak.gov.tr](mailto:academic.publications@tubitak.gov.tr).

# Online Tuning of Set-point Regulator with a Blending Mechanism Using PI Controller

Engin YEŞİL, Müjde GÜZELKAYA, İbrahim EKSİN, Ö. Aydın TEKİN

*Istanbul Technical University, Faculty of Electrical and Electronics Engineering,*

*Control Engineering Department, Maslak, 34469, İstanbul-TURKEY*

*e-mail: yesil@elk.itu.edu.tr, gkaya@elk.itu.edu.tr,*

*e-mail: eksin@elk.itu.edu.tr, tekin@elk.itu.edu.tr*

## Abstract

*In this paper, a new control structure that exploits the advantages of one degree of freedom (1-DOF) and two degree of freedom (2-DOF) control structures with an online tuned set-point regulator with blending mechanism (SPR-BM) is proposed. In this structure, the filtered output of the reference and the pure reference signals are blended so that the overall performance of the system is ameliorated with respect to load disturbance rejection and set-point following. Internal Model Control (IMC) based PI controller is used as the primary controller and the blending dynamics are determined with the aim of producing a system output that tries to match to the filtered reference signal. After performing certain manipulations through some approximations, the resulting blending dynamics turn out to be a constant within the range of zero and one. Then, an online intelligence is injected into SPR-BM that changes the blending constant between its extreme values. The effectiveness of the proposed structure is shown both on a simulation example and on a PT-326 heat transfer process trainer experimental setup.*

**Key Words:** *Set-point regulator, two degrees of freedom (2-DOF) control structure, PI controllers, internal model control (IMC), disturbance rejection, heat transfer.*

## 1. Introduction

Automatic control strategies force physical systems to behave in prescribed ways using the error value that is the difference between the system output and the desired reference input. This idea gives rise to error feedback control systems shown in Figure 1(a). Since the only signal processor is the controller, this classical control structure is also known as a one degree of freedom (1-DOF) control structure [1].

In recent times, there has been considerable interest in more general control structures. In the two degree of freedom (2-DOF) case, the reference input is processed by the filter  $F(s)$ , and the classical error is processed by the primary controller  $C(s)$ , and the related control system structure is shown in Figure 1(b). The pre-filter  $F(s)$  is used as the second DOF to weigh the set-point change in a desirable manner. In literature, there are many applications that use 2-DOF control structure and is often known as a model following control [2].

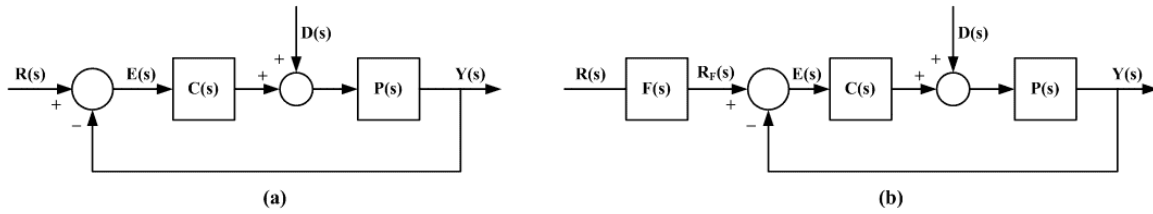

Figure 1. (a) 1-DOF control structure, (b) 2-DOF control structure.

Since PID controllers assure satisfactory results for a large range of processes, and due to the simplicity of their structures, they still often represent the best solution from a cost/benefit ratio point of view [3]. Therefore, the controller  $C(s)$  used in 2-DOF control structure is mostly a PID controller. In [4] and [5], a special form of PID was introduced to decouple the set-point response and disturbance response from each other using three weighting parameters.

Many different methods are proposed in order to obtain the proper weighting parameters [6–11]. A variable set-point weighting scheme with an adaptation mechanism is proposed in [12]. A fuzzy logic based set-point weight tuning method for PID controllers is proposed in [13]. A first order plus dead time filter  $F(s)$  is used to design a PID plus feed forward controller in [14]. Zhong [15] proposed a 2-DOF PID type controller incorporating Smith predictor and a prefilter  $F(s)$ . Similarly, a simple 2-DOF dead-time compensator (DTC) that involves a reference filter  $F(s)$  is proposed in [16]. Precup [17] proposed PI and PID parametric conditions to guarantee the robust stability of the closed-loop system with respect to parametric variations of the plant and a reference filter  $F(s)$  is recommended to improve the control system performance. A 2-DOF control structure that is based on coefficient diagram method (CDM) is introduced in [18]. Most recently, Kaya [19] introduced a simple approach to get parameters of PI-PD controller, and there used a prefilter in the equivalent PID structure of the PI-PD control structure.

In [20] a new set-point regulator in which the advantages of 1-DOF and 2-DOF control structures are both exploited is presented. In this set-point regulator structure, the filtered output of the reference and the pure reference signal are blended so that the overall performance of the system is ameliorated with respect to load disturbance rejection and set-point following. This structure is named as a set-point regulator with blending mechanism (SPR-BM). When the blending dynamics are set to be equal to zero, the proposed structure turns out to be a 2-DOF control structure; when the same dynamics are taken as unity, the proposed structure becomes 1-DOF control structure. The blending dynamics are determined with the aim of producing a system output that exactly matches to the filtered reference signal.

In this study, Internal Model Control (IMC) based PI controller [21] is preferred for the controller block of SPR-BM. Therefore, the resulting blending dynamics become a constant by an approximation. An online intelligence is injected into SPR-BM by changing the blending mechanism dynamics between its extreme values which are zero and one. The calculated value is achieved aiming an exact match of the system output with filtered reference signal. The effectiveness of the proposed online method is first shown based on a simulation example and then on heat transfer process trainer (PT 326) experimental setup.

## 2. Set-point Regulator with Blending Mechanism

The proposed control structure in which the set-point regulator possesses a blending mechanism is shown in Figure 2 [20]. The output of SPR-BM is then obtained as

$$R_F(s) = R(s)B(s) + Y_F(s)(1 - B(s)) \quad (1)$$

where  $R_F(s)$  is the filtered reference signal,  $R(s)$  is the set-point,  $Y_F(s)$  is the output of the filter  $F(s)$ . A similar idea of blending two signals with a ratio is previously presented in [22]. In SPR-BM,  $B(s)$  is the transfer function that determines the dynamics of the blending ratio between the signals  $R(s)$  and  $Y_F(s)$ .

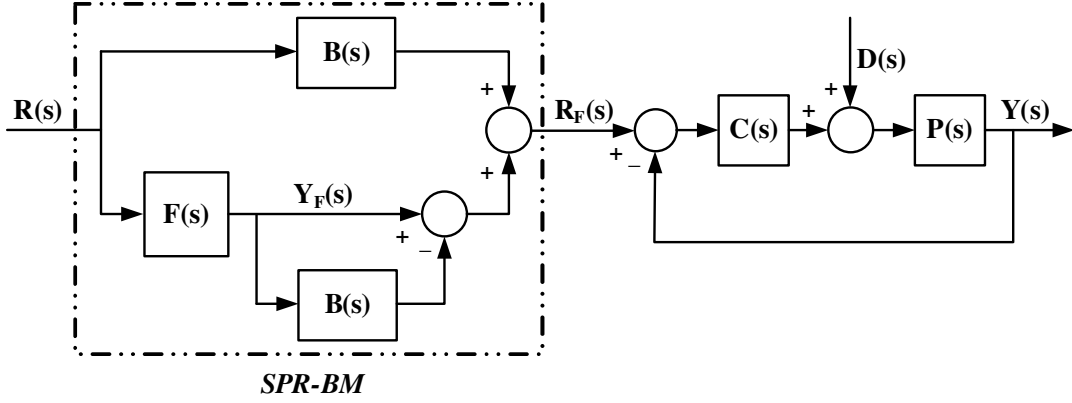

**Figure 2.** The structure of the set-point regulator with blending mechanism.

In this study, the filter, which represents the desired system output, is chosen as a first order plus dead time (FOPDT) system, with the transfer function

$$F(s) = \frac{1}{T_F s + 1} e^{-\theta s} \quad (2)$$

where  $\theta$  is the time delay and  $T_F$  is the time constant of the filter.

Typical signals for  $R(s)$  and  $Y_F(s)$  are given in Figure 3. If  $B(s)$  is zero, then the proposed structure turns out to be the simple 2-DOF control structure given in Figure 1(b). On the other hand, when  $B(s)$  is taken as unity, the proposed structure becomes 1-DOF control structure given as in Figure 1(a). It is then obvious that the new structure will produce a signal, namely  $R_F(s)$ , which is a blending of the two signals  $R(s)$  and  $Y_F(s)$ .

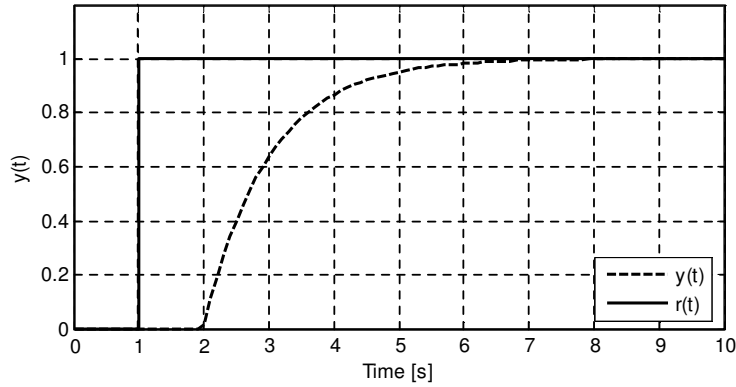

**Figure 3.** Typical signals of step set-point and the output of the FOPDT filter.

The system output signal can be obtained using the following equation:

$$Y(s) = \frac{C(s)P(s)}{1 + C(s)P(s)}R_F(s) + \frac{P(s)}{1 + C(s)P(s)}D(s). \quad (3)$$

When the disturbance signal  $D(s)$  is set equal to zero (assuming that there is no disturbance), the overall transfer function of the system with the new structure can be found via the relation

$$\frac{Y(s)}{R(s)} = \frac{C(s)P(s)}{1 + C(s)P(s)} [B(s) + F(s)(1 - B(s))], \quad (4)$$

where

$$F(s) = \frac{Y_F(s)}{R(s)}. \quad (5)$$

The ultimate goal in the determination procedure of  $B(s)$  is to produce a system output  $Y(s)$  that exactly matches to the signal  $Y_F(s)$  which is obtained from  $R(s)$  by the filter  $F(s)$ . For this reason, the transfer function from  $R(s)$  to  $Y(s)$  and the transfer function from  $R(s)$  to  $Y_F(s)$  are set equal to each other, and on this basis,  $B(s)$  is obtained as

$$B(s) = \frac{F(s)}{C(s)P(s)(1 - F(s))}. \quad (6)$$

The configuration of  $B(s)$  might be expressed as a single transfer function and performing some approximations on the elements forming it, one finally ends up with very simple and eligible forms (i.e. a simple constant) with a cost of a slight discrepancy from the exact match between  $Y(s)$  and  $Y_F(s)$  signals.

### 3. The Design of the Blending Dynamics of the Set-point Regulator Based on Internal Model Control

In this study, the plant  $P(s)$ , shown in Figure 2, is modeled as  $\tilde{P}(s)$  which is assumed to be a FOPDT system with transfer function

$$\tilde{P}(s) = \frac{K}{Ts + 1} e^{-Ls}, \quad (7)$$

where  $K$  is the static gain,  $T$  is the time constant, and  $L$  is the time delay of the system model. FOPDT is a well-known approximation for a wide range of systems and several approaches have been described, such as Zeigler-Nichols (Z-N) [23] and Cohen-Coon [24] for approximating plant models with this transfer function [25].

$C(s)$  in the proposed structure is chosen as the well-known PI controller which is given by

$$C(s) = K_C \left( 1 + \frac{1}{T_I s} \right), \quad (8)$$

where  $K_C$  is the proportional gain,  $T_I$  the integral time constant. The main duty of the feedback controller  $C(s)$  is to reject the disturbances quickly and to be robust to the parameter variations of the process. The controller parameters are obtained using Internal Model Control (IMC) design methodology [26–28]. The controller parameters of  $C(s)$  can easily be obtained via the relation

$$K_C = \frac{T}{K(L + \lambda)}, \quad T_I = T. \quad (9)$$

Inspecting equation (9), it is obvious that  $\lambda$ , which is the IMC filter time constant, is the only parameter left for the choice by the designer. Therefore, instead of tuning two controller parameters only one parameter is left to the designer. The filter  $F_{IMC}(s)$  is a user specified low-pass filter and usually chosen as

$$F_{IMC}(s) = \frac{1}{(\lambda s + 1)^n}. \quad (10)$$

In this study,  $n$  is chosen to be one. The IMC filter time constant achieves an appropriate compromise between the performance and the robustness issues in control system design. A smaller  $\lambda$  provides a faster closed loop response, but causes the manipulated control variable to become more vigorous, while a larger  $\lambda$  provides a slower but smoother response and a mild control effort [22]. For this study, maximum sensitivity measure is used for assigning  $\lambda$  parameter. As the sensitivity function can be given as

$$S(s) = \frac{1}{1 + P(s)C(s)} \quad (11)$$

and, the maximum sensitivity function is defined as

$$M_S = \max_{0 \leq \omega < \infty} \left| \frac{1}{1 + P(i\omega)C(i\omega)} \right| = \max_{0 \leq \omega < \infty} |S(i\omega)|. \quad (12)$$

$M_S$  is simply the inverse of the shortest distance from the critical point  $(-1, 0)$  to the Nyquist curve [2]. The suggested value of  $M_S$  is in the range of 1.3–2. When the controller parameter is tuned for higher values of  $M_S$  the output of the system gives a fast but oscillatory response for set-point changes and fast response to load disturbances. We have set the maximum disturbance rejection as our ultimate goal for primary controller design. For this reason, the allowable highest  $M_S$  value is assigned.

In this study, the dead time of the filter  $F(s)$  given in equation (2) has been taken same as the dead time of the system model  $\tilde{P}(s)$  given equation (7). When the PI controller transfer function given in equation (8) is substituted in equation (6) the following expression of blending dynamics  $B(s)$  are obtained:

$$B(s) = \frac{(L + \lambda)s}{T_F s + 1 - e^{-Ls}} \quad (13)$$

When first order Taylor series approximation is applied for the term  $e^{-Ls}$  in equation (13),  $B(s)$  is obtained as in (14), which is a very simple expression:

$$b = \frac{L + \lambda}{L + T_F} \quad (14)$$

The above approximation gives rise to a simple constant coefficient  $b$ , with a cost of a slight discrepancy from the exact matching of  $Y(s)$  and  $Y_F(s)$  [20]. The only parameter of the primary controller  $\lambda$  also becomes the main parameter in  $b$  as given in equation (14). The resulting controller parameters for the controller type PI is given in Table 1.

**Table 1.** The parameters of the SPR-BM control structure.

$K_C$	$T_I$	B
$\frac{T}{K(L+\lambda)}$	$T$	$\frac{L+\lambda}{L+T_F}$

Furthermore, the above-stated procedure for determining the blending dynamics  $B(s)$  might not be the only choice. For instance, the approximated choice of  $B(s)$  can be taken as the initial dynamics and an online intelligence may later be injected into SPR-BM structure that changes  $b$  in such a way that the direct effect of  $R(s)$  on the system response may be strengthened in order to achieve a faster system output performance.

## 4. Online Tuning of Blending Constant

In the previous section,  $B(s)$  has been determined so as to produce a system output  $Y(s)$  that aims to match to the signal  $Y_F(s)$  exactly.  $Y_F(s)$  has been derived by processing the reference signal  $R(s)$  via a filter  $F(s)$ . In this derivation procedure,  $B(s)$  becomes constant  $b$  when  $C(s)$  is chosen as PI type.

The only aim in the choice of the transfer function of the blending station  $B(s)$  might not be the exact match between the system output and the filtered reference signals; that is, other system performance criteria might be the goal of the designer. It has been already pointed out that two extreme cases in the choice of  $b$  occur to be as zero or one, which in turn, produces 2-DOF or 1-DOF control structures, respectively. Therefore, an online intelligence may obviously be injected into this new set-point regulator with blending mechanism so that we may exploit the beneficial sides of both control structures, namely 1-DOF and 2-DOF. This may be accomplished by changing the blending constant  $b$  between values of zero to one and the constant filter value calculated for the exact match of the system output with filtered reference output. It is a known fact that, when  $b$  is assumed to acquire the value of one (1), the system output will try to reach the reference in shortest time, but possibly with an overshoot. However, when the value of  $b$  value is taken to be zero, then system output will slow down but will not overshoot. Therefore, different algorithms may be produced that depends on the preferred system performance; that is, how and when the value of  $b$  will be changed between zero and one will determine the system behavior.

In this study, the online tuning algorithm is proposed in Table 2 so as to minimize the overshoot and fasten the system response for the case of  $C(s)$  taken as PI controller and resulting  $b$  as constant.

**Table 2.** The proposed online tuning algorithm.

<i>Step 1:</i>	Keep up with the constant value $b$ calculated by equation (14) until the system output reaches the 63% of the set-point value.
<i>Step 2:</i>	Set value $b$ to 0 (zero) until the first overshoot occurs.
<i>Step 3:</i>	Set value $b$ to 1 (one) thereafter.

It should be obvious that one might propose other online tuning algorithms in order to achieve different system performances.

## 5. Simulation

There are two free parameters to be chosen by the designer, namely,  $\lambda$  and  $T_F$ . In all of the simulation applications, the maximum sensitivity function  $M_S$  value is chosen to be 2 so that the system exhibits a fast disturbance rejection. Since the  $C(s)$  is the controller that only deals with the load disturbance rejection, the only tuning parameter  $\lambda$  of controller  $C(s)$  is calculated according to this  $M_S$  value. Next, the time constant of the filter  $F(s)$  has been chosen to be equal to the dead time of the system model.

In order to make a fair comparison of the outputs of the new proposed control structure with other control structures, five different performance measures are considered. The three of these performance measures are selected from the classical transient system response criteria; namely, the rise time  $T_r$ , the settling time  $T_s$  and the maximum overshoot  $M_p$ . The next two performance measures are considered to be

i) Integral Time Absolute Error (ITAE), which is defined as

$$\text{ITAE} = \int_0^{\infty} t |r(t) - y(t)| dt, \quad (15)$$

ii) Total Variation (TV) [25] of the control input, which is defined as

$$\text{TV} = \sum_{i=1}^{\infty} |u_{i+1} - u_i|. \quad (16)$$

The goal is to illustrate the advantages of online-tuned SPR-BM over SPR-BM without tuning for 1-DOF and 2-DOF control structures, on a high-order system.

The transfer function of the system is as follows:

$$P(s) = \frac{1}{(s+1)^4} \quad (17)$$

The model of the system is found to be

$$\tilde{P}(s) = \frac{1}{2.12s+1} e^{-1.88s} \quad (18)$$

using the well-known area method [2].

A PI controller is designed for this high-order system by using FOPDT model given in equation (18). IMC filter parameter  $\lambda$  is set to 0.8 for  $M_S = 2$ , and PI parameters are calculated as  $K_C = 0.791$ ,  $T_I = 2.12$ . Then, the filter time constant  $T_F$  is naturally chosen as 1.88, which is the time delay of the model. The initial blending constant  $b$  is calculated from equation (14) as 0.7128. In order to compare the performance of transient responses of the control systems, a unit step reference is applied. Then at thirtieth second a step load disturbance is applied to observe the disturbance rejection performance of the control structures.

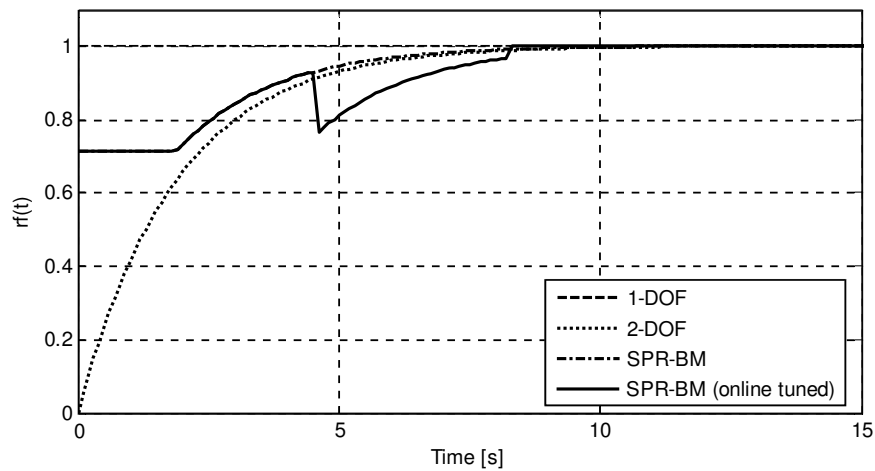

**Figure 4.** Reference signals of each control structures in the simulations.



The reference signals for 1-DOF, SPR-BM, and SPR-BM (online-tuned) are presented in Figure 4. The system outputs and the control signals are given in Figure 5. The performance comparisons of the control structures are presented in Table 3.

The reference signal produced by SPR-BM consists of two parts: A constant reference is produced during the dead time, and then a first order system which is the dynamic of filter  $F(s)$  is superposed for the rest of the time. As seen in Figure 4, the reference signal processed by SPR-BM is then tuned online two times at predefined times, as presented in Table 2.

2-DOF controller structure produces a reduction in the overshoot value as it is expected when it is compared to 1-DOF. As given in Table 3, 2-DOF controller structure reduces the overshoot to 12.2%. On the other hand, SPR-BM structure reduces the overshoot to 10.6% and it decreases the setting time about 32% when it is compared to 1-DOF. The ITAE value of SPRM-BM structure is less than classical 1-DOF and 2-DOF controller structure. SPR-BM has a low value of TV that shows that it has the smoothest control signal.

The proposed method of online tuning SPR-BM reduces the overshoot to less than 4% and the settling time is improved 40%. The rise time is as good as 2-DOF and SPR-BM. The control signal is still smooth and therefore it has the lowest TV value. Also, ITAE value is the best, as seen in Table 3. These results show that the online-tuning method further improves the performance of the SPR-BM control structure remarkably.

**Table 3.** Performance comparison of the simulation example.

	Rise $T_r$	Settling Time $T_s$	Overshoot (%)	ITAE	TV
1-DOF	3	15.2	23.5	44.55	0.2325
2-DOF	4.02	11.8	12.2	46.57	0.2129
SPR-BM	3.95	10.7	10.6	41.31	0.1774
SPR-BM (online tuned)	4.01	6.4	3.9	37.87	0.1759

Since the first degree controller  $C(s)$  only deals with the disturbance rejection, and all control structures have the same  $C(s)$  controller, the system outputs for a step load disturbance are the same as in Figure 5a.

## 6. Experiment

The PT-326 heat transfer process trainer used in this experiment has the basic characteristics of a large plant, with a tube through which atmospheric air is drawn by a centrifugal blower, and the air is heated as it passes over a heater grid before being released into the atmosphere.

The control objective for PT-326 is to regulate the temperature of the air. Temperature control is achieved by varying the electrical power supplied to the heater grid. Air is forced to circulate by a fan blower through a tube and heated at the inlet. The mass flow of air through the duct can be adjusted by setting the opening of the throttle. There is an energized electric resistance inside the tube, and due to the Joule effect, heat is released by the resistance and transmitted, by convection, to the circulating air, resulting in heated air. This process can be characterized as a non-linear system with a pure time delay. The pure time delay depends on the position of the temperature sensor element that can be inserted into the air stream at any one of the three points along the tube, spaced at 28, 140 and 280 mm from the heater and the damper

position. The system input,  $u(t)$ , is the voltage applied to the power electronic circuit feeding the heating resistance, and the output,  $y(t)$ , is the outlet air temperature, expressed by a voltage, between -10 and 10 V, issued from the transducer and conditioning electronics. A schematic of the heating process PT 326 is shown in Figure 6a.

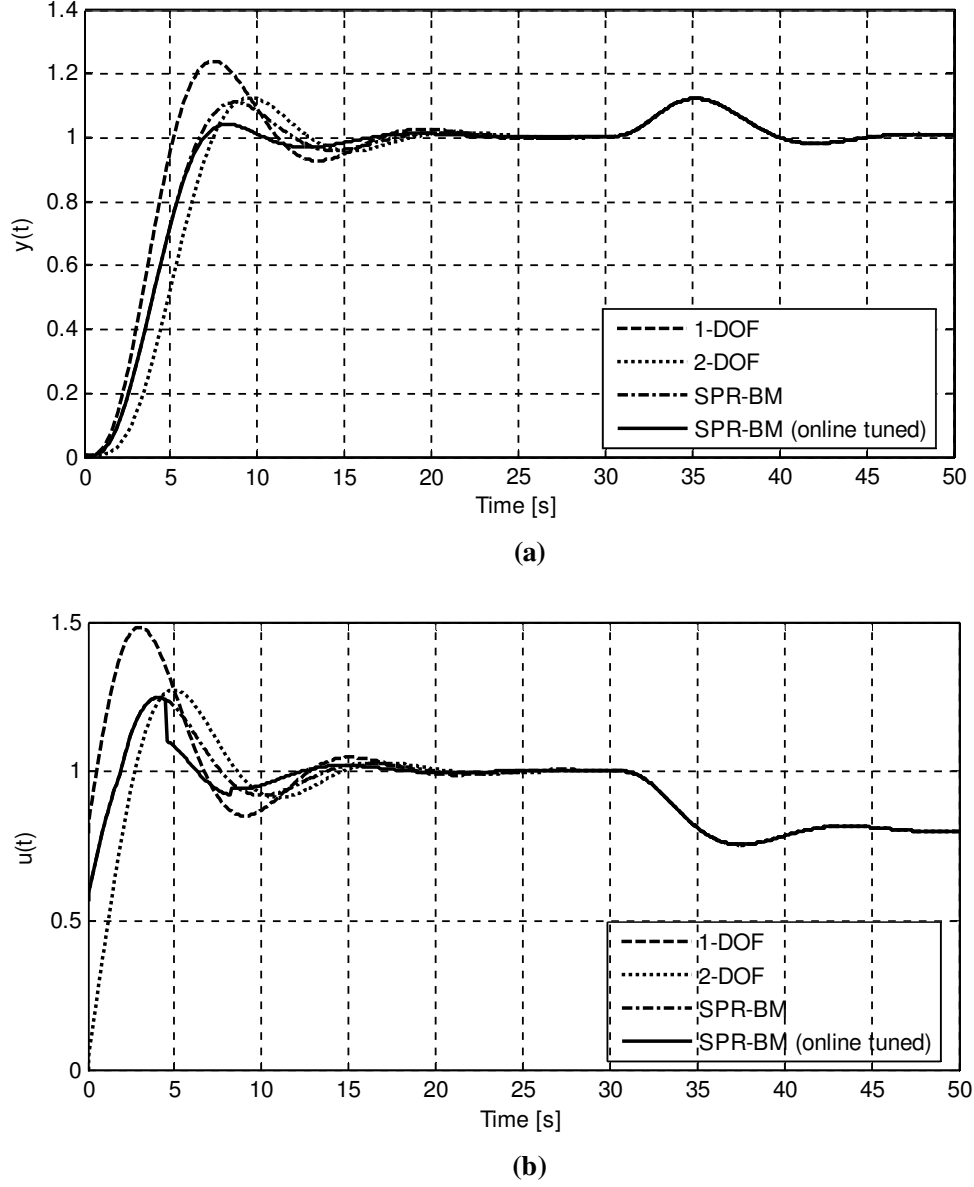

**Figure 5.** Simulation results: (a) System outputs, and (b) control signals.

The physical principle which governs the behavior of the thermal process in the PT 326 apparatus is the balance of heat energy. When the temperature in the air volume inside the tube is assumed to be uniform a linear system model can be obtained. Thus, the transfer function between the heater input voltage and the sensor output voltage can be obtained as

$$\frac{V_0(s)}{V_i(s)} = \frac{K}{Ts + 1} e^{-Ls}, \quad (19)$$

which is a first order plus dead time (FOPDT) system. Here the static gain is

$$K = \frac{1}{R}k_1k_2, \tag{20}$$

where  $1/R$  is a proportionality constant called as the thermal resistance,  $k_1$  is the proportional constant between the heater input voltage and the heat supplied by the heater, and  $k_2$  is the gain of the temperature sensor. The time constant of the system is

$$T = RC, \tag{21}$$

where  $C$  is the specific heat capacity of air.

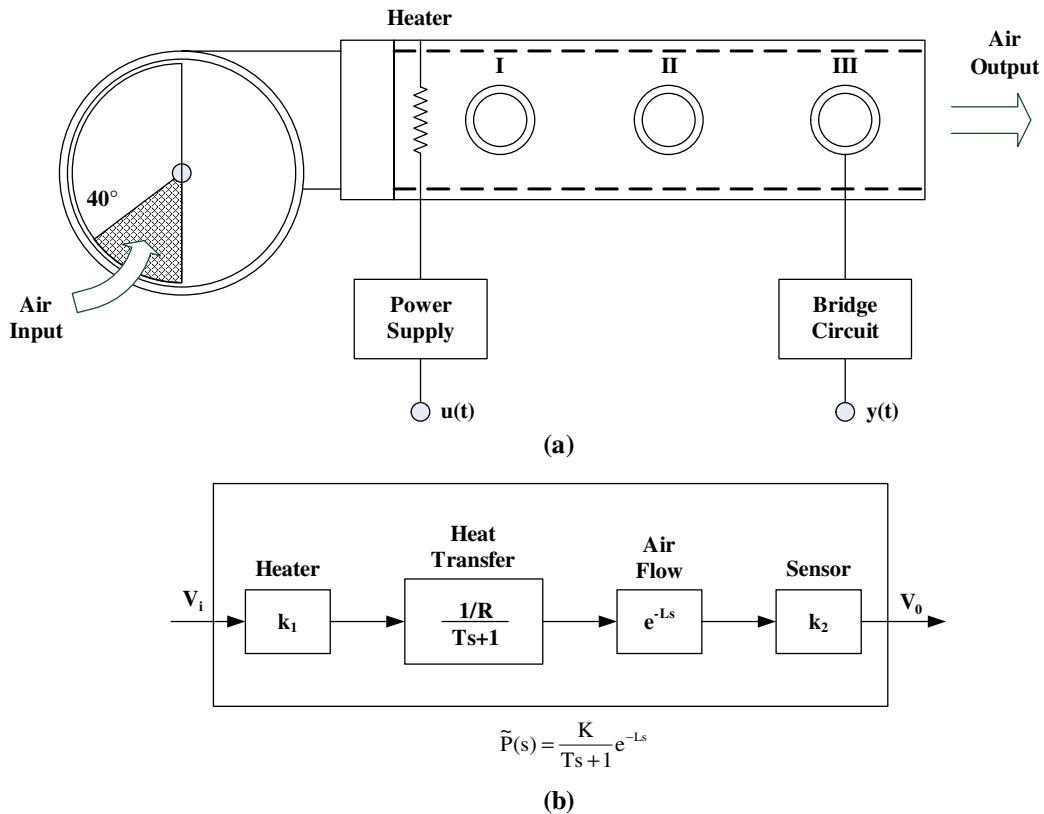

**Figure 6.** (a) Schematic illustration, (b) block diagram of PT 326.

Since the sensor is physically located at a distance from the heat source, the sensor output responds to a temperature change with a pure time delay  $L$ , which the time is spent by the flowing heated air to cover the distance between the heater and the sensor. This air stream heating process is being used by many researchers to check their new control strategies [29–34]. The block diagram showing of the heating process model is given in Figure 6b.

In order to show the advantages of the proposed SPR-BM structure over 1-DOF and 2-DOF the experimental setup given in Figure 7 is designed. A Microchip PIC 18F452 8-bit microcontroller running at 40 MHz clock frequency with 32 Kbytes of flash memory, and 1536 bytes of Random Access Memory (RAM), integrating a USART (Universal Synchronous Asynchronous Receive and Transmit) interface, a 10 bit Analog to Digital (A/D) conversion module, several timers are used in order to run the control algorithms and to keep the data coming from the thermal process PT-326.

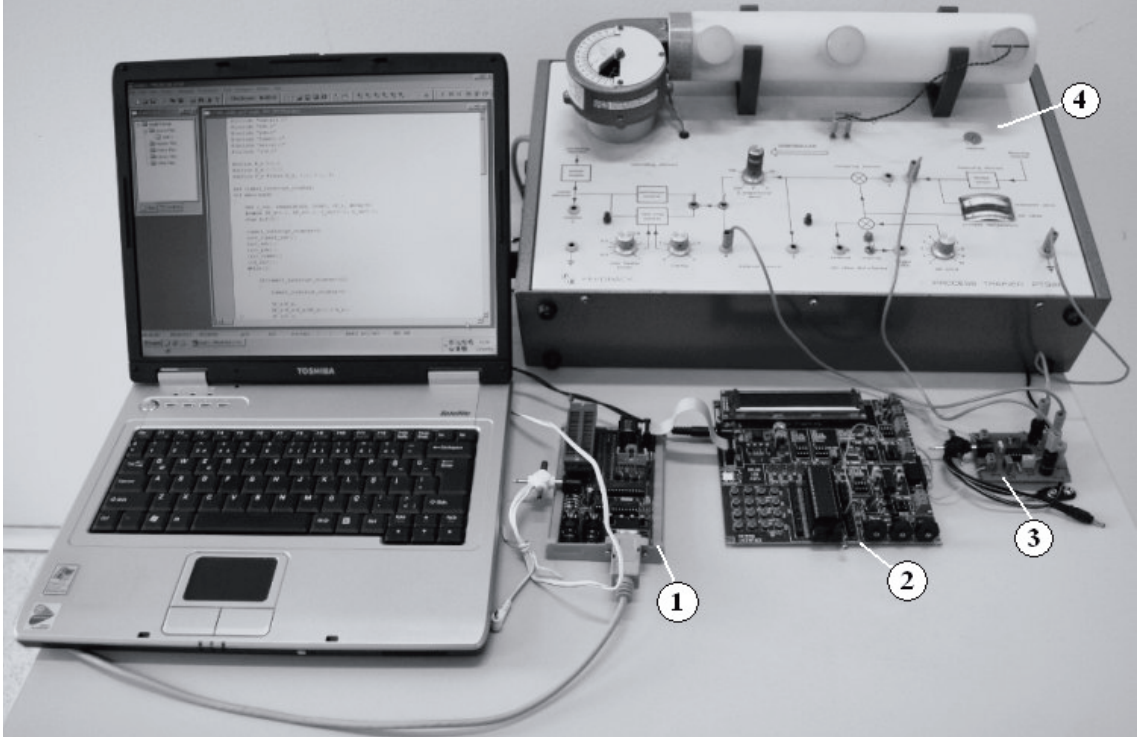

**Figure 7.** The experimental setup used in the study: (1) icdPIC in circuit debugger and programmer; (2) PICLab application/development board for PIC microcontrollers; (3) DC amplifier; (4) PT326 Process Trainer by FEEDBACK.

For the experiment, the damper position ( $\Omega$ ) is set to  $40^\circ$ , and the temperature sensor is placed in the third position. Then, a step input is applied to heating process PT-326 to obtain a model. By using the step response method the following transfer function is found:

$$\tilde{P}(s) = \frac{0.73}{0.6s + 1} e^{-0.3s} \quad (22)$$

The sampling time is 100 ms and the desired system output is set to  $35^\circ\text{C}$ . A load step disturbance is applied at the sixth second to see the disturbance rejection performances of the control structures.

The only control parameter  $\lambda$  is calculated to be 0.126 for  $M_S = 2$ . The controller parameters are then calculated as  $K_C = 1.93$ ,  $T_I = 0.6$ , from Table 1. The filter time constant is naturally chosen as  $T_F = 0.3$ , which is the time delay of the model. From equation (14) the blending dynamic are calculated as  $b = 0.71$ .

The system outputs and control signals are respectively presented in Figure 8a and Figure 8b for 1-DOF, 2-DOF, SPR-BM and online tuned version of SPR-BM structures. Moreover, the reference signals for all control structures are given in Figure 8c. In addition, the performance comparison of the experimental results is shown in Table 4. The output temperature has an overshoot when 1-DOF control structure is preferred. When 2-DOF control structure is used to lower the overshoot, the response slows down and settling time increases. The proposed SPR-BM structure has a very small overshoot when it is compared to 1-DOF and 2-DOF structures. The settling and rise time performances of the SPR-BM structure are also satisfactory.

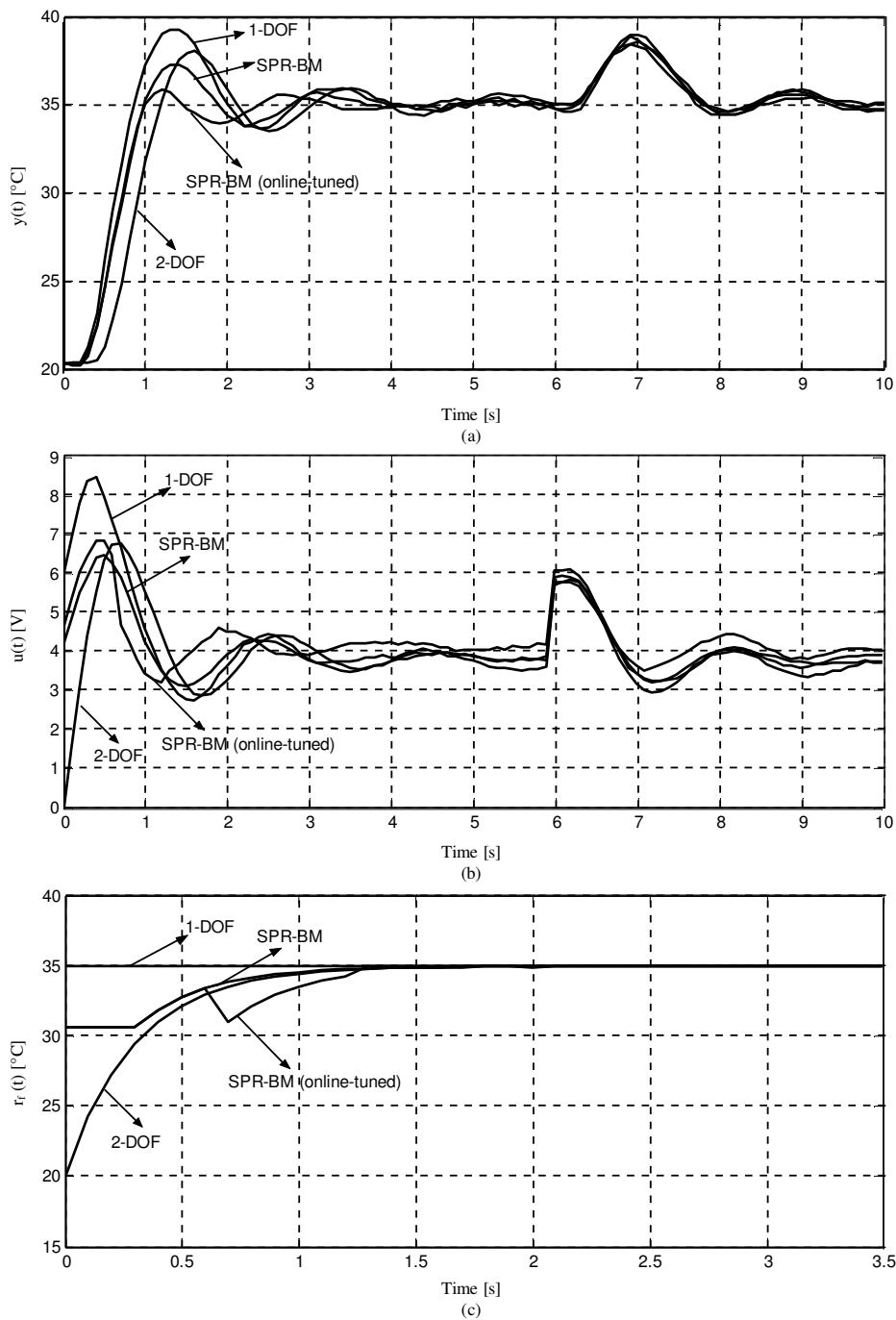

**Figure 8.** Experimental results: (a) system outputs, (b) control signals, (c) reference signals.

The proposed online tuned version of SPR-BM gives a system output with an overshoot of 1.8%, which is a remarkable improvement when it is compared to 1-DOF and 2-DOF structures. As a result of these improvements, ITAE performance measure is the smallest when online-tuned SPR-BM structures are used. The control signals of the proposed structure is smooth and TV value is better than the 1-DOF and 2-DOF structures.

**Table 4.** Performance comparison of the experimental results.

	Rise $T_r$	Settling Time $T_s$	Overshoot (%)	ITAE	TV
1-DOF	0.5	2.6	12.1	457.49	19.22
2-DOF	0.6	2.8	8.7	410.23	20.01
SPR-BM	0.6	2.3	6.3	374.97	14.87
SPR-BM (online tuned)	0.6	1.8	1.8	339.16	15.59

The obtained experimental results support the results of the simulation. The proposed online tuning method for SPR-BM improves the performans of SPR-BM in real-time implementations.

## 7. Conclusions

In this paper, an online tuned blending mechanism is proposed that exploits the advantages of one degree of freedom (1-DOF) and two degree of freedom (2-DOF) control structures. For the primary controller, Internal Model Control (IMC) based PI controller is used and the blending dynamics are determined with the aim of producing a system output that tries to match to the filtered reference signal. Forsaking slightly from the aim of the exact match between the system output and the filtered reference signal, one ends up with very simple constant  $b$  for blending dynamics  $B(s)$ . The set-point regulator with blending mechanism (SPR-BM) ameliorate the overall performance of the system with respect to load disturbance rejection and set-point following.

An online tuning method for  $b$  is developed to improve the system performance and a simulation example is presented to show the superiority of the online tuned version of the SPR-BM structure. In addition to the simulation, the effectiveness of the proposed structure is illustrated in real-time using the heat transfer process trainer (PT 326) experimental setup. The outputs of the experiment also show that the proposed online tuned SPR-BM structure combines the beneficial sides of 1-DOF and 2-DOF control structures by a simple blending idea in a much more effective way.

## References

- [1] J.W. Howze, S.P. Bhattacharyya, “Robust tracking, error feedback, and two-degree-of-freedom controllers”, IEEE Trans. Automatic Control, Vol. 42, No. 7, pp. 980–983, 1997.
- [2] K.J. Åström, T. Hägglund, PID Controllers Theory: Design and Tuning, Instrument of Society of America, Research Triangle Park, NC, 1995.
- [3] A. Visioli, “Fuzzy logic based tuning of PID controllers for plants with under-damped response”, Proceedings of IFAC Digital Control: Past, Present and Future of PID Control pp. 577–582, 2000.
- [4] E.A. Eitelberg, “A regulating and tracking PI(D) controller”, Int. J. Control, Vol. 45, pp.91–95, 1987.
- [5] P. Hippe, C. Wurmthaler, F. Dittrich, “Comments on a regulating and tracking PI(D) controller”, Int. J. Control, Vol. 46, No. 5, pp. 1851–1856, 1987.
- [6] R.J. Mantz, E.J. Tacconi, “Complementary rules to Ziegler-Nichols’ rule for a regulating and tracking controller”, Int. J. Control, Vol. 49, No. 5, pp. 1465–1471, 1989.

- [7] R.J. Mantz, E.J. Tacconi, "A regulating and tracking PID controller", *Ind. Eng. Chem. Res.*, Vol. 29, pp. 1249–1253, 1990.
- [8] K.J. Åström, T. Hägglund, "Automatic tuning of PID controllers based on dominant pole design", *Proceedings of IFAC Adaptive Control of Chemical Processes*, pp. 205–210, 1985.
- [9] C.C. Hang, K.J. Åström, W.K. Ho, "Refinements of the Ziegler-Nichols tuning formula", *IEE Proc. Control Theory App.*, Vol. 138, No. 2, pp. 111–118, 1991.
- [10] C.C. Hang, K.K.A. Sin, "A comparative performance study of PID auto-tuners", *IEEE Control Syst. Mag.*, Vol. 11, pp. 41–47, 1991.
- [11] A Leva, A.M. Colombo, "Method for optimising set-point weights in ISA-PID autotuners", *IEE Proc. Control Theory App.*, Vol. 146, No. 2, pp. 137–146, 1999.
- [12] C.C. Hang, L. Cao, "Improvement of transient response by means of variable set point weighting", *IEEE Trans. Ind. Electron.*, Vol. 43, No. 4, pp. 477–484, 1996.
- [13] A. Visioli, "Fuzzy logic based set-point weight tuning of PID controllers", *IEEE Trans. Systems, Man, and Cybernetics A*, Vol. 29, No. 6, pp. 587–592, 1999.
- [14] A. Visioli, "A new design for a PID plus feedforward controller", *J. Process Control*, Vol. 14, pp. 457–463, 2004.
- [15] Q.C. Zhong, H.X. Li, "2-degree-of-freedom proportional-integral-derivative-type controller incorporating the smith principle for processes with dead time", *Ind. Eng. Chem. Res.* Vol. 41, pp. 2448–2454, 2002.
- [16] J.E. Normey-Rico, E. Camacho, "A unified approach to design dead-time compensators for stable and integrating processes with dead-time", *IEEE Trans. Automatic Control*, Vol. 47, No. 2, pp. 299–305, 2002.
- [17] R.E. Precup, S. Preitl, "PI and PID controllers tuning for integral-type servo systems to ensure robust stability and controller robustness", *Electrical Eng.*, Vol. 88, No. 2, pp. 149–156, 2006.
- [18] S.E. Hamamcı and A Uçar "A robust model-based control for uncertain systems", *Transactions of the Institute of Measurement and Control.*, Vol. 24, No. 2, pp. 431–445, 2002.
- [19] I. Kaya, N. Tan, D.P. Atherton, "A refinement procedure for PID controllers", *Electrical Eng.*, Vol. 88, No. 3, pp. 215–222, 2005.
- [20] E. Yesil, M. Guzelkaya, I. Eksin, O.A. Tekin, "Set-point regulator with blending mechanism", *Instrumentation Science & Technology*, Vol. 36, No.1, pp.1–17, 2008.
- [21] D.E. Rivera, M. Morari, S. Skogestad, "Internal model control. 4. PID controller design", *Ind. Eng. Chem. Res.*, Vol. 25, pp. 252–265, 1986.
- [22] E. Yesil, M. Guzelkaya, I. Eksin, O.A. Tekin, "Cross-coupled ratio control structure", *Instrumentation Science & Technology*, Vol. 35, No. 5, pp.523–536, 2007.
- [23] J.G. Zeigler, N.B. Nichols, "Optimum settings for automatic controllers", *Trans. ASME*, Vol. 64, pp. 759–768, 1942.
- [24] G.H. Cohen, G.A. Coon, "Theoretical consideration of retarded control", *Trans. Amer. Soc. Mech. Eng.*, Vol. 75, pp. 827–834, 1953.

- [25] S. Skogestad, "Simple analytic rules for model reduction and PID controller tuning", *J. Process Control*, Vol. 13, No. 4, pp. 291–309, 2003.
- [26] M. Morari, E. Zafiriou, *Robust Process Control*; Prentice Hall: Upper Saddle River, NJ, 1989.
- [27] D.E. Rivera, M. Morari, S. Skogestad, "Internal model control for PID controller design", *Ind. Eng. Chem. Proc. Des. Dev.*, Vol. 25, pp. 252–265, 1986.
- [28] J. Arputha Vijaya Selvi, T.K. Radhakrishnan, S. Sundaram, "Model based IMC controller for process with dead time", *Instrumentation Science & Technology*, Vol. 34, pp. 463–474, 2006.
- [29] D.M. de la Pena, D.R. Ramirez, E.F. Camacho, T. Alamo, "Application of an explicit min-max MPC to a scaled laboratory process", *Control Eng. Practice*, Vol. 13, No. 12, pp. 1463–1471, 2005.
- [30] M.R. Matausek, G.S. Kvascev, "A unified step response procedure for autotuning of PI controller and Smith predictor for stable processes", *J. Process Control*, Vol. 13, No. 8, pp. 787–800, 2003.
- [31] R. Bandyopadhyay, U.K. Chakraborty, D. Patranabis, "Autotuning a PID controller: A fuzzy-genetic approach", *J. of Sys. Architecture*, Vol. 47, No. 7, pp. 663–673, 2001.
- [32] J.M. Dias, A. Dourado, "A self-organizing fuzzy controller with a fixed maximum number of rules and an adaptive similarity factor", *Fuzzy Sets Systems*, Vol. 103, No. 1, pp. 27–48, 1999.
- [33] C. Pereira, J. Henriques, A. Dourado, "Adaptive RBFNN versus conventional self-tuning: comparison of two parametric model approaches for non-linear control", *Control Eng. Practice*, Vol. 8, No. 1, pp. 3–12, 2000.
- [34] G.W. Ng, P.A. Cook, "Real-time control of systems with unknown and varying time-delays, using neural networks", *Eng. Appl. Artif. Intell.*, Vol. 11, No. 3, pp. 401–409, 1998.