

1-1-2010

## Hierarchical fuzzy controller applied to multi-input power system stabilizer

EBRAHIM RASOOLI ANARMARZI

MOHAMMAD REZA FEYZI

MEHRDAD TARAFDAR HAGH

Follow this and additional works at: <https://journals.tubitak.gov.tr/elektrik>



Part of the [Computer Engineering Commons](#), [Computer Sciences Commons](#), and the [Electrical and Computer Engineering Commons](#)

---

### Recommended Citation

ANARMARZI, EBRAHIM RASOOLI; FEYZI, MOHAMMAD REZA; and HAGH, MEHRDAD TARAFDAR (2010) "Hierarchical fuzzy controller applied to multi-input power system stabilizer," *Turkish Journal of Electrical Engineering and Computer Sciences*: Vol. 18: No. 4, Article 3. <https://doi.org/10.3906/elk-0908-148>  
Available at: <https://journals.tubitak.gov.tr/elektrik/vol18/iss4/3>

This Article is brought to you for free and open access by TÜBİTAK Academic Journals. It has been accepted for inclusion in Turkish Journal of Electrical Engineering and Computer Sciences by an authorized editor of TÜBİTAK Academic Journals. For more information, please contact [academic.publications@tubitak.gov.tr](mailto:academic.publications@tubitak.gov.tr).

# Hierarchical fuzzy controller applied to multi-input power system stabilizer

Ebrahim Rasooli ANARMARZI, Mohammad Reza FEYZI,  
Mehrdad Tarafdar HAGH\*

Faculty of Electrical and Computer Engineering, University of Tabriz, Tabriz-IRAN  
e-mail: ebrahim.rasouly@gmail.com; feyzi@tabrizu.ac.ir; \*tarafdar@tabrizu.ac.ir

## Abstract

*This paper proposes the application of a hierarchical fuzzy system (HFS) based on multi-input power system stabilizer (MPSS) in multi-machine environment.*

*The number of rules increases exponentially with the number of variables in a standard fuzzy system. This problem is solved in the proposed HFS method. In this method, the total number of rules increases only linearly with the number of input variables. HFS consists of a number of low-dimensional fuzzy systems in a hierarchical form. In the MPSS, the deviation of reactive power  $\Delta Q$  is added to a  $\Delta P + \Delta \omega$  input type Power System Stabilizer (PSS) to have better performance. The performances of MPSS and the proposed method in damping inter-area mode of oscillation are observed in response to disturbances. It is found that the proposed PSS is performing satisfactorily within the whole range of disturbances. This comparative study is demonstrated through digital simulations.*

**Key Words:** Power system stabilizer (PSS), hierarchical fuzzy system (HFS), inter-area oscillation, fuzzy logic controllers, damping

## 1. Introduction

An electric power system contains thousands of interconnected electric elements. Many elements are highly nonlinear where some are combinations of electrical and mechanical parts. Power systems have thus developed into complex operating and control systems with various kinds of unstable characteristics. Since these systems are spread over wide geographical areas, some of which span over the entire continents, they are subject to many different types of disturbances [1].

Power system stabilizers (PSS's) as supplementary controllers are used to damp the electromechanical oscillations of the generators in power systems [2]. PSSs employ the lead-lag compensation with fixed parameters determined for a set of operating conditions, so they may not be as effective for different operating conditions and/or network configurations [3].

Nowadays, progresses in digital technology have made it possible to develop and implement new controllers based on modern and more sophisticated synthesis techniques such as: robust optimal control, adaptive control and/or artificial intelligence. Among these, fuzzy logic based controllers are particularly more attractive since they do not require any mathematical model of the system to be controlled. Some literatures used speed deviation ( $\Delta\omega$ ) and accelerating power deviation ( $\Delta P$ ) as the input signals of PSS. In Multi-input PSS (MPSS), the deviation of reactive power ( $\Delta Q$ ) is added to  $\Delta P + \Delta\omega$  input type PSS for a long distance power system [4–5].

At present, one of the important issues in fuzzy logic systems is how to reduce the total number of involved rules and their corresponding computation requirements. In a standard fuzzy systems, the number of rules increases exponentially with the number of variable increases. Suppose that there are  $n$  input variables and  $m$  membership functions for each variable, then the fuzzy system needs  $m^n$  rules. In fact, the complexity of problem increases exponentially with the number of variables involved. Hence, to deal with the rule-explosion problem, the idea of hierarchical fuzzy systems (HFS's) was reported [6–9]. In previous work by the authors the performances of standard Fuzzy Multi-input Power System Stabilizer (FMPSS) and MPSS under similar transient conditions were studied [10]. In this paper, the hierarchical fuzzy Multi-Input PSS (HFMPSS) is used to improve the damping of low frequency oscillations and enhance the stability of the system. The effectiveness of the proposed method is then demonstrated through digital computer simulation. Also, its performance is compared with a MPSS. It is shown that, by application of proposed method, good dynamic performance can be obtained.

## 2. Multi-input PSS

To analyze the effectiveness of using reactive power deviation ( $\Delta Q$ ) as input, consider a machine that is connected to infinite bus system as shown in Figure 1.

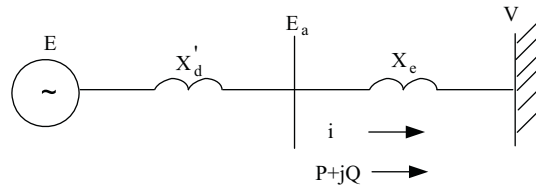

**Figure 1.** Model of machine connection to the infinite bus system.

In this figure,  $X'_d$  is direct axis transient reactance of the machine; and  $V$ ,  $E$  and  $E_a$  are system voltage, generator voltage and generator bus voltage, respectively. The generator active power  $P$  and reactive power  $Q$  are derived as follows due to change in  $\delta$ :

$$P = \frac{EV \sin \delta}{X'_d + X_e} \tag{1}$$

$$Q = \frac{E(E - V \cos \delta)}{(X'_d + X_e)}. \tag{2}$$

These equations are linearized about the operation point  $\delta = \delta_0$  as follows:

$$\Delta P = \frac{\partial P}{\partial \delta} \cdot \Delta \delta = \frac{EV}{X'_d + X_e} \cos \delta_0 (\Delta \delta) \tag{3}$$

$$\Delta Q = \frac{\partial Q}{\partial \delta} \cdot \Delta \delta = \frac{EV}{X'_d + X_e} \sin \delta_0 (\Delta \delta) \tag{4}$$

Curves of  $\frac{\Delta P}{\Delta \delta}$  and  $\frac{\Delta Q}{\Delta \delta}$  are shown in Figure 2.

Comparison of  $\frac{\Delta P}{\Delta \delta}$  and  $\frac{\Delta Q}{\Delta \delta}$  in this figure shows that, for  $\delta$  is greater than 45 degrees, absolute value of  $\frac{\Delta P}{\Delta \delta}$  is smaller than  $\frac{\Delta Q}{\Delta \delta}$ . So, it seems in the case  $\delta > 45^\circ$ , we can use the  $\frac{\Delta Q}{\Delta \delta} \gg \frac{\Delta P}{\Delta \delta}$  to improve the PSS.

### 3. Configuration of the MPSS

In the MPSS, the deviation of reactive power ( $\Delta Q$ ) is added to  $\Delta P + \Delta \omega$  input type PSS. Configuration of the MPSS is shown in Figure 3. Two lead-lag compensators are used for input signals, but determination of the values of the compensators is very difficult. Also, these compensators damp low frequency power oscillations less than the others. The optimization method of MPSS parameters is given in [4] and is used in this paper. The values of  $\Delta P$ sg $\Delta \omega$  gndg $\Delta Q$  are given in Table 5.

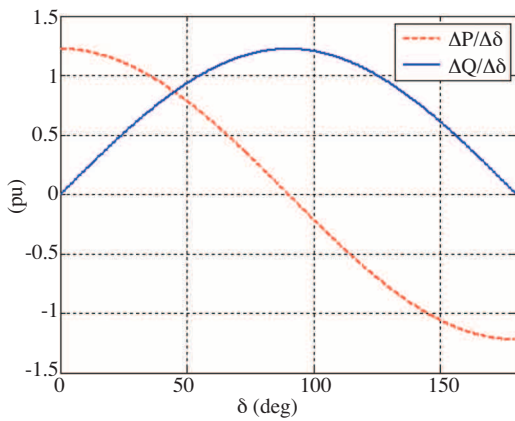

**Figure 2.** Variations of  $\frac{\Delta P}{\Delta \delta}$  and  $\frac{\Delta Q}{\Delta \delta}$  as functions of  $\delta$ .

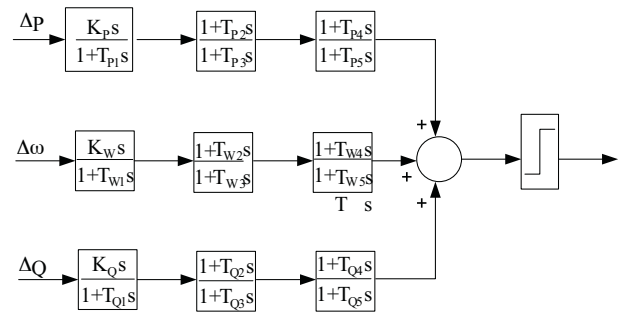

**Figure 3.** Configuration of the MPSS.

In this paper, Hierarchical Fuzzy Multi-input Power System Stabilizer (HFMPSS) is used instead of the lead-lag compensators.

### 4. Hierarchical fuzzy logic controller

Fuzzy control systems are rule-based systems in which a set of fuzzy rules presents a control decision mechanism to adjust the effects of certain system disturbances [11]. The knowledge-base module contains knowledge about all the input and output fuzzy partitions [12]. The aim of fuzzy control systems is to replace a skilled human operator with a fuzzy rule based system. The fuzzy logic controller provides an algorithm to convert the linguistic control scheme (which is based on expert knowledge) into an automatic control scheme.

In the hierarchical structure, the number of rules will increase linearly whereas it is exponential in conventional counterpart. In hierarchical fuzzy systems the number of rules is altered by decomposing the fuzzy system to a set of simpler fuzzy subsystem connected in a hierarchical manner [13] as shown in Figure 4.

In a hierarchical fuzzy logic controller (HFLC) structure the most influential parameters are chosen as the system variables in the first level, the next most important parameters are chosen as the system variables in the second level, and so on [14].

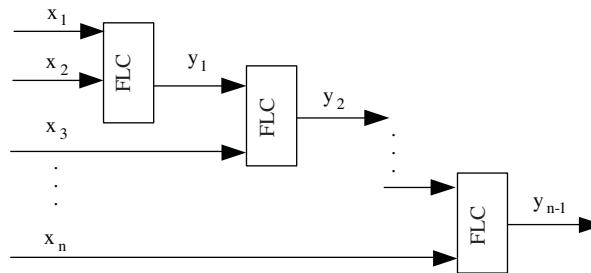

**Figure 4.** Hierarchical FLC structural representation.

In this hierarchy, the first level gives an approximate output which is then modified by the second level rule set. This procedure can be repeated in succeeding levels of hierarchy. The number of rules in a complete rule set is reduced towards a linear function of the number of variables by the hierarchy [15]. However, in the hierarchical structure, each input variable is used in a two-input FLC and the knowledge can be easily redesigned when adding or removing an input variable.

## 5. Hierarchical fuzzy logic multi-input power system stabilizer

Three input variables ( $\Delta P + \Delta \omega + \Delta Q$ ) are used as inputs of the HFMPSS. A fuzzy set with seven elements is used for both the input and output membership functions. These are PB (Positive Big), PM (Positive Medium), PS (Positive Small), ZE (Zero), NS (Negative Small), NM (Negative Medium) and NB (Negative Big).

In this paper, hierarchical control structure is constructed by two fuzzy subsystems where each subsystem has only two inputs. The  $\Delta Q$  and  $\Delta \omega$  are the input variables of the first subsystem. The output of the first subsystem and the variable  $\Delta P$  are the input variables of second subsystem as shown in Figure 5.

The triangular membership functions are used to define the degree of membership as shown in Figure 6. The centroid defuzzification rule is applied to evaluate the output signal. The adopted fuzzy rules are listed in Tables 1 and 2. The triangular membership functions are normalized using the following factors:

$K_W = 33.33$ , is the Speed change input coefficient;

$K_Q = 0.058$ , is the Reactive power change input coefficient;

$K_P = 0.5$ , is the Active power change input coefficient;

$K_{U1} = 1$ , is the Output coefficient (in subsystem 1); and

$K_{UPSS} = 1$ , is the Output coefficient (in subsystem 2).

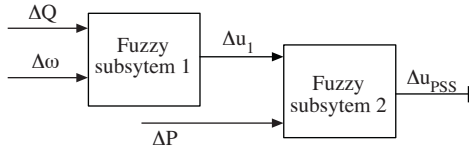

Figure 5. Detailed HFC structure.

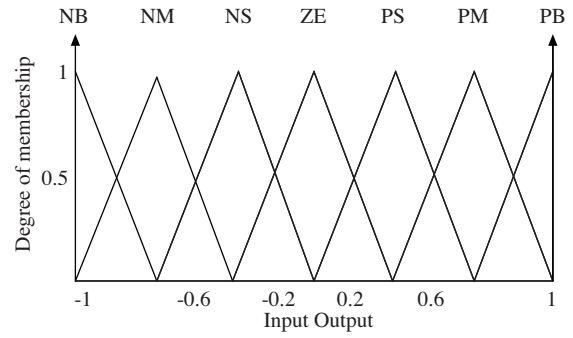

Figure 6. Membership function scaled from -1 to 1.

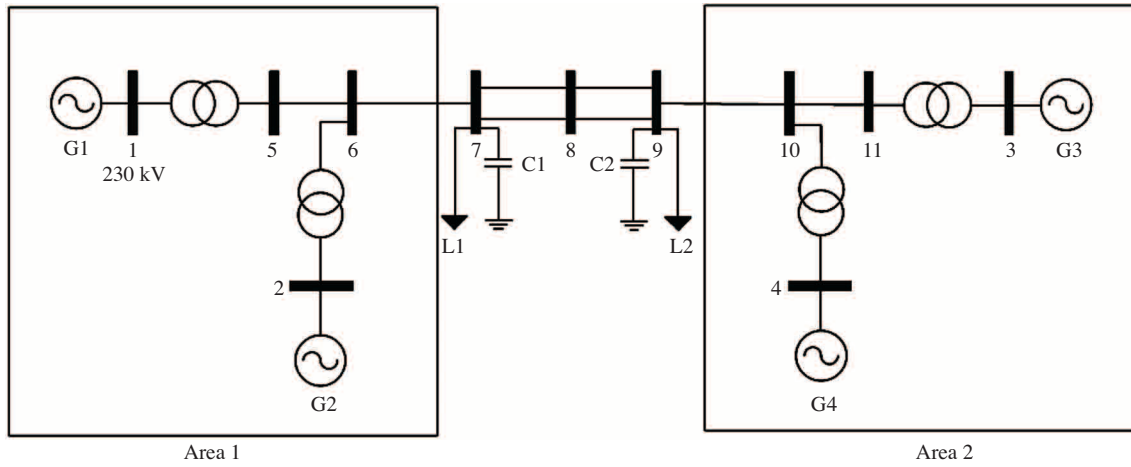

Figure 7. Kundur's two-area test system.

Table 1. Rules table.

$\Delta\omega$ \ $\Delta Q$	NB	NM	NS	ZE	PS	PM	PB
NB	NB	NB	NB	NB	NM	PS	ZE
NM	NB	NM	NM	NM	NS	ZE	PS
NS	NB	NM	NS	NS	ZE	PS	PM
ZE	NB	NM	NS	ZE	PS	PM	PB
PS	NM	NS	ZE	PS	PS	PM	PB
PM	NS	ZE	PS	PM	PM	PB	PB
PB	ZE	PS	PM	PB	PB	PB	PB

## 6. System model

### 6.1. Power system model

The test system, as shown in Figure 7, is a typical two-area network and is given in [16]. The parameters of generator, capacitors, etc are listed in appendix A. Two areas are linked by two 230 kV lines and each area has two generators.

**Table 2.** Rules table.

$\Delta\omega$	$\Delta Q$	NB	NM	NS	ZE	PS	PM	PB
NB	NB	NB	NB	NB	NM	NM	NS	ZE
NM	NB	NB	NM	NM	NM	NS	ZE	PS
NS	NB	NB	NM	NS	NS	ZE	PS	PM
ZE	NM	NM	NS	ZE	ZE	PS	PM	PM
PS	NM	NS	ZE	PS	PS	PS	PM	PB
PM	NS	ZE	PS	PM	PM	PM	PM	PB
PB	ZE	PS	PM	PB	PB	PB	PB	PB

### 6.2. AVR and PSS

The excitation system is a dc exciter similar to that of [17] without the saturation function. The basic elements that form the excitation system block are the voltage regulator and the exciter.

The conventional power system stabilizer (CPSS) is modeled by the nonlinear system as shown in Figure 8. The optimization procedure of this CPSS is same as that of [16]. The values of  $\Delta\omega$  are given in Table 5.

### 6.3. Results

The time domain simulations were performed to evaluate the performance of the system under the small and large disturbances. The results are described as follows:

### 6.4. Small disturbance

A 5% magnitude pulse is applied at the voltage reference of machine1 with both parallel transmission lines connected. The simulation results for rotor angle, terminal voltage and transmitted active power from area 1 to area 2 are shown in Figure 9 to Figure 11, respectively. Additional simulation results are presented in Figure 12 to Figure 14.

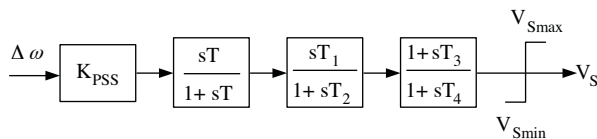

**Figure 8.** Block diagram of the PSS.

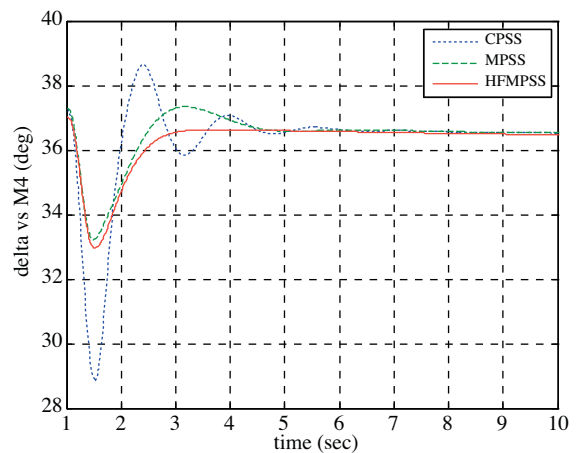

**Figure 9.** Rotor angle deviation of machine 1 with respect to machine 4.

These figures show the superiority of HFMPSS over its conventional counterpart. It can be seen from Figures 9–14 that HFMPSS have a shorter settling time and smaller overshoot compared to CPSS and MPSS. Obviously, the comparison of CPSS with the improved methods is not the main goal of this work. However, it is also shown in the figures for the sake of further information. Comparison of Figures 9–11 with [18] results show that the proposed method in [18] and HFMPSS have almost the same overshoot and settling time, where HFMPSS demonstrate slightly better performance regarding the undershoot.

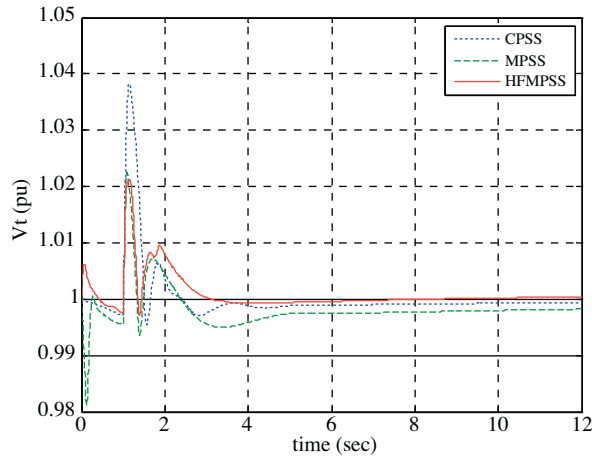

Figure 10. Terminal voltage of machine 1.

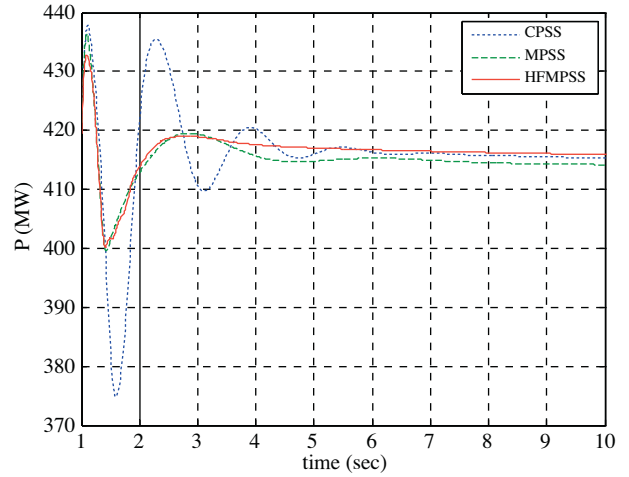

Figure 11. Active power from area 1 to area 2.

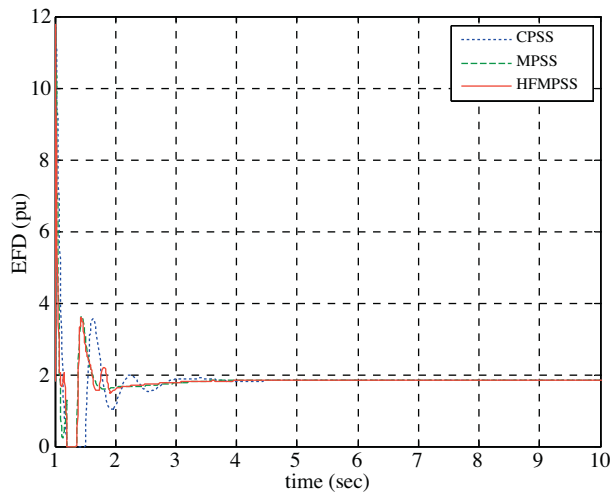

Figure 12. Excitation voltage of machine 1.

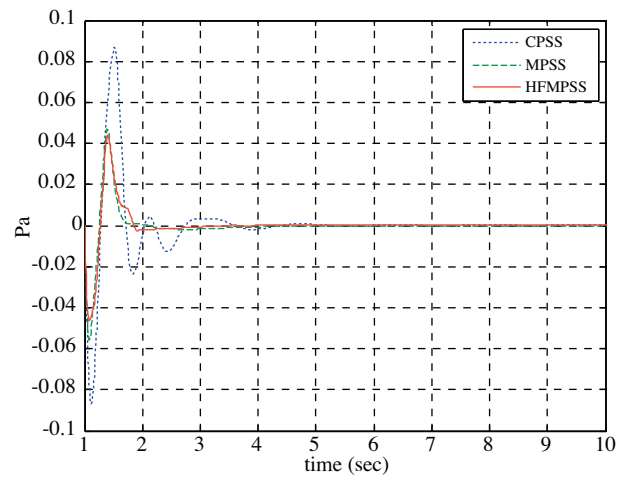

Figure 13. Power deviation of machine 1.



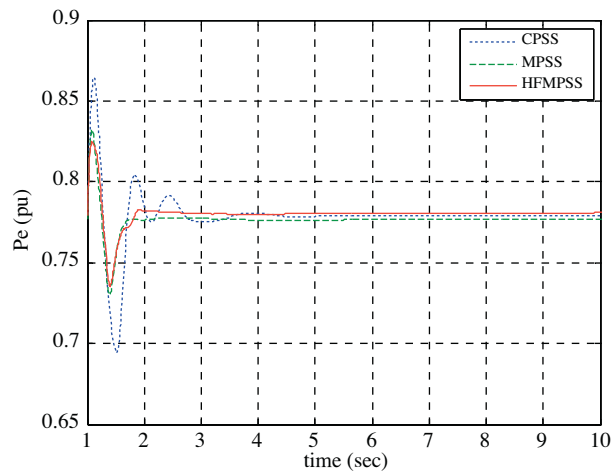

Figure 14. Output power of machine 1.

### 6.5. Large disturbance

A three-phase to ground fault at the middle of one of the two parallel tie lines, as a representative of large disturbance, is also simulated. The performances of CPSS and MPSS and HFMPSS under these transient conditions are shown in Figures 15–20. As seen, the HFMPSS shows better control performance compared to those of CPSS and MPSS in terms of settling times and damping effects.

At the same time, while the performance of the proposed method in [18] suffers from a larger overshoot of over 60% with a long 7-second settling time, the proposed HFMPSS shows a 12.5% of overshoot that settles within less than 5 seconds.

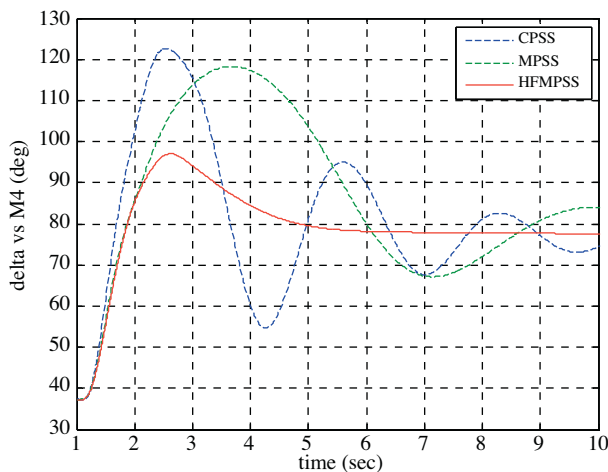

Figure 15. Rotor angle deviation of machine 1 with respect to machine 4.

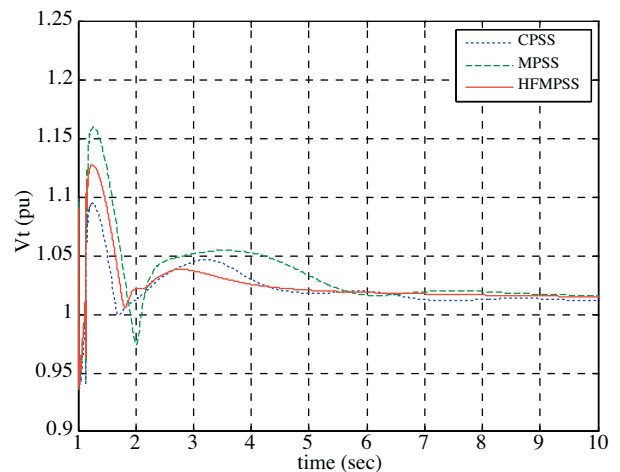

Figure 16. Terminal voltage of machine 1.

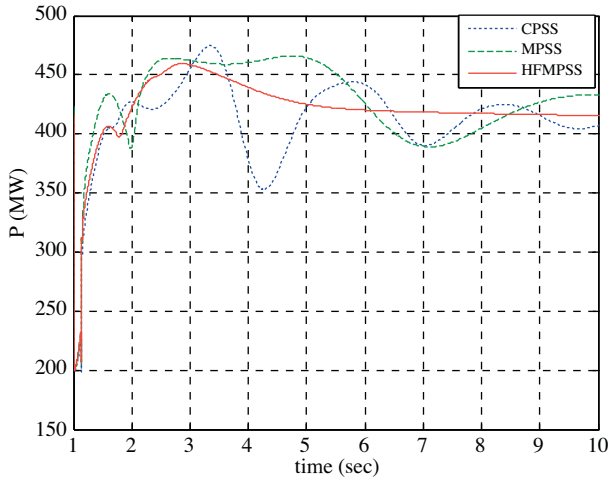

Figure 17. Active power from area 1 to area 2.

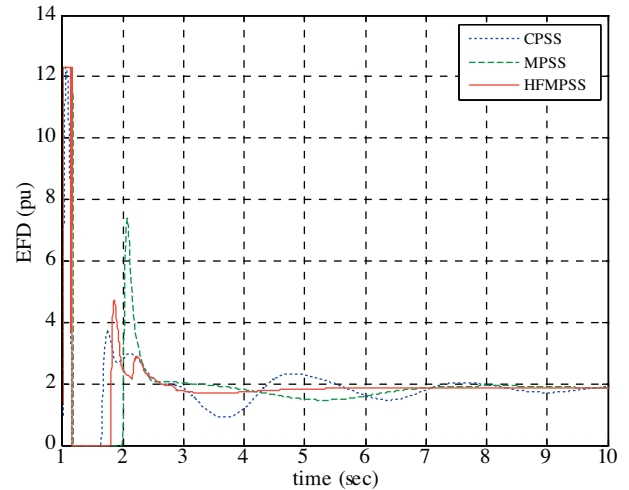

Figure 18. Excitation voltage of machine 1.

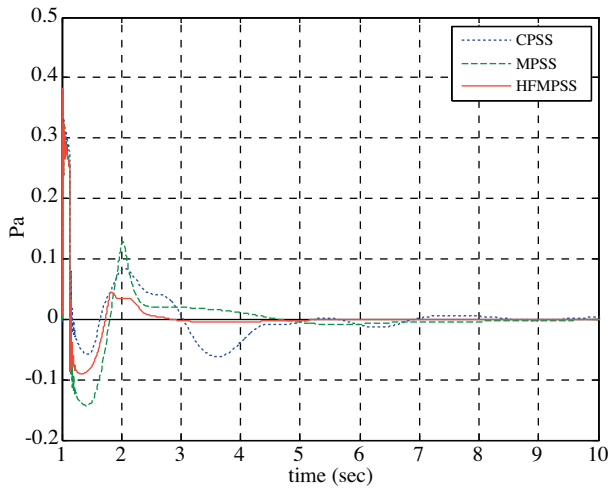

Figure 19. Power deviation of machine 1.

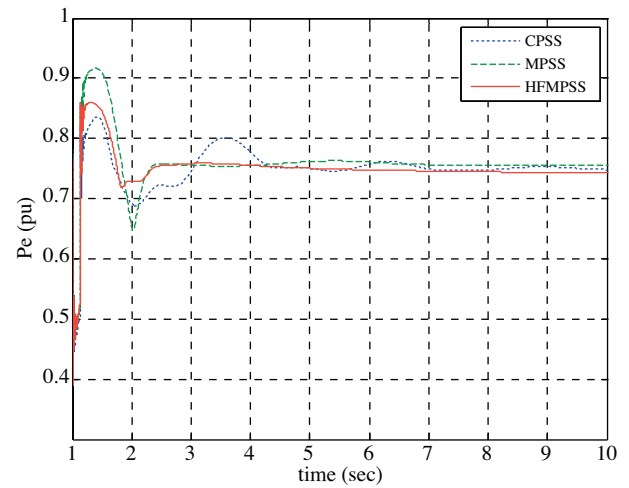

Figure 20. Output power of machine 1.

## 7. Conclusion

In this paper, a hierarchical fuzzy system based on multi-input power system stabilizer (HFMPSS) design is investigated for test system is given in [16]. In the MPSS, the deviation of reactive power ( $\Delta Q$ ) is added to  $\Delta P + \Delta \omega$  input type PSS for a long distance power system where  $\delta$  is large. In the hierarchical structure, the number of rules will increase linearly whereas it is exponential in conventional counterpart. Simulation results show that the HFMPSS has good performance to damp low frequency power oscillations with respect to the CPSS and MPSS and the proposed method in [18], which proves the effectiveness of the proposed fuzzy control strategy in multi-input power system stability. According to the simulation results the HFMPSS has good robustness without changing any parameters.

## References

- [1] P. M. Anderson, A. A. Fouad, "Power system control and stability", Iowa State University Press, Ames, Iowa, 1977.
- [2] M. Gonzalez, O. P. Malik, "Power system stabilizer design using an online adaptive neurofuzzy controller with adaptive input link weights", IEEE Trans. Energy Convers. Vol. 23, No. 3, pp. 914-922, Sep. 2008.
- [3] D. E. Kvasov, D. Menniti, A. Pinnarelli, Y. D. Sergeyev, N. Sorrentino, "Tuning fuzzy power-system stabilizers in multi-machine systems by global optimization algorithms based on efficient domain partitions", Elsevier, Electric Power Systems Research, . Vol. 78, pp. 1217-1229, Jan. 2008.
- [4] Y. Kitauchi, H. Taniguchi, T. Shirasaki, Y. Ichikawa, M. Amano , M. Banjo, "Experimental verification of multi-input PSS with reactive power input for damping low frequency power swing", IEEE Trans. Energy Convers. Vol. 14, No. 4, pp. 1124-1130, Dec 1999.
- [5] M. Ozaki, M. Mizutani, "A design method of multi-input PSS using high speed genetic algorithm ", IEEE. Power System Technology, Vol. 3, pp. 1287-1291, 2000.
- [6] H. Kikuchi, A. Otake, S. Nakanishi, "Functional completeness of hierarchical fuzzy modeling", Information Science, Vol. 110, No. 1-2, pp. 51-60. Sept. 1998.
- [7] M. Lee, H. Chung, F. Yu, "Modeling of hierarchical fuzzy systems", Elsevier, Fuzzy Sets and Systems, Vol. 138, pp. 343-361, 2003.
- [8] R. Hammell, T. Sudkamp, "Adaptivity in a hierarchical fuzzy model", IEEE. Annual Conference of the North American Fuzzy Information Processing Society, pp. 151-156, 1995.
- [9] C. France, L. Richard, "Designing a hierarchical fuzzy logic controller using the differential evolution approach", Elsevier, Applied Soft Computing, Vol. 7, pp. 481-491, 2007.
- [10] E. Rasooli Anarmarzi, M. Reza Feyzi, M Tarafdar Hagh, " Improvement of Multi-Input Power System Stabilizer With Fuzzy", 23<sup>rd</sup> Intl. Power System Conf., PSC2008, Iran, Tehran, paper No. 98-F-PSS-0235, in Farsi.
- [11] H. A. Toliyat, J. Sadeh, R. Ghazi, "Design of augmented fuzzy logic power system stabilizers to enhance power systems stability", IEEE Trans. Energy Convers. Vol. 11, pp. 97-103, March 1996.
- [12] T. Ross, "Fuzzy logic with engineering applications", McGraw-Hill International Editions, Electrical Engineering Series, 1997.
- [13] G. Raju, J. Zhou, R. Kisner, "Hierarchical fuzzy control", International Journal of Control, vol. 54, pp. 1201-1216, Nov. 1991.
- [14] L. Wang, " Analysis and design of hierarchical fuzzy systems", IEEE Trans. Fuzzy System, Vol. 7, pp. 617-624, Oct. 1999.
- [15] H. Li, S. Tso, "Higher order fuzzy control structure for higher order or time-delay systems", IEEE Trans. Fuzzy System, Vol. 7, pp. 540-552, Oct. 1999.
- [16] P. Kundur, "Power system stability and control", McGraw-Hill, New York, 1994.
- [17] Recommended practice for excitation system models for power system stability studies, IEEE standard 421.5-1992; August, 1992.

- [18] P. Mitra, S. Chowdhury, S. P. Chowdhury, S. K. Pal, R. N. Lahiri, Y. H. Song, "Performance of A Fuzzy Power System Stabilizer With Tie Line Active Power Deviation Feedback", IEEE PSCE, pp. 884-889, Oct. 2006.

## Appendix

**Table 3.** Generator data.

No. of Gen Param.	G1,G2	G3,G4
Type	Steam	Steam
Capacity (MVA)	900	900
Voltage (kV)	20	20
$X_d$ (pu)	1.8	1.8
$X'_d$ (pu)	0.3	0.3
$X''_d$ (pu)	0.25	0.25
$X_q$ (pu)	1.7	1.7
$X'_q$ (pu)	0.55	0.55
$X''_q$ (pu)	0.25	0.25
H (sec)	6.5	6.175
$T'_{d0}$ (sec)	8	8
$T''_{d0}$ (sec)	0.03	0.03
$T'_{q0}$ (sec)	0.4	0.4
$T''_{q0}$ (sec)	0.05	0.05

**Table 4.** Load data.

Param. No. of Bus	$P_1$ (MW)	$Q_1$ (Mvar)	$Q_c$ (Mvar)
7	967	100	387
9	1767	100	537

**Table 5.** Load data.

Input Parameter	$\Delta\omega$	$\Delta P$	$\Delta Q$
$K_{PSS}$	20	0.5	0.01
T (sec)	10	1	1
$T_1$ (sec)	3	0.06	0.06
$T_2$ (sec)	5.4	1	1
$T_3$ (sec)	3	0	0
$T_4$ (sec)	5.4	0	0

Transmission lines data:

$$V_{base} = 230 \text{ kV}, S_{base} = 100 \text{ MVA}$$

$$R = 0.0001 \text{ pu/km}, X = 0.001 \text{ pu/km}, B_C = 0.00175 \text{ pu/km}$$

AVR Data:

$$K_A = 200, T_A = 0.001 \text{ sec}$$