

1-1-2011

## Neuro-fuzzy soft-switching hybrid filter for impulsive noisy environments

ŞABAN ÖZER

HASAN ZORLU

Follow this and additional works at: <https://journals.tubitak.gov.tr/elektrik>



Part of the [Computer Engineering Commons](#), [Computer Sciences Commons](#), and the [Electrical and Computer Engineering Commons](#)

---

### Recommended Citation

ÖZER, ŞABAN and ZORLU, HASAN (2011) "Neuro-fuzzy soft-switching hybrid filter for impulsive noisy environments," *Turkish Journal of Electrical Engineering and Computer Sciences*: Vol. 19: No. 1, Article 6. <https://doi.org/10.3906/elk-1002-407>

Available at: <https://journals.tubitak.gov.tr/elektrik/vol19/iss1/6>

This Article is brought to you for free and open access by TÜBİTAK Academic Journals. It has been accepted for inclusion in Turkish Journal of Electrical Engineering and Computer Sciences by an authorized editor of TÜBİTAK Academic Journals. For more information, please contact [academic.publications@tubitak.gov.tr](mailto:academic.publications@tubitak.gov.tr).

# Neuro-fuzzy soft-switching hybrid filter for impulsive noisy environments

Şaban ÖZER, Hasan ZORLU

*Department of Electrical-Electronic Engineering, Erciyes University, Kayseri, TURKEY  
e-mail: hzorlu@erciyes.edu.tr*

## Abstract

*In this study, a new soft-switching hybrid filter based on a neuro-fuzzy network for impulsive noisy environments is proposed. The hybrid filter was built by combining an adaptive finite impulse response (FIR) filter, an adaptive weighted myriad (WMy) filter, and a soft-switching mechanism based on a neuro-fuzzy (NF) network. Performance of the hybrid filter was tested in  $\alpha$ -stable noisy situations and compared with adaptive FIR, WMy, and weighted median (WMd) filter performances. According to the simulation results; the proposed hybrid filter has better performance than the adaptive FIR, WMy, and WMd filters, and has the ability of effectively suppressing the impulsive noisy environments.*

**Key Words:**  $\alpha$ -stable noise, nonlinear filtering, myriad filter, hybrid filter

## 1. Introduction

The traditional approach in statistical signal processing problems to obtain the best solution is the generation of a specific signal and noise model relating to the problem studied. The best solution is obtained using this approach; small deviations are ignored. Gaussian models are often used for the statistical characteristics modeling of classical statistical signal processing theory. The Gaussian model is valid for some real-world transactions; however, non-Gaussian situations are occurring in real life. For example, a large part of the physical phenomena in nature is of an impulsive structure and can be modeled more precisely by non-Gaussian distributions. Impulsive signals and noises are characterized in sharp, pointed, or sporadic forms in data series. As some examples of impulsive operations, atmospheric noise radio links, ocean acoustic noise, and switching transients in telephone channels have been given [1, 2].

Linear filters have been used as an important tool for noise filtering in signal processing. In many cases, linear filters have perfect performance and are easy to design. In addition, if the system is linear and Gaussian, linear filters are optimal in the sense of least squares in the form of all filtering operations [3-5]. However, linear filter applications are limited to real systems. Moreover, the small deviations from systems sometimes make their performance severely retrogress. For instance, the properties of a little non-Gaussian noise and a little

nonlinearity of the system make the filter's performance very poor. In order to overcome these disadvantages, many nonlinear filters have been offered in the literature, such as median filters, midrange filters, myriad filters, and other filters [6, 7]. Recently, some of those nonlinear filters have been studied, proposed, and applied to various filtering problems in practice. Various hybrid filters have especially been proposed in signal and image processing areas [8-13].

In recent years, as a complete model of the impulse noise process, signal processing studies based on  $\alpha$ -stable distribution have been increasing significantly [14, 15].  $\alpha$ -stable noise is connected to changes in the shape of  $0 < \alpha \leq 2$ . When  $\alpha = 1$ , the noises are of the Cauchy distribution; when  $\alpha = 2$ , the noises are of the Gaussian distribution. The  $\alpha$ -stable noise has a characteristic function of  $\Phi(\omega) = e^{-\gamma|\omega|^\alpha}$ . In this function,  $\gamma$  is the dispersion parameter and  $\alpha$  is the characteristic variable. The use of the  $\alpha$ -stable distribution as a statistical model is theoretically verified by 2 features [14]. The first is the stability feature: the sum of 2 independent stable random variables with the same characteristic coefficient is also stable with the same characteristic. The second is the generalized central limit theorem: if the sum of an unlimited number of independent and similarly distributed random variables (with finite or infinite variance) converges in distribution, the limiting distribution is  $\alpha$ -stable. Thus,  $\alpha$ -stable random variables can appear in the real world as the effects of a large number of independent contributing factors in the same way that Gaussian random variables do [15]. Recently, myriad filters have been used as robust nonlinear filters for impulse noise environments (especially with  $\alpha$ -stable noise) [15]. This filtering has been successfully applied to communications, signal, and image processing [15-18].

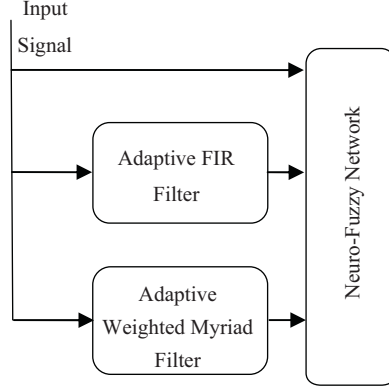
In the last few years, there has been an increasing research interest in the applications of soft computing techniques, such as neural networks and fuzzy systems, to the problems in many areas [19, 20]. Learning and generalization abilities, provision of plausible solutions to nonlinear problems, fast real-time operations, and ease of implementation have made artificial neural networks popular, as well [19]. Fuzzy inference systems (FIS) [20] are nonlinear systems capable of inferring complex nonlinear relationships between input and output variables. Neuro-fuzzy (NF) systems offer the capability of neural networks to learn from examples and the capability of fuzzy systems to model the uncertainty encountered in noisy environments [12, 13].

In this study, a new soft-switching hybrid filter based on a neuro-fuzzy network for removing  $\alpha$ -stable impulsive noise from digital signals is proposed. The hybrid filter consists of an adaptive finite impulse response (FIR) filter, an adaptive weighted myriad (WMy) filter, and a soft-switching mechanism based on a neuro-fuzzy network. In order to improve the performance of filtering in an impulsive noisy environment, adaptive FIR and WMy filters were combined with a neuro-fuzzy network. Performance of the proposed hybrid filter was tested at different  $\alpha$  parameters of the noise signal and also compared with adaptive FIR, WMy, and WMd filter performances. Experimental results showed that the proposed hybrid filter has better performance than the adaptive FIR, WMy, and WMd filters, and it also has the suppressing efficiency capability for  $\alpha$ -stable noisy situations.

The organization of this paper is as follows. In section 2, the structure of the proposed hybrid filter and its building blocks are explained. In section 3, simulations are made to verify the feasibility of the proposed method. Finally, some conclusions are offered in section 4.

## 2. Proposed operator

The structure of the proposed hybrid filter is shown in Figure 1. The filter consists of an adaptive FIR filter, an adaptive WMy filter, and a neuro-fuzzy network. The neuro-fuzzy network uses the information from the adaptive FIR filter, the WMy filter, and the input signal to compute the system output.



**Figure 1.** Proposed hybrid filter.

### 2.1. FIR filter

FIR filters, as an example of linear filters, estimate the existing data point by taking a weighted sum of previous measurements in a window of finite or infinite length. The FIR filter can be expressed as [9, 21]

$$y_n = \sum_{i=1}^k b_i x_{n-i+1}, \quad (1)$$

where  $k$  and  $b_i$  stand for filter length and filter weighting coefficients, respectively.

### 2.2. Weighted myriad filter

Recently, myriad filters, as strong nonlinear filters, are being used for  $\alpha$ -stable environments [15]. This filter has been successfully applied to communications, signal, and image processing [15-18]. The myriad filter

$$\beta_K = \text{myriad}(K; x_1, x_2, \dots, x_N) = \arg \min \sum_{i=1}^N \log [K^2 + (x_i - \beta^2)] \quad (2)$$

has a cost function as defined in equation (2), where  $N$  is the filter length,  $x_i$  is the input data samples' data values, and  $K$  is the linearity factor. The WMy filter has been generalized by adding positive weight parameters into the input samples. The WMy filter

$$\beta_K = \text{myriad}(K; w_1 \circ x_1, w_2 \circ x_2, \dots, w_N \circ x_N) = \arg \min \sum_{i=1}^N \log [K^2 + w_i (x_i - \beta^2)] \quad (3)$$

has a cost function as defined in equation (3). The WMy filter is generally used as an adaptive structure [15-18]. Further details about WMy filters are available in [15-18].

### 2.3. Neuro-fuzzy network

Soft computing techniques are often used in solving different problems because of their ability to learn, make generalizations, tolerate noise, and apply to different problems easily [19]. In this approach, some difficulties have been encountered, as some artificial intelligence parameters that have been chosen to be corrected depend on systems and the carrying out of a variety of trial and error process. In both artificial neural networks and fuzzy logic techniques, basic logic is based on how the human brain works. These systems simulate the inference mechanism of the human brain. Both techniques can model complex and nonlinear systems with sufficient accuracy [19, 20] because the techniques do not require mathematical modeling of the controlled system.

Fuzzy logic control, using rules based on common sense, identifies and controls the systems. Fuzzy logic uses variables expressed in words that imitate human decision-making instead of mathematical variables. In traditional logic, the truth value of a variable can be ‘1’ or ‘0.’ However, in fuzzy logic, the value can take all values within the range of 0-1. This value is called the membership value. The curves that determine the membership value of an input are called membership functions. As the applied mathematics are simple, the abilities to model nonlinear systems, which are based on daily language, softly (not forming specified borders) and to tolerate uncertain information are among the most important advantages of systems based on fuzzy logic [20].

Artificial neural networks, based on the physiological structure of the brain, are designed and formed from a large number of simple processors (neurons) working in parallel with each other. The behavior of a neural network largely determines the connections between neurons; all of the information learned is reserved in these connections. Artificial neural networks can be trained to perform a certain function, and this training is provided by values of connection changing. The most important way in which artificial neural networks differ from traditional systems of learning are in their ability to generalize in a parallel operation. These features provide advantages such as speed, fault-tolerance, and efficiency [19].

Neuro-fuzzy systems represent the capability of neural networks to learn from examples and the extraction results capability of fuzzy systems allows them to model uncertainty. Readers interested in details of neuro-fuzzy systems are referred to [20].

## 3. Simulations

For simulations, the training and testing models of adaptive FIR, WMy, and WMd filters and the proposed hybrid filter are given in Figure 2. The noiseless input signal  $x(n)$  was chosen to be a chirp-type signal. Specifically, the signal is given as  $x(n) = \sin[w(n)]$ ,  $n = 0, 1, \dots, L-1$ , where the radian frequency is  $w(n) = (\pi/3)[L/(L-1)][n/L-1]^2$ , as shown in Figure 3. The desired signal  $d(n)$  was acquired by passing noiseless input signal  $x(n)$  through a low-pass FIR filter of window length  $N = 13$  and cutoff frequency  $w_c = \pi/50$ , as shown in Figure 4.

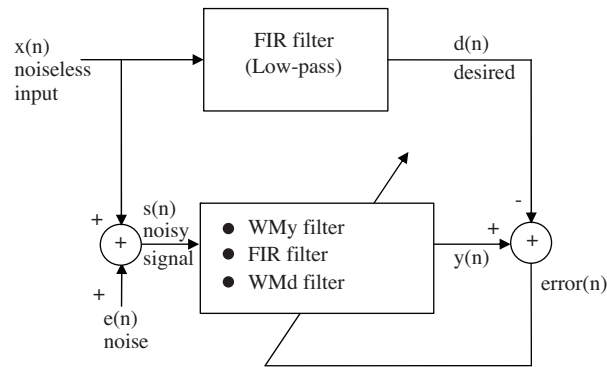


Figure 2a. Training and testing model of filters for adaptive optimization.

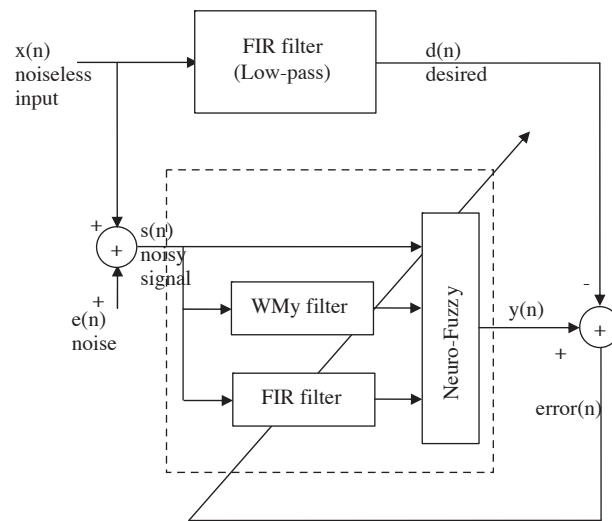


Figure 2b. Training and testing model of proposed hybrid filter for adaptive optimization.

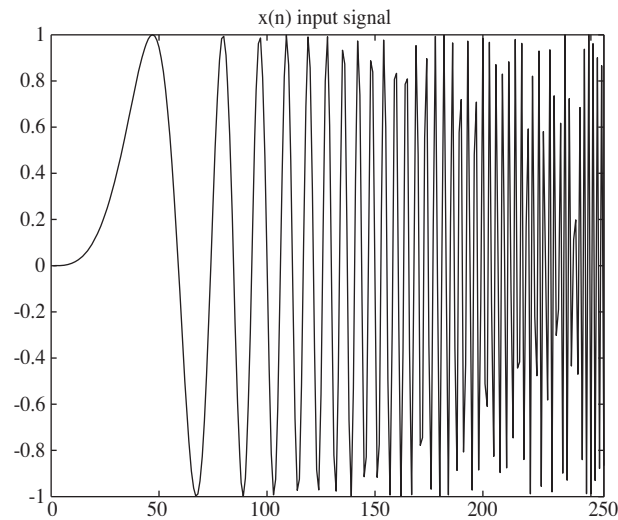
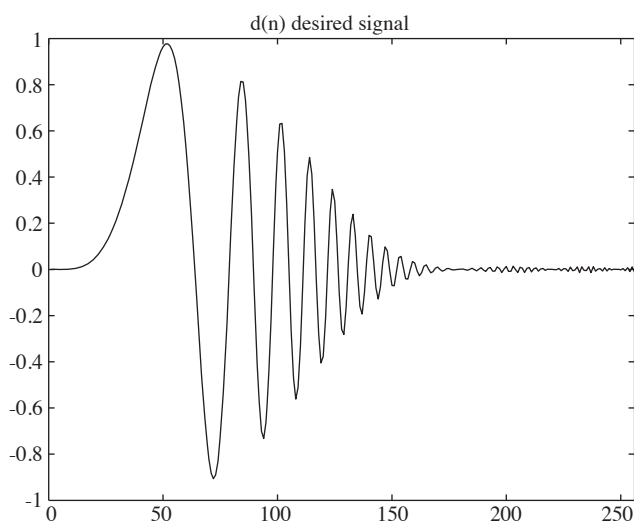


Figure 3. Noiseless chirp-type input signal  $x(n)$ .

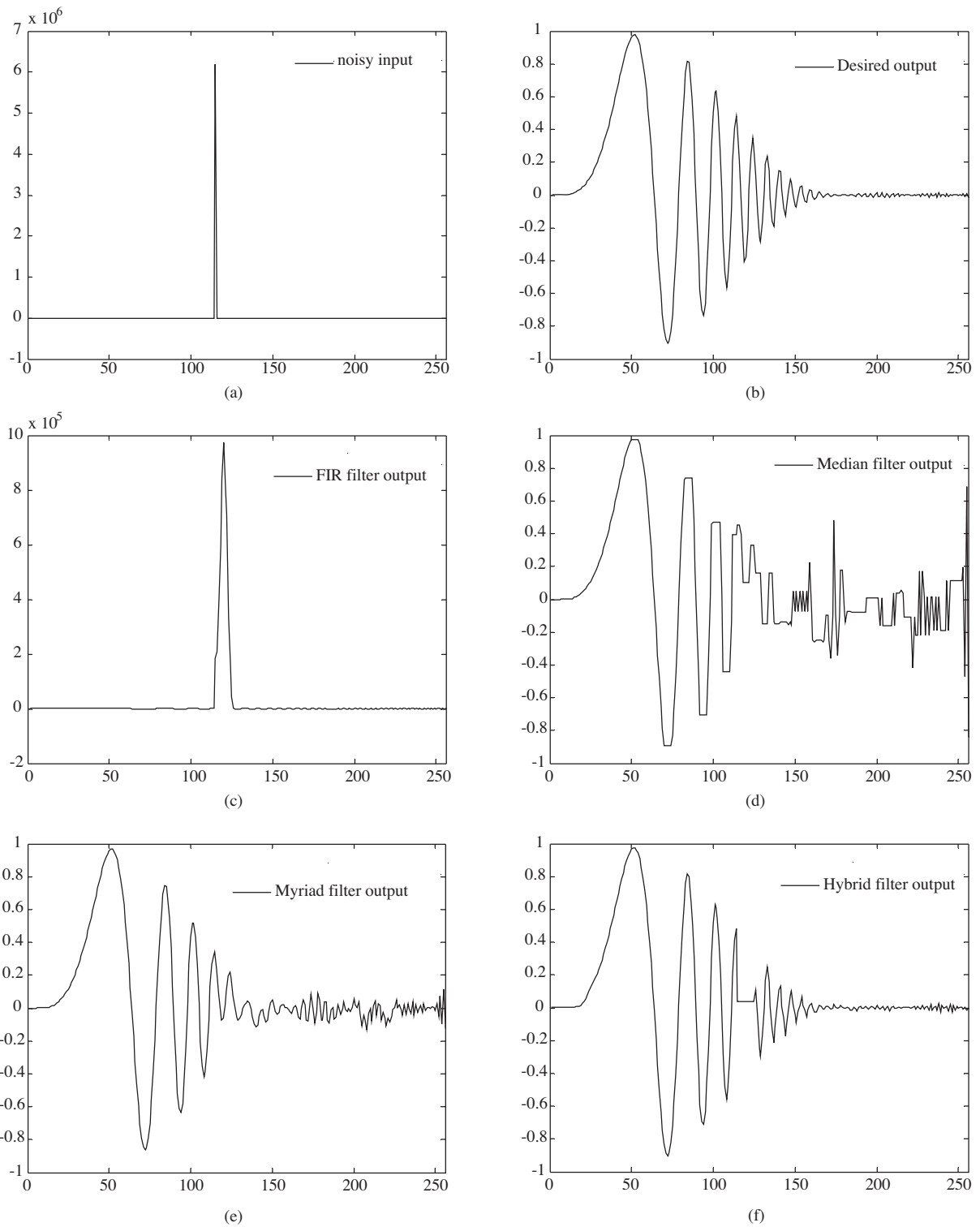


**Figure 4.** Desired signal  $d(n)$  (low-pass FIR filtering of  $x(n)$ ).

Figure 2a shows the block diagram representing the optimization of the adaptive FIR, WMy, and WMd filters. In these optimizations, the adaptation of the adaptive FIR filter utilized an adaptive least mean absolute deviation (LMAD) algorithm from [18]. For the adaptive WMy filter, the algorithm developed by Kalluri and Arce was used from [18]. For the adaptive WMd filter, an adaptive weighted order statistic (WOS) algorithm from [18] was used. Figure 2b shows the block diagram representing the optimization of the proposed hybrid filter. All of these mentioned filters were trained using the noiseless input signal  $x(n)$  and desired signal  $d(n)$ , each of length  $L = 256$ . As shown in Figure 2b, noiseless input signals and outputs of the adaptive FIR and WMy filters were fed into the input of the neuro-fuzzy network. The neuro-fuzzy network used in this study was a first-order Sugeno-type fuzzy system with 3 inputs and 1 output. Each input had 3 Gaussian membership functions, and the output had a linear membership function. The parameters of the neuro-fuzzy network were iteratively tuned by using the hybrid learning optimization algorithm, which combines the gradient method and the least squares estimate to identify [20].

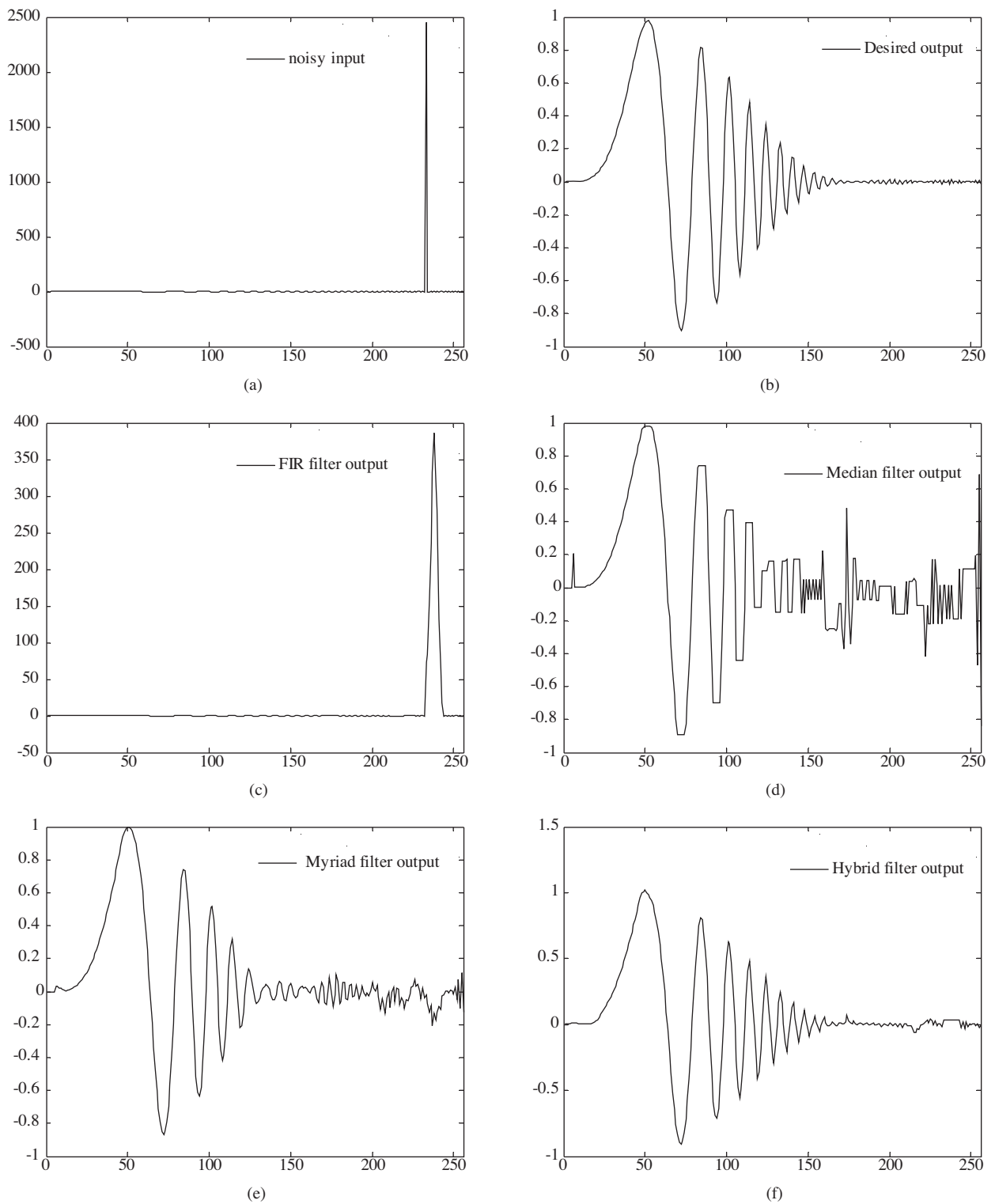
The performances of the trained filters were compared by applying them to noisy chirp-type test signals. These test signals, as shown in Figures 5a, 6a, 7a, 8a, and 9a, were obtained by adding different realizations of  $\alpha$ -stable noise to the characteristic exponent  $\alpha = 0.1, 0.4, 0.8, 1.3, 1.8$  and dispersion  $\gamma = 0.01$  to the noiseless signal of Figure 3. The different  $\alpha$  parameters of the  $\alpha$ -stable noisy environments were applied for these mentioned filters and the results are shown in Figures 5-9. In addition, the mean square errors (MSE) originating in filtering the test signals obtained by adding different  $\alpha$  parameters in the range of  $[0.1 \sim 2.0]$  are given in the Table.

The results show us that the adaptive WMd filter did not show good performance for removing impulsive noise. However, the adaptive FIR filter performance was better than the adaptive WMy filter where the noise characteristic was close to Gaussian distribution cases (especially  $\alpha > 1.5$ ). On the other hand, the adaptive WMy filter was found to be more successful than the adaptive FIR filter in other cases (especially  $\alpha < 1.0$ ). However, the proposed hybrid filter gave the best performance among all of these filters for all  $\alpha$  parameter values ( $0.1 < \alpha < 2.0$ ).

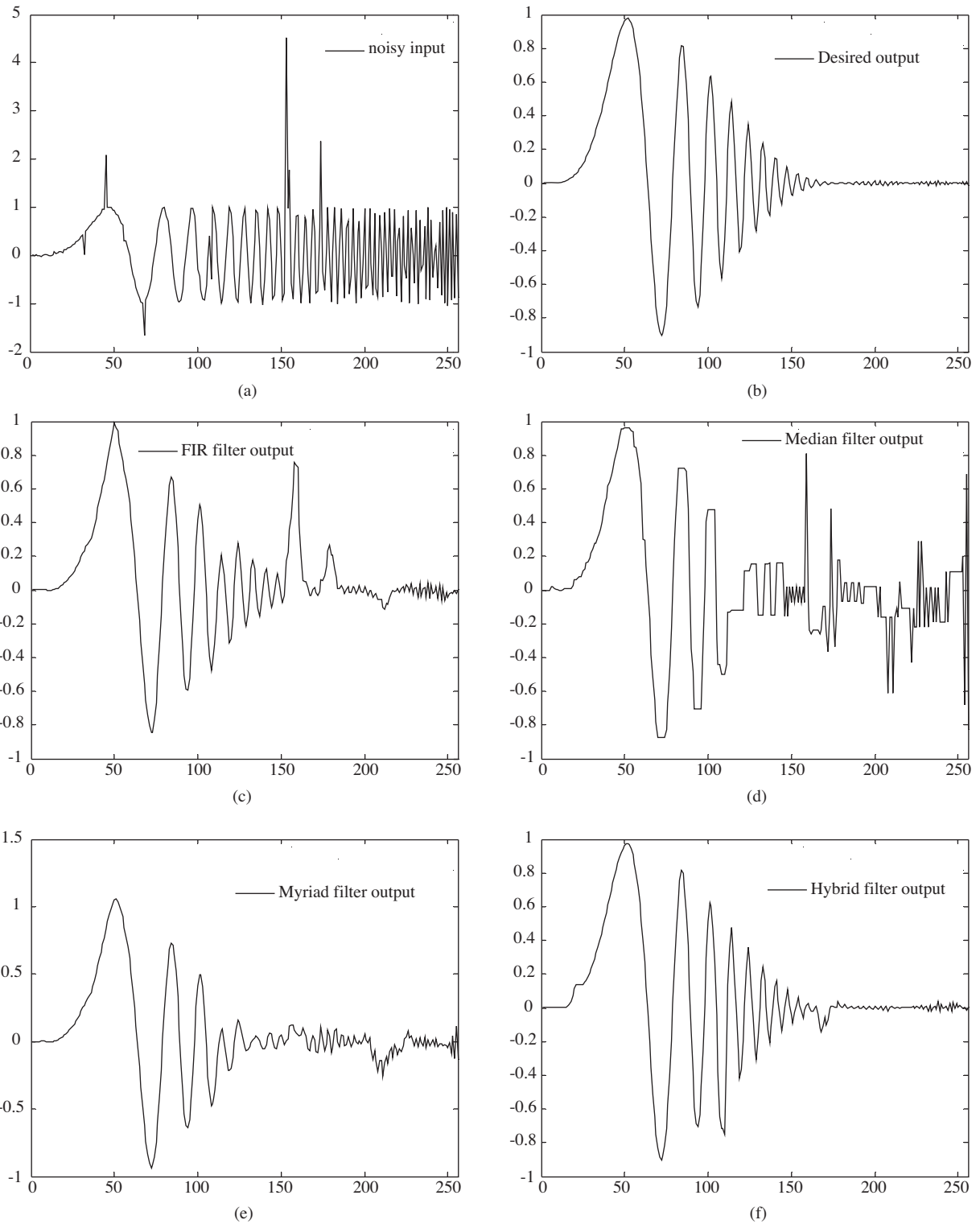


**Figure 5.** a) Noisy chirp-type signal  $s(n)$  used for testing (additive  $\alpha$ -stable noise: characteristic exponent  $\alpha = 0.1$  and dispersion  $\gamma = 0.01$ ), b) desired signal, c) FIR filter output signal, d) weighted median filter output signal, e) weighted myriad filter output signal, f) proposed hybrid filter output signal.

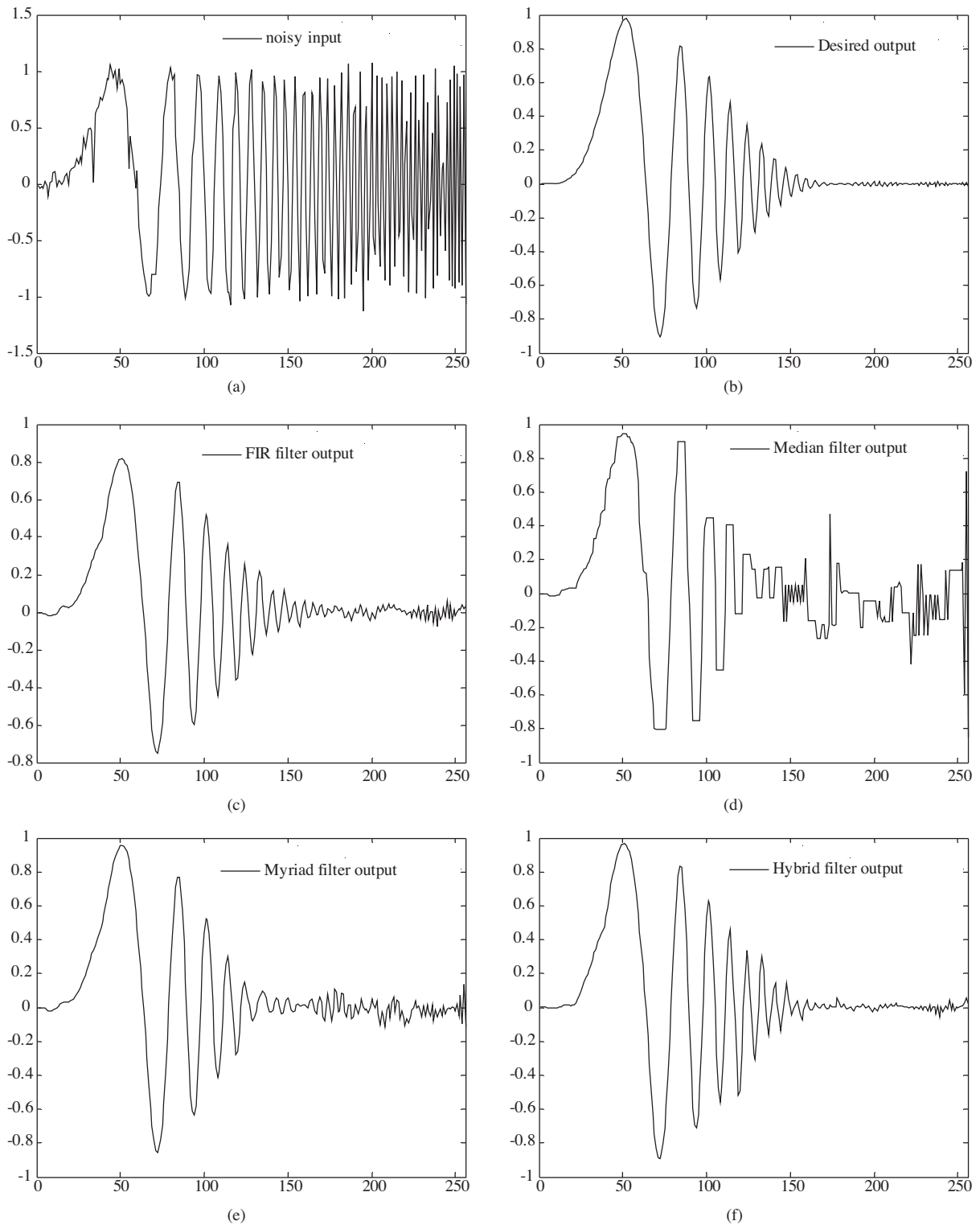




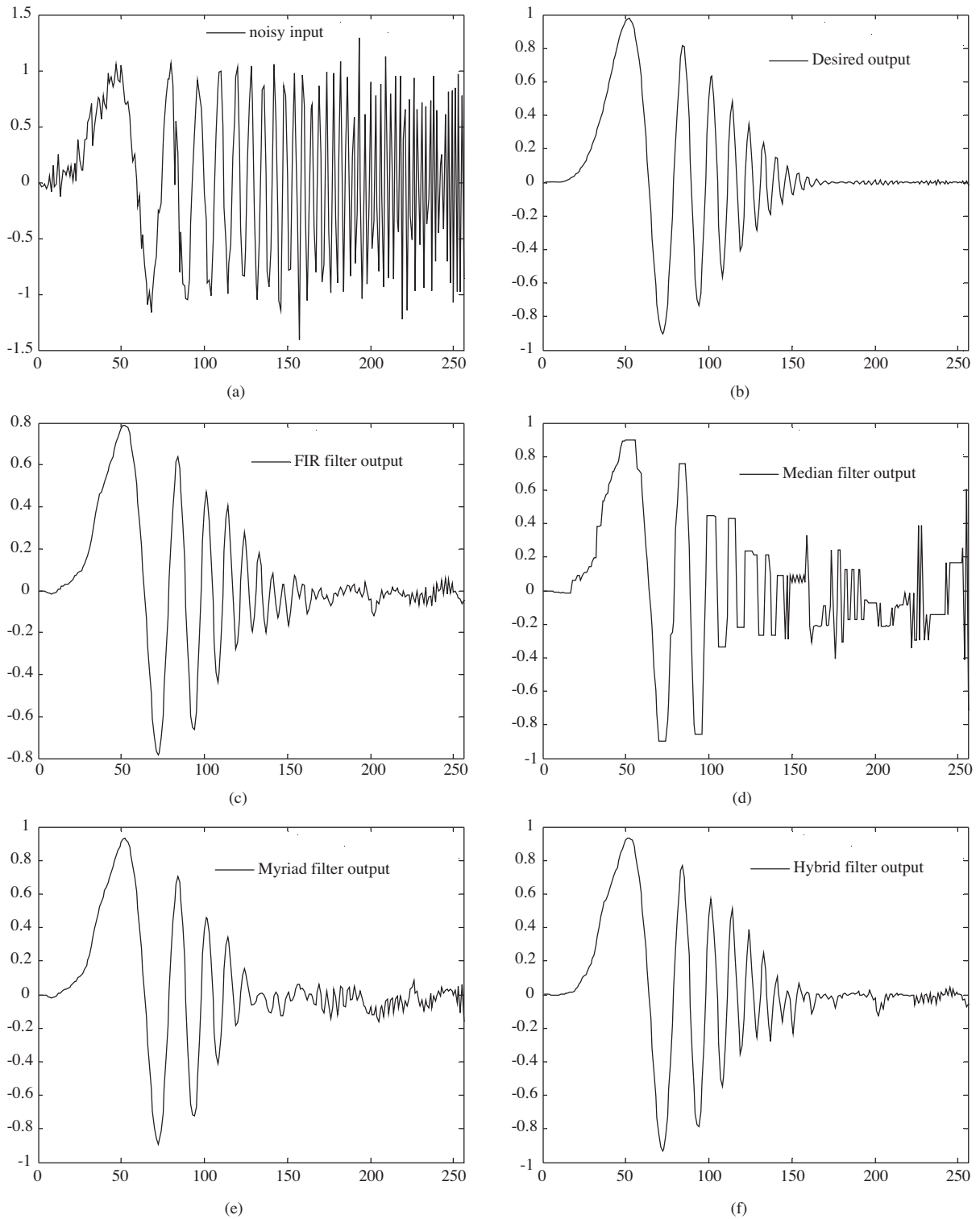
**Figure 6.** a) Noisy chirp-type signal  $s(n)$  used for testing (additive  $\alpha$ -stable noise: characteristic exponent  $\alpha = 0.4$  and dispersion  $\gamma = 0.01$ ), b) desired signal, c) FIR filter output signal, d) weighted median filter output signal, e) weighted myriad filter output signal, f) proposed hybrid filter output signal.



**Figure 7.** a) Noisy chirp-type signal  $s(n)$  used for testing (additive  $\alpha$ -stable noise: characteristic exponent  $\alpha = 0.8$  and dispersion  $\gamma = 0.01$ ), b) desired signal, c) FIR filter output signal, d) weighted median filter output signal, e) weighted myriad filter output signal, f) proposed hybrid filter output signal.



**Figure 8.** a) Noisy chirp-type signal  $s(n)$  used for testing (additive  $\alpha$ -stable noise: characteristic exponent  $\alpha = 1.3$  and dispersion  $\gamma = 0.01$ ), b) desired signal, c) FIR filter output signal, d) weighted median filter output signal, e) weighted myriad filter output signal, f) proposed hybrid filter output signal.



**Figure 9.** a) Noisy chirp-type signal  $s(n)$  used for testing (additive  $\alpha$ -stable noise: characteristic exponent  $\alpha = 1.8$  and dispersion  $\gamma = 0.01$ ), b) desired signal, c) FIR filter output signal, d) weighted median filter output signal, e) weighted myriad filter output signal, f) proposed hybrid filter output signal.

**Table.** Mean square error (MSE) values originating in filtering the test signals obtained by adding different characteristic exponents.

characteristic exponent values ( $\alpha$ parameters)	Filter Type			
	Adaptive FIR filter	Adaptive WMy filter	Adaptive WMd filter	Proposed hybrid filter
0.1	$1.3 \times 10^{10}$	0.0054	0.0234	0.0038
0.2	$3.3 \times 10^9$	0.0052	0.0233	0.0019
0.3	$2.5 \times 10^5$	0.0053	0.0234	0.0003
0.4	$2.1 \times 10^3$	0.0053	0.0236	0.0005
0.5	0.1826	0.0062	0.0300	0.0070
0.6	0.1253	0.0059	0.0244	0.0032
0.7	0.0233	0.0059	0.0246	0.0011
0.8	0.0105	0.0055	0.0282	0.0086
0.9	0.0221	0.0056	0.0269	0.0031
1.0	0.0110	0.0062	0.0333	0.0042
1.1	0.0189	0.0072	0.0253	0.0056
1.2	0.0057	0.0056	0.0268	0.0014
1.3	0.0048	0.0045	0.0239	0.0010
1.4	0.0062	0.0063	0.0273	0.0024
1.5	0.0049	0.0061	0.0261	0.0021
1.6	0.0052	0.0070	0.0295	0.0023
1.7	0.0053	0.0070	0.0251	0.0037
1.8	0.0063	0.0067	0.0305	0.0023
1.9	0.0070	0.0076	0.0255	0.0050
2.0	0.0057	0.0067	0.0308	0.0032

## 4. Conclusions

This study presents a new soft-switching hybrid filter based on a neuro-fuzzy network to improve the performance of filtering in an impulsive noisy environment. The proposed hybrid filter combined an adaptive FIR filter and an adaptive WMy filter with a soft-switching mechanism based on a neuro-fuzzy network. The performance of the proposed filter was evaluated for different impulsive  $\alpha$ -stable noises and also compared with adaptive FIR, WMy, and WMd filters. Simulation results indicated that the proposed hybrid filter had better performance than all of the other mentioned filters in impulsive noisy environments. The proposed hybrid filter suppressed the impulse noise for all  $\alpha$  parameters in the range of  $[0.1 \sim 2.0]$  successfully and efficiently, as compared with the adaptive FIR, WMy, and WMd filters.

## References

- [1] M.P. Shinde, S.N. Gupta, "Signal detection in the presence of atmospheric noise in tropics," IEEE Trans. Commun., Vol. 22, pp. 1055–1063, 1974.
- [2] P.J. Huber, Robust Statistics, New York, Wiley, 1981.
- [3] N. Suetake, E. Uchino, "An RBFN–Wiener hybrid filter using higher order signal statistics", Applied Soft Computing, Vol. 7, pp. 915–922, 2007.

- [4] N. Wiener, *Extrapolation, Interpolation and Smoothing of Stationary Time Series*, John Wiley & Sons, 1949.
- [5] R.E. Kalman, "New results in linear filtering and prediction theory", *Trans. ASME(D) J. Basic Eng.*, Vol. 83, pp. 95–108, 1961.
- [6] I. Pitas, A.N. Venetsanopoulos, *Nonlinear Digital Filters: Principles and Applications*, Dordrecht, Kluwer Academic Publishers, 1990.
- [7] J.W. Tukey, "Nonlinear (nonsuperposable) methods for smoothing data", *Congr. Rec. EASCON*, 1974.
- [8] T. Lin, P. Ta, "Partition fuzzy median filter based on fuzzy rules for image restoration", *Fuzzy Sets Syst.*, Vol. 147, pp. 75–97, 2004.
- [9] R. Ganguli, "Noise and outlier removal from jet engine health signals using weighted FIR median hybrid filters", *Mechanical Systems and Signal Processing*, Vol. 16, pp. 967–978, 2002.
- [10] X. Zhou, X. Wa, "FIR-median hybrid filters with polynomial fitting", *Digital Signal Process.*, Vol. 14, pp. 112–124, 2004.
- [11] B. Lin, C.Y. Zhang, X. Wang, C. Gu, B. Wang, "FIR-myriad hybrid filters for signal processing in impulsive noise environment", *ChinaCom 2006 First International Conference on Communications and Networking in China*, pp. 1–4, 2006.
- [12] M.E. Yuksel, A. Basturk, "Efficient removal of impulse noise from highly corrupted digital images by a simple neuro-fuzzy operator," *Int. J. Electron. Commun. (AEU)*, Vol. 57, pp. 214–219, 2003.
- [13] M.E. Yuksel, E. Besdok, "A simple neuro-fuzzy impulse detector for efficient blur reduction of impulse noise removal operators for digital images," *IEEE Trans. Fuzzy Syst.*, Vol. 12, pp. 854–865, 2004.
- [14] G. Samorodnitsky, M.S. Taqqu, *Stable Non-Gaussian Random Processes*, New York, Chapman & Hall, 1994.
- [15] S. Kalluri, *Nonlinear Adaptive Algorithms for Robust Signal Processing and Communications in Impulsive Environments*, Ph.D. dissertation, University Of Delaware, 1998.
- [16] J.G. Gonzalez, D.W. Griffith, G.R. Arce, "Matched myriad filtering for robust communications", *Proc. of the 1998 Conf. on Information Science and Systems*, Princeton University, 1998.
- [17] S. Kalluri, G.R. Arce, "A general class of nonlinear adaptive filtering algorithms", *IEEE Trans. on Signal Processing*, Vol. 47, pp. 2262–2272, 1999.
- [18] S. Kalluri, G.R. Arce, "Adaptive weighted myriad filter algorithms for robust signal processing in  $\alpha$ -stable noise environments", *IEEE Trans. on Signal Processing*, Vol. 46, pp. 322–334, 1998.
- [19] S. Haykin, *Neural Networks: A Comprehensive Foundation*, New York, Macmillan College Publishing Company, 1994.
- [20] J.T.R. Jang, C.T. Sun, E. Mizutani, *Neuro-Fuzzy and Soft Computing*, PTR Prentice Hall, 1997.
- [21] R.D. Strum, D.E. Kirk, *First Principles of Discrete Systems and Digital Signal Processing*, Reading, MA, Addison-Wesley, 1989.