

1-1-2022

On finite nonsolvable groups whose cyclic p -subgroups of equal order are conjugate

ROBERT VAN DER WAALL

SEZGİN SEZER

Follow this and additional works at: <https://journals.tubitak.gov.tr/math>



Part of the [Mathematics Commons](#)

Recommended Citation

WAALL, ROBERT VAN DER and SEZER, SEZGİN (2022) "On finite nonsolvable groups whose cyclic p -subgroups of equal order are conjugate," *Turkish Journal of Mathematics*: Vol. 46: No. 7, Article 15.
<https://doi.org/10.55730/1300-0098.3301>

Available at: <https://journals.tubitak.gov.tr/math/vol46/iss7/15>

This Article is brought to you for free and open access by TÜBİTAK Academic Journals. It has been accepted for inclusion in Turkish Journal of Mathematics by an authorized editor of TÜBİTAK Academic Journals. For more information, please contact academic.publications@tubitak.gov.tr.

On finite nonsolvable groups whose cyclic p -subgroups of equal order are conjugate

Robert W. VAN DER WAALL^{1,*} , Sezgin SEZER² 

¹Department of Mathematics, The Korteweg-de Vries Institute for Mathematics,
University of Amsterdam, Amsterdam, the Netherlands

²Department of Engineering Basic Sciences, Faculty of Engineering and Natural Sciences,
İstanbul Okan University, İstanbul, Turkey

Received: 16.02.2022

Accepted/Published Online: 03.07.2022

Final Version: 05.09.2022

Abstract: The structure of the nonsolvable (P)-groups is completely described in this article. By definition, a finite group G is called a (P)-group if any two cyclic p -subgroups of the same order are conjugate in G , whenever p is a prime number dividing the order of G .

Key words: Conjugacy classes, (generalized) Fitting subgroups, Frattini subgroups, p -subgroups, sporadic simple groups, groups of Lie type, alternating and symmetric groups, Schur multiplier, Hering's theorem, automorphism groups, (semi-)direct product of groups

1. Introduction

It is our purpose to classify completely the structure of a finite group in which any two cyclic p -subgroups of equal order are conjugate whenever p is a prime dividing the order of that group. Such a group is called a (P)-group; sometimes we will say it satisfies the (P)-property. In the introduction of [15] subclasses of the class of (P)-groups have been dealt with. In [15] itself, the structure of the finite groups G , in which any two abelian subgroups of equal order are conjugate, has been settled.

A few remarks on notations and conventions are in order. The subgroup $\mathbb{F}^*(X)$ of a finite group X , being equal to $\mathbb{F}(X)\mathbb{E}(X)$, stands for the so-called generalized Fitting subgroup of X ; here $\mathbb{F}(X)$ is the Fitting subgroup of X and $\mathbb{E}(X)$ is the subgroup of X generated by the quasisimple subnormal subgroups of X . The symbol C_n denotes a cyclic group of order n ; Q will be the quaternion group of order 8. Additional notation will be standard and self-explanatory; see [8, 16, 17, 17a, 17b]. All the groups appearing in this article will be finite.

It has been shown in ([14], (2.8) Theorem) that a group X containing different minimal normal subgroups M and N that are nontrivial is a (P)-group if and only if the factor groups X/M and X/N are (P)-groups satisfying $(|M|, |N|) = 1$. This observation will be used repeatedly in this article.

Now let us define a list \mathcal{N} of groups as follows.

$$\mathcal{N} := \bigcup \{M_{11}; M_{23}; J_1; \text{PSL}(2, 2^m) \ (m \geq 3); \text{Sz}(2^{2t+1}) \ (t \geq 1); \\ \text{PSL}(2, p^n) \ \text{and} \ \text{SL}(2, p^n) \ p \ \text{odd prime}, \ n \geq 1, n \ \text{odd}, p^n \geq 7\}$$

*Correspondence: math@tubitak.gov.tr

2010 AMS Mathematics Subject Classification: 20D06, 20D08, 20D15; 20D20, 20D25, 20D30, 20D40, 20E07, 20E45, 20F14, 20F28, 20G40

In working through the article, one will encounter the following statements with proofs.

$\underline{\alpha}$ Each group from the list \mathcal{N} is a (P)-group.

$\underline{\beta}$ Let L/K be a nonabelian chief section of a (P)-group G . Then L/K is either isomorphic to a simple group from the list \mathcal{N} , or else L/K is isomorphic to the (P)-group A_5 ($\cong \text{PSL}(2, 4)$ and $\cong \text{PSL}(2, 5)$); In addition, the groups G/L and K are solvable.

$\underline{\gamma}$ As in $\underline{\beta}$, assume p is an odd prime dividing $|L/K|$. Then p does not divide the product $|G/L||K|$.

One of the main results of the research as obtained in this article, is the following, to be called \underline{A} .

\underline{A} Let G be a nonsolvable (P)-group not admitting a chief factor isomorphic to A_5 .

Then there exists $N \trianglelefteq G$ with $N \in \mathcal{N}$, satisfying $G = NR$, R a solvable (P)-group with $\{1\} \leq R < G$, $[[R, R], N] = 1$, $(|N|, |R|) = 1$. If p divides $|R|$ and S_p is a noncyclic Sylow p -subgroup of R , then S_p is an elementary abelian normal Sylow p -subgroup of R . Let S be $\Pi_i S_{p_i}$ where $p_i || |R|$ with $S_{p_i} \in \text{Syl}_{p_i}(R)$ is noncyclic. In case $S \neq \{1\}$, then $R = SU$ with $1 \leq U < R$ and $1 = (|U|, |S|)$, U being a metacyclic (P)-group with $(|[U, U]|, |U/[U, U]|) = 1$. And if $S = \{1\}$, then R is a (possibly trivial) metacyclic (P)-group satisfying $(|R/[R, R]|, |[R, R]|) = 1$.

One also has

\underline{B} Conversely, if a group G is not solvable and it happens that G satisfies all of the further conditions in the statements of \underline{A} , then G is a (P)-group.

We have also shown that the following nice structure property \underline{C} holds.

\underline{C} Assume G is a nonsolvable (P)-group admitting one of the sporadic simple groups M_{11} , M_{23} , J_1 as a chief section (view \underline{A}). Then there exists $N \trianglelefteq G$ with $N \in \{M_{11}, M_{23}, J_1\}$ satisfying $G \cong N \times R$, the direct product of the (P)-subgroups N and R of G with $(|N|, |R|) = 1$. Conversely, if $M \in \{M_{11}, M_{23}, J_1\}$ and U is a solvable (P)-group with $(|M|, |U|) = 1$, then the direct product of M and U is a (P)-group.

Next assume that Y is a (P)-group admitting a chief factor isomorphic to A_5 . Then the full classification of those groups Y has been obtained in Section 7. Let us look at such a group Y in which Y contains possibly one minimal normal subgroup; call that subgroup M . Let us also assume that the order of $M \neq 1$ is odd. Then the structure of that group Y is embodied in one of the next three types:

- 1) A semidirect product $Y \cong M \rtimes D$ with $M \cong C_p \times C_p$ with $p \in \{11, 19, 29, 59\}$, $D \cong \text{SL}(2, 5)$ and $D \cong G/(C_p \times C_p) \hookrightarrow \text{GL}(2, p)$;
- 2) A semidirect product $Y \cong M \rtimes E$ with $M \cong C_{29} \times C_{29}$ and $D \cong \text{SL}(2, 5) \times C_7$ with $E \cong G/(C_{29} \times C_{29}) \hookrightarrow \text{GL}(2, 29)$;
- 3) A semidirect product $Y \cong M \rtimes U$ with $M \cong C_{59} \times C_{59}$ and $U \cong \text{SL}(2, 5) \times C_{29}$ with $U \cong G/(C_{59} \times C_{59}) \hookrightarrow \text{GL}(2, 59)$.

It will turn out (see Theorem 5.7) that for odd prime p , a noncyclic Sylow p -subgroup of the Fitting subgroup $\mathbb{F}(X)$ of a (P)-group X is a (in fact, the) normal Sylow p -subgroup of X . Conversely, any noncyclic Sylow

p -subgroup of a (P)-group Y with p odd and Y not admitting any $\text{PSL}(2, p^m)$ with $m \geq 2$, as chief factor, happens to be situated in $\mathbb{F}(Y)$ whenever p is a prime at least equal to 5; in the cases $p = 2$ and $p = 3$ there exist counterexamples.

Finally, notice that, essentially, the structure of any solvable (P)-group has been determined and exposed in [14], with one exception. Namely, if a solvable (P)-group admits a Suzuki 2-group S as a noncyclic Sylow 2-subgroup, it has been de facto shown that $S \trianglelefteq G$; see Section 3 below.

2. Preliminaries

We start with a few preparatory observations. The class of (P)-groups is not closed under taking subgroups, or taking extensions. Namely, as an example, the alternating group A_4 on 4 symbols is a (P)-group, whereas the unique subgroup of order 4 is noncyclic abelian but not a (P)-group. On the other hand, the property (P) is inherited by the homomorphic images of any (P)-group; (see [14], (2.2) Theorem). The next lemma (see [14], (2.1) Lemma and (2.8) Theorem) and theorems are also of importance for our purposes.

Lemma 2.1 *If $G = AB$, $A \trianglelefteq G$, $B \trianglelefteq G$ and $A \cap B \leq \mathbb{Z}(G)$, then G is a (P)-group if and only if A and B are (P)-groups with $(|A/(A \cap B)|, |B/(A \cap B)|) = 1$.*

Theorem 2.2 *Let N be a normal nonabelian simple subgroup of a group G . Assume $\mathbb{C}_G(N) = \{1\}$. Then G can be isomorphically embedded into $\text{Aut}(N)$ in such a way that G is isomorphic to a group \tilde{G} satisfying $\text{Inn}(N) \leq \tilde{G} \leq \text{Aut}(N)$ where $\text{Inn}(N) \cong N$.*

Proof Due to $\mathbb{C}_G(N) = \{1\}$, any map τ_g ($g \in G$), defined by $\tau_g(n) = gng^{-1}$, whenever $n \in N$, is an automorphism of N . The set \tilde{G} (say), consisting of all those maps, is endowed with a group structure via $\tau_{g_1g_2}(n) = (g_1g_2)n(g_1g_2)^{-1} = g_1(g_2ng_2^{-1})g_1^{-1} = \tau_{g_1}(\tau_{g_2}(n))$. Hence, $\tilde{G} \leq \text{Aut}(N)$. The group N is nonabelian simple. Therefore, $N \cong \text{Inn}(N)$, $|N| = |\text{Inn}(N)|$, and notice that $\tau_{n_1} = \tau_{n_2}$ for elements $n_1, n_2 \in N$ yield here the equality of n_1 and n_2 . Thus, $\{\tau_s : s \in N\}$ is nothing else but $\text{Inn}(N)$ itself. This completes the proof of the theorem. \square

Theorem 2.3 *Let G be a (P)-group. Suppose L/K is a chief factor of G with $L \trianglelefteq G$ and $K \trianglelefteq G$. Then either G is solvable or L/K is a nonabelian simple group and both K and G/L are solvable.*

Proof We may assume that the maximal solvable normal subgroup $\mathbb{O}_\infty(G)$ of G is smaller than G . Put $\bar{S} := U/\mathbb{O}_\infty(G)$ with $U \neq \mathbb{O}_\infty(G)$ being a minimal normal subgroup of $\bar{G} (= G/\mathbb{O}_\infty(G))$, so S is a direct product of isomorphic nonabelian simple groups \bar{S}_i ($i \in \{1, \dots, t\}$, say). By the Feit-Thompson theorem, any such S_i contains an involution with $i \in \{1, \dots, t\}$. Assume $t \geq 2$. Consider the involution $i_1 = x_1 \cdots x_{t-1}$ and the involution $i_2 = x_1x_2 \cdots x_t$. Then $|\mathbb{C}_S(i_1)| \neq |\mathbb{C}_S(i_2)|$, whence the centralizers of x_1 and x_2 in \bar{S} are of different order. This, however, contradicts the (P)-group property of \bar{G} . Thus, one must have $t = 1$, i.e. \bar{S} is nonabelian simple. Therefore, if $\mathbb{C}_{\bar{G}}(\bar{S}) \neq \{\bar{1}\}$, then $\mathbb{C}_{\bar{G}}(\bar{S})$ would contain a nontrivial nonabelian characteristic subgroup C with $C > \mathbb{O}_\infty(\bar{G})$, so $C \triangleleft \bar{G}$; whence $C \cap \bar{S} = \{\bar{1}\}$. Now C has to contain involutions by the Feit-Thompson theorem, a contradiction to the (P)-group property of $\bar{G}/\mathbb{O}_\infty(\bar{G})$ as involutions in C have to be conjugate to those in \bar{S} , so they must belong to $\bar{S} \trianglelefteq \bar{G}$. Thus, it holds that $\mathbb{C}_{\bar{G}}(\bar{S}) = \{\bar{1}\}$. Thus, it

follows \overline{G} is isomorphic to a subgroup of the automorphism group of \overline{S} . By the truth of Schreier's conjecture due to the CFSG, it, therefore, holds that there exists a unique simple normal subgroup K of $\text{Aut}(\overline{S})$ satisfying $\text{Aut}(\overline{S})/K$ being solvable, namely $K = \text{Inn}(\overline{S})$. Hence, $\overline{G}/\overline{S}$ is solvable. The Jordan-Hölder theorem now yields the full truth of the theorem. \square

Theorem 2.4 *Let G be a group for which $\mathbb{F}^*(G) = \mathbb{F}(G)\mathbb{E}(G)$ with $\mathbb{E}(G) \neq 1$. Then G is not a (P)-group unless $\mathbb{E}(G)/\mathbb{Z}(\mathbb{E}(G))$ is a nonabelian simple group.*

Proof Suppose G is a (P)-group. By ([2], 11 (31.7)), $\mathbb{E}(G)$ is the central product of its components C_i , ($i = 1, \dots, t$) where a component is defined as being any subnormal quasisimple subgroup of G . The group $G/\mathbb{Z}(\mathbb{E}(G))$, being a (P)-group, does admit a normal subgroup N isomorphic to $\mathbb{E}(G)/\mathbb{Z}(\mathbb{E}(G))$ with $N \cong \prod_{i=1}^t S_i$ where the S_i are nonabelian simple groups. Just analogously to the proof of Theorem (2.3), it holds that for $t \geq 2$, G/N (whence G too) is not a (P)-group. The theorem has been proved. \square

The next theorem due to Yamaki will be applied several times.

Theorem 2.5 *(Yamaki [19], Lemma 2, paraphrased) Let G be a group satisfying $\text{Inn}(M) \leq G \leq \text{Aut}(M)$, where M is a nonabelian simple group. Suppose that the set of involutions of M constitute at least two conjugacy classes of M . Then for any such couple $\{M, G\}$, G does contain at least two conjugacy classes of involutions.*

In the sequel of this paper, it is needed whether or not $\text{Aut}(S)$ splits over S , where S is some specified nonabelian simple group. As such we use results from the papers of Lucchini et al., and of Pandya; see respectively [12] and [13].

3. Solvable (P)-groups containing nonabelian 2-subgroups

In [14], the nonabelian Sylow 2-subgroups of a (P)-group G not yet fully treated there, were the Suzuki 2-groups different from the quaternion group Q of order 8. Here we will do so. In this section, it will currently be used that G and all its factor groups are supposed to be solvable (P)-groups, due to ([14], (2.2) Theorem).

Theorem 3.1 *Let G be a solvable (P)-group and assume that $S \in \text{Syl}_2(G)$ is a Suzuki 2-group not isomorphic to the quaternion group of order 8. Then S is a normal subgroup of G .*

Proof The proof will be given in a series of steps. Assume G is a counterexample of minimal order, to the theorem.

- 1) Suppose $|\mathbb{F}(G)|$ is divisible by an odd prime, say p .
- 1) α) Assume that there exist two minimal normal subgroups N_1 and N_2 of G each being of odd prime power order. Hence, G is isomorphic to a subgroup of the direct product $G/N_1 \times G/N_2$. Since G is a minimal counterexample to the Theorem, each of the (P)-groups G/N_1 and G/N_2 possesses a normal Sylow 2-subgroup isomorphic to S whence G too, a contradiction to the choice of G .
- 1) β) Suppose $\mathbb{F}(G) \cong S_p \times S_2$, where $S_2 \neq \{1\}$ is a 2-subgroup of S and where S_p is a p -subgroup of $\mathbb{F}(G)$ with $S_p \neq \{1\}$, p odd prime. The group S is a Suzuki 2-group, whence both $G/\Phi(S)$ and $\Phi(S) \neq \{1\}$ are elementary abelian. Next use that G and G/S_2 are solvable (P)-groups. Thus, $S_2 < \mathbb{F}(G)$ is in fact

equal to S or to $\Phi(S)$, as G permutes transitively the “elements” in the set of the cyclic subgroups of order 4 (the same argument applies for all the involutions of G). In case $S_2 = S$, then we are done; indeed, $S = S_2$ is then characteristic in $\mathbb{F}(G)$, whence normal in G , a contradiction to the choice of G , so $S_2 = \Phi(S)$ remains here to be investigated. Hence, the solvable (P)-group G/S_2 possesses a normal elementary abelian but noncyclic Sylow 2-subgroup due to ([14] (4.4) Theorem) resulting in the fact that G itself possesses a normal Sylow 2-subgroup, a contradiction to the choice of G .

1)β)a) Assume $\mathbb{F}(G)$ is a p -group with $p \neq 2$ and assume $\Phi(\mathbb{F}(G)) \neq \{1\}$. As the group $G/\Phi(\mathbb{F}(G))$ possesses now a normal Suzuki 2-subgroup not isomorphic to Q by induction, it follows that $[S\Phi(\mathbb{F}(G))/\Phi(\mathbb{F}(G)), \mathbb{F}(G)/\Phi(\mathbb{F}(G))] = \{1\}$. Hence, by ([8] III, 3.18 Satz), $[S, \mathbb{F}(G)] = 1$ holds. This is a contradiction to $\mathbb{C}_G(\mathbb{F}(G)) \leq \mathbb{F}(G)$ where the inclusion sign is fulfilled as G is solvable; see ([8] III 4.2.b Satz). We have found a contradiction.

1)β)b) Thus, let us assume that $\mathbb{F}(G)$ is a p -group with $p \neq 2$ and $\Phi(\mathbb{F}(G)) = \{1\}$. The group $\mathbb{F}(G)$ cannot be cyclic of order p . [Otherwise $G/\mathbb{F}(G) \hookrightarrow \text{Aut}(\mathbb{F}(G)) \cong C_{p-1}$ and also $\mathbb{C}_G(\mathbb{F}(G)) = \mathbb{F}(G)$ yielding a contradiction to the cyclicity of $S\mathbb{F}(G)/\mathbb{F}(G)$], so $\mathbb{F}(G)$ is elementary abelian but not cyclic. The “elements” of the set of cyclic subgroups of order p are transitively permuted under conjugation by the elements of G . Hence, by ([14], (4.2) Lemma) any normal abelian subgroup of $G/\mathbb{C}_G(\mathbb{F}(G)) (= G/\mathbb{F}(G))$ is cyclic. As the Theorem holds for the (P)-group $G/\mathbb{F}(G)$, it follows that $S\mathbb{F}(G)/\mathbb{F}(G) \triangleleft G/\mathbb{F}(G)$, whereas there has to exist a cyclic minimal normal subgroup C of the (P)-group $G/\mathbb{F}(G)$ contained in the elementary abelian 2-subgroup $\Phi((S/\mathbb{F}(G))/\mathbb{F}(G))$ of the Suzuki 2-group $S\mathbb{F}(G)/\mathbb{F}(G)$. Hence, $|C| = 2$, leading to $S \cong S\mathbb{F}(G)/\mathbb{F}(G) \cong Q$ as $G/\mathbb{F}(G)$ is a (P)-group. A contradiction as S is not isomorphic to Q by assumption.

2) There remains to investigate the situation in which $\mathbb{F}(G)$ is a nontrivial 2-group. As G is a p -group, one gets $\mathbb{F}(G)$ contains all elements of G of order 2. Notice that $\mathbb{F}(G)$ does not contain elements of order 4. [Otherwise, as G is a (P)-group satisfying $\text{Exp}(S) = 4$, one gets $\mathbb{F}(G) = S$, a contradiction as G is a minimal counterexample to the Theorem]. Hence, $\mathbb{F}(G)$ is an elementary abelian 2-group. Thus, as $\mathbb{F}(G) \leq \Omega_1(S) = \Phi(S)$ by the structure of S , one has $\mathbb{F}(G) = \Phi(S)$ and $|S/\Phi(S)| \geq 4$. The group $S/\Phi(S) \in \text{Syl}_2(G/\mathbb{F}(G))$ is an elementary abelian 2-group but not cyclic. Hence, $S/\mathbb{F}(G)$ is a normal subgroup of the (P)-group $G/\Phi(S) (= G/\mathbb{F}(G))$, due to ([14] (4.4) Theorem), so $S \triangleleft G$, a contradiction to our assumption on the structure of G .

This concludes the proof. □

Corollary 3.2 *Let G be a solvable (P)-group. Suppose G contains a Suzuki 2-group $S \not\cong Q$ with $S \in \text{Syl}_2(G)$. Then $S \trianglelefteq G$ and the (P)-group $G/\mathbb{F}(G)$ is of odd order and cyclic or metacyclic as well.*

Proof The fact that G has a normal Sylow 2-subgroup does follow from Theorem 3.1. The structure of $G/\mathbb{F}(G)$, i.e. $G/\mathbb{F}(G)$ being cyclic or metacyclic, has been shown to be true in ([14] (4.5) Corollary). □

Remark 3.3 *As a consequence of the classification of the nonsolvable (P)-groups as done later in this article, one is able to observe that no Suzuki 2-group S with $S \not\cong Q$, appears as a normal 2-subgroup of some nonsolvable*

(P)-group. In addition, notice that for $p \neq 2$, any noncyclic p -subgroup of a solvable (P)-group G has the property that it appears as an elementary abelian subgroup of $\mathbb{F}(G)$; see Sezer's theorem resulting in Theorem (4.4) in [14]. As to some analogous statement for nonsolvable (P)-groups, see the introduction and in particular Corollary 5.8 and Theorem 5.7.

4. Sporadic simple groups as sections of (P)-groups

In this section, the full structure of (P)-groups will be determined in which such a group admits a chief factor isomorphic to a sporadic simple group.

We start with the following lemma.

Lemma 4.1 *Let G be a group satisfying $\text{Inn}(M) \leq G \leq \text{Aut}(M)$ where M is a sporadic simple group. Then G is not a (P)-group unless $M \cong M_{11}$, $M \cong M_{23}$ or $M \cong J_1$.*

Proof It is well known that $|\text{Aut}(M)/\text{Inn}(M)| \leq 2$ and that $\text{Aut}(M) = \text{Inn}(M)\langle\tau\rangle$ where τ is the identity element of $\text{Aut}(M)$ or τ can be chosen as to be of order 2 in $\text{Aut}(M)$. We distinguish two cases: 1) $\text{Aut}(M) = M$; 2) $|\text{Aut}(M)/M| = 2$.

- Re 1) The groups M_{24} , J_4 , Co_1 , Co_2 , Co_3 , F_1 , F_2 , F_{23} , and Ru each contains at least two conjugacy classes of involutions, whence such a group is not a (P)-group. The group Ly contains at least two elements of order 3 whose centralizers in Ly are of different orders. Hence, Ly is not a (P)-group. The group F_3 contains at least two elements of order 4 whose centralizers in F_3 are of different orders. Hence, F_3 is not a (P)-group. The remaining groups M_{11} , M_{23} , and J_1 in this rubric 1), are indeed (P)-groups. There is much more to be said in the next Theorem 4.2 about the groups M_{11} , M_{23} , and J_1 .
- Re 2) Any group $S \in \{M_{12}, J_2, F_{22}, F'_{24}, \text{H-S}, \text{He}, \text{Suz}, F_5\}$ has at least two conjugacy classes of involutions. Hence, such a group is not a (P)-group itself. Notice that such an $\text{Aut}(S)$ is not a (P)-group due to the fact that there exists involutions in $\text{Aut}(S)$ outside S . The group J_3 contains at least two elements of order 3 whose centralizers in J_3 are of different orders, whence J_3 is not a (P)-group and $\text{Aut}(J_3)$ is not a (P)-group as $\text{Aut}(J_3)$ contains involutions outside J_3 . The remaining groups M_{22} , McL , $\text{O}'\text{N-S}$ in this rubric 2) each share the property that there are elements of order 4 in such a group, whose centralizers in that chosen group are of different orders. Hence, each of M_{22} , McL , $\text{O}'\text{N-S}$ is not a (P)-group. Recall that $\text{Aut}(M_{22})$ splits over M_{22} ; likewise does $\text{Aut}(\text{McL})$ over McL and $\text{Aut}(\text{O}'\text{N-S})$ over $\text{O}'\text{N-S}$. Thus, in the groups $\text{Aut}(M_{22})$, $\text{Aut}(\text{McL})$ and $\text{Aut}(\text{O}'\text{N-S})$, there exist involutions outside the respective normal subgroups M_{23} , McL , and $\text{O}'\text{N-S}$. Thus, each of the groups $\text{Aut}(M_{22})$, $\text{Aut}(\text{McL})$, and $\text{Aut}(\text{O}'\text{N-S})$ is not a (P)-group.

The theorem has been proved. □

The following perhaps surprising theorem gives the classification of (P)-groups in which one of the sporadic groups M_{11} , M_{23} , and J_1 is involved as a chief factor.

Theorem 4.2 *Suppose G is a group admitting at least one of the groups M_{11} , M_{23} , or J_1 as a chief factor. Then the following are equivalent.*

- 1) G is a (P)-group;

2) $G = UV$; $U \trianglelefteq G$; $V \trianglelefteq G$; $(|U|, |V|) = 1$; U is isomorphic to one of the groups M_{11} , M_{23} , J_1 ; V being a solvable (P)-group of odd order.

Proof 2) \rightarrow 1): Each of M_{11} , M_{23} , and J_1 is a (P)-group. As for M_{11} and M_{23} , one might consult the ATLAS ([6], pages 18 and 71). Regarding J_1 , observe that it is even true that any two abelian subgroups of equal order of J_1 are conjugate in J_1 ; see ([15], Proof of Theorem 4.5) The truth of the proof is a consequence of Lemma 2.1.

1) \rightarrow 2): Let us work with an alleged (P)-group G under the assumption that G is a counterexample of minimal order to the step 1) \rightarrow 2) of the Theorem.

Remember that the generalized Fitting group $\mathbb{F}^*(G)$ is equal to $\mathbb{E}(G)\mathbb{F}(G)$, where $\mathbb{F}(G)$ stands, as usual, for the Fitting subgroup G and where $\mathbb{E}(G)$ is defined as being the subgroup of G generated by its subnormal quasisimple subgroups. Notice, $\mathbb{F}^*(G) \neq \{1\}$.

We distinguish two cases: 1) $\mathbb{E}(G) \neq \{1\}$; 2) $\mathbb{E}(G) = \{1\}$.

Re 1) Assume $\mathbb{E}(G) \neq \{1\}$. Due to Theorem 2.3 and the Jordan-Hölder theorem one has $\mathbb{E}(G)/\mathbb{Z}(G) \cong S$, where S is one of the simple groups M_{11} , M_{23} , or J_1 . It is known that each of M_{11} , M_{23} , J_1 has a trivial Schur multiplier, see ([11], page 284). Therefore, $[\mathbb{E}(G), \mathbb{E}(G)] \cap \mathbb{Z}(\mathbb{E}(G))$, being isomorphic to a subgroup of the Schur multiplier of S , is trivial, see ([11], 2.1.7 Theorem). Hence, as $\mathbb{E}(G) = [\mathbb{E}(G), \mathbb{E}(G)]$, $\mathbb{E}(G)$ is simple. Put $K = \mathbb{E}(G)$. Hence, $K \cong M_{11}$ or $K \cong M_{23}$ or $K \cong J_1$. It is also known that $\text{Aut}(K) \cong K$ for any of the three choices for K ; view ATLAS [6]. Thus, each of those K is a complete group yielding $G = K\mathbb{C}_G(K)$ by ([5], exercise 10, page 96). Since each of these K is nonabelian simple, we conclude that $G = K \times \mathbb{C}_G(K)$. Moreover, $\mathbb{C}_G(K) \cong G/K$, whence $\mathbb{C}_G(K)$ is a (P)-group too. Furthermore, notice that all involutions of the (P)-group G belong to the subgroup K . Thus, by the Feit-Thompson theorem, $\mathbb{C}_G(K)$ is solvable of odd order, possibly trivial. Notice also that $(|K|, |\mathbb{C}_G(K)|) = 1$ has to hold due to Lemma 2.1 as indeed G , K and $\mathbb{C}_G(K)$ happen to be (P)-groups here. Therefore, we have found a contradiction to the choice of G as being a minimal counterexample to the truth of the step 1) \rightarrow 2).

Re 2) Suppose $\mathbb{E}(G) = \{1\}$, so $\mathbb{F}^*(G) = \mathbb{F}(G)$ holds now. Hence, the important implication

$$\mathbb{C}_G(\mathbb{F}(G)) = \mathbb{C}_G(\mathbb{F}^*(G)) \leq \mathbb{F}^*(G) = \mathbb{F}(G)$$

happens to be the case; as to the salient \leq sign property, it is to be found in ([10], X.13-12).

We distinguish two cases: a) $\mathbb{F}(G)$ is cyclic; b) $\mathbb{F}(G)$ is noncyclic.

Re 2)a) Assume $\mathbb{F}(G)$ is cyclic; notice $\mathbb{F}(G) = \mathbb{F}^*(G) \neq \{1\}$. It holds that $G/\mathbb{F}(G)$, being equal to $G/\mathbb{C}_G(\mathbb{F}(G))$ now, is a subgroup of the abelian group $\text{Aut}(\mathbb{F}(G))$. Hence, G is solvable; indeed we know that $\mathbb{F}(G)$ is nilpotent, whence solvable, so G is not an alleged counterexample.

Re 2)b) Assume $\mathbb{F}(G)$ is not cyclic. We distinguish two cases: 1) $\mathbb{F}(G) = S_p L$ with $\{1\} \neq S_p \in \text{Syl}_p(G)$ for some prime p and $\{1\} \neq L \trianglelefteq \mathbb{F}(G)$; 2) $\mathbb{F}(G)$ being a noncyclic p -group for some prime p .

Re 2)b)1) Here $\mathbb{F}(G) = S_p L$ with $S_p \cap L = \{1\}$ and $[S_p, L] = \{1\}$, $S_p \in \text{Syl}_p(\mathbb{F}(G))$, $L \neq \{1\}$ is assumed. Thus, $p \nmid |L|$, while $L \trianglelefteq G$ holds here. As G is a counterexample to the step 1) \rightarrow 2) of minimal order of the theorem, we get that the nonsolvable (P)-group G/L is of the form SR with $[S, R] = \{1\}$, where

S is isomorphic to one of the groups M_{11} , M_{23} , J_1 and where R happens to be a solvable (P)-group satisfying $(|S|, |R|) = 1$. Likewise $G/S_p = \bar{S}R_2$ with $(|\bar{S}|, |R_2|) = 1$. It follows that the maximal normal solvable subgroup $\mathcal{O}_\infty(G)$ of G satisfies $G/\mathcal{O}_\infty(G) \cong S$ with $(|G/\mathcal{O}_\infty(G)|, |\mathcal{O}_\infty(G)|) = 1$. Hence, by the Schur-Zassenhaus Theorem, there exists $\bar{\bar{S}} \leq G$ with $\bar{\bar{S}} \cong S$. Consider the group $\mathbb{F}(G)\bar{\bar{S}}$. Notice $\mathbb{F}(G)\bar{\bar{S}} \trianglelefteq G$. [Indeed, $G/\mathbb{F}(G)$ is a nonsolvable (P)-group satisfying $G/\mathbb{F}(G) = \mathbb{F}(G)\bar{\bar{S}}/\mathbb{F}(G) \times R_3$ where $R_3 \leq G/\mathbb{F}(G)$ with $(|\bar{\bar{S}}|, |R_3|) = 1$ by induction in respect to the assertion of the step 1) \rightarrow 2) of the theorem; because G is a minimal counterexample] There exist some $1 \neq s \in \bar{\bar{S}}$ and $1 \neq \sigma \in S_p$. Thus, $(sL)(\sigma L)(sL)^{-1} \in (\sigma L)(G/L)$, i.e. $s\sigma s^{-1} \in \sigma L$. Also $s\sigma s^{-1} \in S_p$, as $S_p \trianglelefteq G$. Thus, $s\sigma s^{-1} \in S_p \cap \sigma L$ holds. Since $[S_p, L] = \{1\}$, and $p \nmid |L|$, it yields that $s\sigma s^{-1} = \sigma$ is fulfilled. Analogously, one finds for $l \in L$ that $sls^{-1} \in L \cap S_p$. As no prime divisor of $|L|$ divides $|S_p|$, one gets $sls^{-1} = l$ due to $[S_p, L] = \{1\}$. Hence, $s \in \mathbb{C}_G(S_p L) = \mathbb{C}_G(\mathbb{F}(G)) \leq \mathbb{F}(G)$ in this rubric Re2)b)1). Since $(|\bar{\bar{S}}|, |\mathbb{F}(G)|) = 1$, one gets so, that $s = 1$ must hold, a contradiction to $s \neq 1$.

Re 2)b)2) Assume $\mathbb{F}^*(G) = \mathbb{F}(G)$, where $\mathbb{F}(G)$ is a noncyclic p -subgroup of G for some prime p . We split up once more: α) The Frattini group $\Phi(\mathbb{F}(G))$ of $\mathbb{F}(G)$ is not trivial; β) $\Phi(\mathbb{F}(G)) = \{1\}$.

Re 2)b)2) α) Suppose that in Re2)b)2) $\Phi(\mathbb{F}(G)) \neq \{1\}$ holds. Since G is a counterexample of minimal order to the assertion of the 1) \rightarrow 2) -part of the Theorem and so $G/\Phi(\mathbb{F}(G))$ is a nonsolvable (P)-group, it holds that $G/\Phi(G) \cong S \times V$ with $S \cong M_{11}$ or $S \cong M_{23}$ or $S \cong J_1$ satisfying $(|S|, |V|) = 1$; notice indeed $\mathbb{F}(G)/\Phi(\mathbb{F}(G)) \neq \{1\}$. Hence, there exists $1 \neq s \in G \setminus \mathbb{F}(G)$ with $p \nmid |s|$ centralizing $\mathbb{F}(G)/\Phi(G)$. Thus, s acts trivially by conjugation on the whole of $\mathbb{F}(G)$ by a theorem of Burnside; see ([8], III. 18.b Satz). We have got here a contradiction to the fact that $\mathbb{C}_G(\mathbb{F}(G)) \leq \mathbb{F}(G)$.

Re 2)b)2) β) Suppose $\mathbb{F}^*(G) = \mathbb{F}(G)$ is a noncyclic elementary abelian p -group. We have $\mathbb{C}_G(\mathbb{F}(G)) = \mathbb{F}(G) \neq \{1\}$ in this rubric. Suppose $|\mathbb{F}(G)| = p^n$ for some specific $n \in \mathbb{N}$. We have $n \geq 2$. [Indeed $n = 1$ leads to $\mathbb{F}(G)$ being cyclic, which is not true here.] Therefore, $G/\mathbb{F}(G)$, being equal to $G/\mathbb{C}_G(\mathbb{F}(G))$, acts like a subgroup of $GL(n, p)$ on the additive subgroup of $(\mathbb{F}_p^n)^+$ of the field \mathbb{F}_p^n with $\#\mathbb{F}_p^n = p^n$. The groups G and $G/\mathbb{F}(G)$ are (P)-groups. Therefore, the group $\bar{G} \leq GL(n, p)$, being isomorphic to $G/\mathbb{F}(G)$, does act transitively on the set consisting of the lines of the n -dimensional vector space over \mathbb{F}_p . Look at the group \hat{G} , being defined as $\hat{G} = \bar{G}Z$ with Z the center of $GL(n, p)$. Notice $\bar{G} \trianglelefteq \hat{G}$. Then \hat{G} acts transitively on the set of the elements of $(\mathbb{F}_p^n)^+ \setminus \{0\}$. Now, due to the Jordan–Hölder theorem and the fact that the (P)-group \bar{G} admits precisely one nonabelian chief factor C in each chief series, we deduce from Lemma 2.1 that C is a simple group satisfying $C \cong M_{11}$ or $C \cong M_{23}$ or $C \cong J_1$. The corresponding nonabelian simple chief factor structure is also available for the group \hat{G} . Therefore, we are allowed to invoke the results of a crucial theorem due to Hering, see ([10], XII 7.5 Remark). As such, the group \hat{G} should be an example derived from nine particular group structures. On the other hand, by induction it appears that none of those nine group structures admits any of the groups M_{11} , M_{23} , and J_1 as a chief factor. Hence, an eventual structure as considered in Re2)b)2) β) does not occur.

In conclusion, all contingencies have been accounted for. No counterexample to the assertion in the 1) \rightarrow 2) direction of the Theorem does exist.

The theorem has been proved. □

We will encounter the contents of Hering's classification, mentioned above in the proof of Theorem 4.1 several times later on in our article. As such, we will use the terminology "Hering's theorem", as occurring in ([10], XII 7.5 Remark).

5. Nonsporadic nonabelian chief factors of (P)-groups

In this section, the structure of a nonabelian chief factor, if any, of a (P)-group will be determined. In any nonsolvable (P)-group G , there exists $K \trianglelefteq G$ and $L \trianglelefteq G$ with $L > K$ and L/K nonabelian simple with G/L solvable and K solvable by Theorem 2.2 in conjunction with the Jordan–Hölder theorem; furthermore, the groups G/K and G/L are then (P)-groups too. These considerations lead to the determination of the possible structures of L/K (and more), described in Theorems 5.1, 5.2, 5.3, and 5.4 and in Corollary 5.6 (and yet more specifically in Sections 6 and 7).

Theorem 5.1 *Let G be a (P)-group. Suppose G contains a nonabelian minimal normal subgroup M . Then M is simple. In addition, M happens to be a group from one of the four following lists of groups.*

- a) M_{11}, M_{23}, J_1 ;
- b) $\text{PSL}(2, q)$ with $q = p^n$, p odd prime, n odd, $q \neq 3$;
- c) $\text{PSL}(2, 2^a)$ with $a \geq 2$;
- d) $\text{Sz}(2^{2a+1})$ with $a \geq 1$.

Each of the groups from a), b), c), and d) is a (P)-group itself.

Proof The fact that M is simple has been shown in Theorem 2.2. In order to show the truth of the second assertion, we may assume w.l.o.g. that $\mathbb{C}_G(M) = \{1\}$. [Indeed, apply induction on the (P)-group $G/\mathbb{C}_G(M)$ in combination with the Jordan–Hölder theorem]. Thus, we can regard M as being equal to its own inner automorphism group satisfying $M \leq G \leq \text{Aut}(M)$ with $M \trianglelefteq \text{Aut}(M)$. Now we are able to apply Yamaki's Theorem mentioned in Section 2. [Indeed, the nonabelian simple group M contains an involution by the Feit-Thompson theorem, and as G is a (P)-group and M is normal in G , all the involutions belong to M]. Hence, leaving aside the (P)-groups $M \in \{M_{11}, M_{23}, J_1\}$, we are allowed to focus our attention to those simple groups of Lie type and those simple alternating groups in which each of them contains precisely one conjugacy class of involutions. As such, by the CFSG, consider the list of the following thirteen classes of groups.

- 1) $\text{PSL}(2, q)$, q odd, $q > 3$;
- 2) $\text{PSL}(3, q)$, q odd;
- 3) $\text{PSL}(4, q)$, $q \equiv 5 \pmod{8}$;
- 4) $\text{PSU}(3, q)$, q odd;

- 5) $\text{PSU}(4, q)$, $q \equiv 3 \pmod{8}$;
- 6) ${}^3\text{D}_4(q)$, q odd;
- 7) $G_2(q)$, q odd;
- 8) ${}^2G_2(q)$, $q = 3^{2t+1}$, $t \geq 1$;
- 9) $\text{PSL}(2, 2^a)$, $a \geq 2$;
- 10) $\text{PSL}(3, 2^b)$, $b \geq 1$;
- 11) $\text{PSU}(3, 2^c)$, $c \geq 2$;
- 12) $\text{Sz}(2^{2t+1}) = {}^2\text{B}_2(2^{2t+1})$, $t \geq 1$;
- 13) the alternating groups A_5 , A_6 , and A_7 .

We handle each class in the following sequence one after another, as follows.

13) 2) 3) 4) 5) 6) 7) 8) 10) 11) 1) 9) 12)

Re 13) Here only the group A_5 remains to be treated, due to arguments in the sequel [Notice that $A_5 \cong \text{PSL}(2, 4) \cong \text{PSL}(2, 5)$]. The group A_5 has the property that any two subgroups of equal order are conjugate in A_5 ; see ([17a], Introduction).

Next, suppose that there would exist a (P)-group \overline{G} admitting a normal subgroup S isomorphic to the alternating group on seven symbols, A_7 . We are allowed to identify A_7 with $\text{Inn}(\overline{G})$ due to the fact that not only $\overline{G}/\text{C}_{\overline{G}}(S)$ can be regarded as a (P)-subgroup of $\text{Aut}(S)$ but also that w.l.o.g. we may assume $\text{C}_{\overline{G}}(S) = \{1\}$. Next, note that $\text{Aut}(S) \cong S_7$, the symmetric group on seven symbols. The group S_7 does split over A_7 , i.e. S_7 does contain involutions outside A_7 . Of course, A_7 contains involutions, so S_7 is not a (P)-group. The group A_7 does contain elements of order 3, such as (123) and (123)(456), whose centralizers in A_7 are of distinct orders. Thus, A_7 itself is not a (P)-group. Thus, \overline{G} is not a (P)-group either.

Next, we consider a group G satisfying $M \cong A_6$ and $M \trianglelefteq G$. Consider $G/\text{C}_G(M)$. That group is isomorphic to a subgroup of $\text{Aut}(M)$. Here we have a notorious well-known situation. We are allowed to identify M with $\text{Inn}(M)$ due to the fact that we will show that $G/\text{C}_G(M)$ is not a (P)-group thereby yielding that G is not a (P)-group too. We have $\text{Aut}(M)/M \cong C_2 \times C_2$. Thus, there are three maximal subgroups T_1 , T_2 , and T_3 of $\text{Aut}(M)$, each containing M as a normal subgroup. The structure of the groups T_i , $i = 1, 2, 3$ is as follows

- α) $T_1 \cong S_6$, the symmetric group on six symbols. The group T_1 splits over M , so T_1 is not a (P)-group as there are involutions inside and outside M in T_1 . Hence, the full group $\text{Aut}(M)$ is not a (P)-group.
- β) $T_2 \cong \text{PGL}(2, 9)$. The group T_2 is, therefore, a split extension over M , so T_2 is not a (P)-group, as there are involutions T_2 inside and outside M .

γ) $T_3 \cong M_{10}$, the Mathieu group on ten symbols. The group T_3 does not split over M , so that we have to do some extra work. Denote by $S(2)$ a Sylow 2-subgroup of T_3 . Hence, $S(2)$ is semidihedral of order 16. Any Sylow 2-subgroup S of A_6 (or M) is isomorphic to a dihedral group of order 8. Notice $S(2) \cap M \cong S$ due to $M \trianglelefteq T_3$. Next observe that the nontrivial right coset of $S(2) \cap M$ in $S(2)$ consists of four elements of order 8 and four elements of order 4. Hence, T_3 contains (at least) two cyclic groups of order 4 of which one is a subgroup of the normal subgroup M of T_3 and the other one is contained in T_3 but not in M . Thus, T_3 is not a (P)-group as these two cyclic groups of order 4 are not conjugate in T_3 .

Observe that the group A_6 is not a (P)-group itself as the two subgroups $\langle(123)\rangle$ and $\langle(123)(456)\rangle$ are not conjugate in A_6 itself.

This settles the case 13).

Re 2) 3) 4) 5) 6) 7) 8) In each of these alleged possibilities of M , it is known that there exist cyclic groups of order p (in 8): $p = 3$ which are not conjugate to each other in $\text{Aut}(M)$. Hence, none of those M does occur as normal subgroup of some (P)-group.

Re 10) In any of the groups $\text{PSL}(3, 2^b)$ with $b \geq 1$, it holds that for a prime d dividing $2^b - 1$ with $d \neq 3$, there exist cyclic subgroups of order d which are not conjugate in $\text{Aut}(\text{PSL}(3, 2^b))$; see the arguments analogous to those in ([18] proof of Theorem 11), so let us look at the diophantine equation

$2^b - 1 = 3^u$ for $(b, u) \in \mathbb{Z}_{\geq 0} \times \mathbb{Z}_{\geq 0}$. Only $(b, u) \in \{(2, 1), (1, 0)\}$ do remain as solutions, see Lemmas D and E in [18]. The group $\text{PSL}(3, 2)$ is isomorphic to $\text{PSL}(2, 7)$ which is a (P)-group. The automorphism group of $\text{PSL}(3, 4)$ splits over $\text{Inn}(\text{PSL}(3, 4))$, see [13]. The group $\text{Out}(\text{PSL}(3, 4))$ is isomorphic to $C_2 \times S_3$, whence of order 12, see ([6], pages 23-25). Therefore, an alleged (P)-group with $M \trianglelefteq G \leq \text{Aut}(\text{PSL}(3, 4))$ and $M \cong \text{PSL}(3, 4)$ might only be equal to M itself [Indeed, such a G with $G > M$ contains elements of order 2 and order 3 outside M whereas M does contain elements of these orders too, a contradiction to the (P)-group property of G]. On the other hand, $\text{PSL}(3, 4)$ does contain at least two conjugacy classes of subgroups of order 3 in $\text{PSL}(3, 4)$ implying though that $\text{PSL}(3, 4)$ itself is not a (P)-group. All this settles the case 10).

Re 11) Our notation is such that $\text{PSU}(3, 2^c)$ is isomorphic to a subgroup of $\text{PSL}(3, 2^{2c})$. It is well known for $c = 2$ and each of $c \geq 4$, there exists a prime t_c dividing $2^{2c} - 1$ satisfying $t_c \nmid 2^i - 1$ for each $i \in \{1, \dots, 2c - 1\}$. Fix such a t_c . Then there exist cyclic groups of order t_c which are not conjugate in $\text{Aut}(\text{PSU}(3, 2^c))$; see the arguments analogous to those inside the proof of Theorem 7 in [18]. Finally, the group $\text{PSU}(3, 8)$ does contain elements x and y , each of order 3, whose centralizers in $\text{PSU}(3, 8)$ are of different orders, see [[6], pages 64-66]. As such, $\langle x \rangle$ and $\langle y \rangle$ are not conjugate in $\text{Aut}(\text{PSU}(3, 8))$: This settles the case 11).

Re 1) Here we will look at the groups $\text{PSL}(2, p^n)$ where p is an odd prime and $n \geq 1$. We distinguish two cases:
 a) n even; b) n odd

Re 1)a) Let n be even. Then $\text{Out}(\text{PSL}(2, p^n)) \cong C_2 \times C_n$ holds. Let φ be the unique field automorphism of order 2 of the field \mathbb{F}_q , where $q = p^n$ (n even) and consider the inclusion map $\text{PSL}(2, p^n) \langle \varphi \rangle \hookrightarrow \text{Aut}(\text{PSL}(2, p^n))$. Let σ be a 2-element of $\text{Aut}(\text{PSL}(2, p^n))$ such that $\sigma^2 \in \text{PSL}(2, q)$ and $\text{PGL}(2, q) \cong \text{PSL}(2, q) \langle \sigma \rangle$. Any maximal subgroup of $\text{Aut}(\text{PSL}(2, q))$ containing $\text{Inn}(\text{PSL}(2, q))$ does contain at least one of the groups

$\text{PSL}(2, q)\langle\sigma\rangle$, $\text{PSL}(2, q)\langle\sigma\varphi\rangle$, $\text{PSL}(2, q)\langle\varphi\rangle$; label these subgroups as (*), (**), (***), respectively. Let $H_1 \leq \text{Aut}(\text{PSL}(2, q))$ be any group containing(***)). The group (***) splits over $\text{PSL}(2, q)$, whence H_1 does contain involutions not contained in $\text{PSL}(2, q)$. Hence, H_1 is not a (P)-group. Next let us look at a group H_2 containing (**). The group (**) does contain elements of order 4 which are not contained in the normal subgroup $\text{PSL}(2, q)$ of (**), whereas $\text{PSL}(2, q)$ does also contain elements of order 4. Hence, it cannot be that H_2 is a (P)-group. Next let us look at a group H_3 containing (*). It is well-known that $\text{PGL}(2, q)$ does split over $\text{PSL}(2, q)$. Therefore, there are involutions in H_3 not contained in the normal subgroup $\text{PSL}(2, q)$ of H_3 . Thus, H_3 is not a (P)-group. As such the whole group $\text{Aut}(\text{PSL}(2, q))$ is not a (P)-group. The group $\text{PSL}(2, q)$ itself with $q = p^n$, p odd prime, n even, has the property that it contains precisely two conjugacy classes of cyclic subgroups of order p , see Dickson ([7], § 249). Thus, such a group $\text{PSL}(2, q)$ is not (P)-group.

Next recall that $\text{Out}(\text{PSL}(2, q)) \cong C_2 \times C_n$, whence that for even n with $n = 2^\alpha m$ with $\alpha \geq 1$ and m odd, $C_2 \times C_n \cong C_2 \times C_{2^\alpha} \times C_m$ does hold too. Look at any group H with $\text{PSL}(2, p^n) \leq H \leq \text{Aut}(\text{PSL}(2, p^n))$. It is known that for any subgroup U of $C_2 \times C_{2^\alpha} \times C_m$ the equality $U = (U \cap (C_2 \times C_{2^\alpha})) \times (U \cap C_m)$ holds as m is odd. Hence, we see that for groups H with $2 \mid |H/\text{PSL}(2, q)|$, H belongs to one of the groups of the types H_1 , H_2 , and H_3 we dealt with above, so we are allowed, at least, to confine ourselves to groups H with $|H/\text{PSL}(2, q)|$ being odd. We know already that $\text{PSL}(2, p^n)$, with p an odd prime, n even, contains precisely two conjugacy classes of cyclic subgroups of order p ; let us call these classes \mathbb{C}_1 and \mathbb{C}_2 . Let us assume for the moment that H is a (P)-group. Then $\mathbb{C}_1 \cup \mathbb{C}_2$ would be the unique full conjugacy class in H of cyclic subgroups of order p . Let $C \in \mathbb{C}_1$ be such a group. We get then, according to Dickson's § 249 in [7], $\#(\text{groups in } \mathbb{C}_1 \cup \mathbb{C}_2) = |H : \mathbb{N}_H(C)| = |H : \text{PSL}(2, q)\mathbb{N}_H(C)| \cdot |\text{PSL}(2, q)\mathbb{N}_H(C) : \mathbb{N}_H(C)|$. Now $2 \nmid |H : \text{PSL}(2, q)\mathbb{N}_H(C)|$, as the last number divides the odd integer $|H : \text{PSL}(2, q)|$.

We have $|\text{PSL}(2, q)\mathbb{N}_H(C) : \mathbb{N}_H(C)| = |\text{PSL}(2, q) : \mathbb{N}_H(C) \cap \text{PSL}(2, q)| = |\text{PSL}(2, q) : \mathbb{N}_{\text{PSL}(2, q)}(C)| = \# \{\text{conjugacy class of } C \text{ in } \text{PSL}(2, q)\} = \frac{p^{2n}-1}{2(p-1)}$ by § 247 in [7]. Let \bar{C} be a group of order p contained in the class \mathbb{C}_2 . Also by § 247 in [7], $\frac{p^{2n}-1}{2(p-1)} = \# \{\text{conjugacy class of } \bar{C} \text{ in } \text{PSL}(2, q)\}$. Hence, $|H : \mathbb{N}_H(\bar{C})| = \# \{\text{groups in } \mathbb{C}_1 \cup \mathbb{C}_2\} = \frac{p^{2n}-1}{p-1} = 2 \cdot |\text{PSL}(2, q) : \mathbb{N}_{\text{PSL}(2, q)}(\bar{C})| = 2 \cdot \frac{p^{2n}-1}{2(p-1)} = 2 \cdot |\text{PSL}(2, q)\mathbb{N}_H(\bar{C}) : \mathbb{N}_H(\bar{C})| = |H : \text{PSL}(2, q)\mathbb{N}_H(\bar{C})| \cdot |\text{PSL}(2, q)\mathbb{N}_H(\bar{C}) : \mathbb{N}_H(\bar{C})| = |H : \text{PSL}(2, q)\mathbb{N}_H(\bar{C})| \cdot |\text{PSL}(2, q) : \mathbb{N}_{\text{PSL}(2, q)}(\bar{C})|$, a contradiction to $2 \nmid |H : \text{PSL}(2, q)\mathbb{N}_H(\bar{C})|$ earlier established. Hence, all this settles the case 1)a).

Re 1)b) Look at $\text{PSL}(2, p^n)$, p odd and n an odd integer. Then it is known, as n is an odd, that the union of the cyclic p -subgroups of that group constitutes precisely one full conjugacy class of order p ; see ([7], §249). Any Sylow p -subgroup of $\text{PSL}(2, p^n)$ is elementary abelian. Any other Sylow r -subgroup of $\text{PSL}(2, p^n)$ here, is cyclic for odd primes $r \neq p$. Hence, any two cyclic subgroups of equal r -power order are conjugate in $\text{PSL}(2, p^n)$. It is a fact that in $\text{PSL}(2, p^n)$ all involutions do fall into one conjugacy class of involutions. The Sylow 2-subgroups of $\text{PSL}(2, p^n)$ are dihedral. Hence, all cyclic 2-groups of order

2^a for some prescribed integer $a \geq 2$, are conjugate to each other in $\text{PSL}(2, p^n)$. Notice that the Sylow 2-subgroups of $\text{PSL}(2, p^n)$ are conjugate to each other in $\text{PSL}(2, p^n)$ and each such Sylow 2-subgroup (of order 2^a) contains exactly one cyclic subgroup of any prescribed 2-power order at least equal to 4. In conclusion, any group $\text{PSL}(2, p^n)$, p odd prime, n odd, is a (P)-group itself [As a lagniappe, notice that $\text{PSL}(2, 3)$ is a solvable (P)-group of order 12; it is isomorphic to the alternating group A_4].

Hence, case 1)b) has been settled.

Re 9) Consider the group $\text{PSL}(2, 2^a)$ with $a \geq 2$. All involutions in $\text{PSL}(2, 2^a)$ do fall in one conjugacy class of involutions of $\text{PSL}(2, 2^a)$. The Sylow 2-subgroups of $\text{PSL}(2, 2^a)$ are elementary abelian. All other Sylow r -subgroups with r odd prime, are cyclic; see ([8], 8.10 Satz). Hence, any two cyclic subgroups of equal r -power order in $\text{PSL}(2, 2^a)$ are conjugate to each other. Thus, any such $\text{PSL}(2, 2^a)$ is a (P)-group. [Notice $\text{PSL}(2, 2) \cong S_3$, the solvable symmetric group on three symbols, which is a (P)-group].

This settles case 9).

Re 10) Here we treat the groups $\text{Sz}(2^{2t+1})$; or, in different notation, ${}^2\text{B}_2(2^{2t+1})$, with $t \geq 1$. All Sylow r -subgroups of $\text{Sz}(2^{2t+1})$ are cyclic where r is an odd prime; see ([10], XI. 3.7.c Remark). Any such group $\text{Sz}(2^{2t+1})$ has all its involutions conjugate. There exist in $\text{Sz}(2^{2t+1})$ precisely two conjugacy classes of elements of order 4. Hence, $\text{Sz}(2^{2t+1})$ contains precisely one conjugacy class of cyclic subgroups of order 4. Thus, we conclude that the groups $\text{Sz}(2^{2t+1})$ $t \geq 1$ are (P)-groups themselves.

This settles the case 10).

The proof of the theorem is complete. □

In the next theorem, we present a kind of a converse situation, as follows.

Theorem 5.2 *Let G be a group with $N \trianglelefteq G$, where N is one of the following groups.*

- a) $N \cong \text{PSL}(2, p^n)$, p odd prime number, n odd integer, $p^n \neq 3$;
- b) $N \cong \text{PSL}(2, 2^a)$, $a \geq 2$;
- c) $N \cong \text{Sz}(2^{2c+1})$, $c \geq 1$.

Let K be a subgroup of G with $N\text{C}_G(N) \leq K \leq G$.

Then K is a (P)-group if and only if

- 1) $(|K/N\text{C}_G(N)|, |N\text{C}_G(N)/\text{C}_G(N)|) = 1$; and
- 2) $K/N\text{C}_G(N)$ is a cyclic group whose order divides n in case a), a in case b), $2c + 1$ in case c); and
- 3) $(|N|, |\text{C}_G(N)|) = 1$; and
- 4) K/N is a (P)-group.

Proof

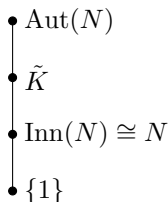

The group $NC_G(N)/C_G(N)$ is a normal nonabelian simple subgroup of $K/C_G(N)$, as $N \cap C_G(N) = \{1\}$ due to the simplicity of N . Notice that $NC_G(N)/C_G(N) \cong N$ now. Hence, $K/C_G(N)$ can be isomorphically embedded in $\text{Aut}(N)$ in such a way that $\tilde{K} \cong K/C_G(N)$, where $\tilde{K} \leq \text{Aut}(N)$; see the proof of Theorem 2.2. Hence, $\tilde{K}/\text{Inn}(N) \cong K/NC_G(N)$ holds.

(\Rightarrow): Suppose K is a (P)-group. Then K/N is a (P)-group; thus, 4) has been proved. Also, as K is a (P)-group with normal subgroups N and $C_G(N)$ satisfying $N \cap C_G(N) = \{1\}$, it follows from (2.1) Lemma that all elements of order t^a ($a \geq 1$ odd) for a given prime t contained in $NC_G(N)$ must be contained in precisely one of the groups N or $C_G(N)$. Hence, 3) is fulfilled. Next, consider the (P)-group $K/C_G(N)$ for each of the groups $NC_G(N)/C_G(N) \cong \text{PSL}(2, p^n)$ (p odd prime, $n \geq 1$ odd); $NC_G(N)/C_G(N) \cong \text{PSL}(2, 2^a)$ ($a \geq 2$); $NC_G(N)/C_G(N) \cong \text{Sz}(2^{2t+1})$ ($t \geq 1$). Note that in these cases, $\text{Out}(\text{PSL}(2, p^n))$ is cyclic of order $2n$ and that $\text{Aut}(\text{PSL}(2, p^n))$ splits over $\text{Out}(\text{PSL}(2, p^n))$ if n is odd; that $\text{Out}(\text{PSL}(2, 2^a))$ is cyclic of order a and that $\text{Aut}(\text{PSL}(2, 2^a))$ splits over $\text{Inn}(\text{PSL}(2, 2^a))$; and finally that $\text{Out}(\text{Sz}(2^{2c+1}))$ is cyclic of order $2c + 1$ and that $\text{Aut}(\text{Sz}(2^{2c+1}))$ splits over $\text{Inn}(\text{Sz}(2^{2c+1}))$. These properties pave the way to the assertions as described in 1) and 2). Namely, the order of the (P)-group $K/NC_G(N)$ with $N \cong \text{PSL}(2, p^n)$ (p odd prime, $n \geq 1$ odd) divides $|\text{Out}(\text{PSL}(2, p^n))|$, but also $NC_G(N)\langle\alpha\rangle = K$ holds with $\langle\alpha\rangle N/N \cap NC_G(N)/N = 1$, where α induces a field automorphism of $\text{PSL}(2, p^n)$ (n odd) of order n . Hence, as $K/NC_G(N)$ is a (P)-group, $|\langle\alpha\rangle|$ has to satisfy $|\langle\alpha\rangle| \mid n$ and $(|\langle\alpha\rangle|, |\text{PSL}(2, p^n)|) = 1$ by the splitting property of $\text{Aut}(\text{PSL}(2, p^n))$ over $\text{Inn}(\text{PSL}(2, p^n))$ for n odd. Similar argument holds for the two cases $\text{PSL}(2, 2^a)$ ($a \geq 2$) and $\text{Sz}(2^{2c+1})$ ($c \geq 1$). In passing, the fact that K is supposed to be a (P)-group, plays a role in the assertion “ $(|\langle\alpha\rangle|, |N|) = 1$ ” mentioned above.

The proof of the direction (\Rightarrow) is complete.

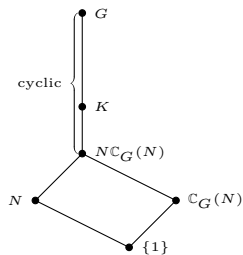

(\Leftarrow): Conversely, suppose the four conditions 1), 2), 3), and 4) are in vogue for a group G . Given is now that K/N is a (P)-group. Thus, it is enough to show that $K/C_G(N)$ is a (P)-group, see ([14], (2.8) Theorem), as $(|N|, |C_G(N)|) = 1$ has been assumed. Any group in the classes a), b), and c) is a (P)-group; see Theorem 5.1. Notice that here $(|K/N|, |N|) = 1$ holds by 1), 3) and the simplicity of N . The group $G/C_G(N)$ is cyclic for all the N from a), b) and c); see also the overview in the beginning of the proof of the \Rightarrow -part of the Theorem.

Therefore, by the Schur-Zassenhaus Theorem, there exists $U \leq K$ with U isomorphic to K/N satisfying $U \geq C_G(N)$ and with $K/NC_G(N)$ being cyclic, it follows that $K/C_G(N)$ being of order $|NC_G(N)/N| \cdot |U/C_G(N)|$, is a (P)-group, as the given N 's are (P)-groups and as all cyclic subgroups of $K/C_G(N)$ of order $|U|$ are conjugate to each other. Notice the full strength of the Schur-Zassenhaus Theorem here. [As to on the details here, view the proof of the next Corollary 5.3].

The proof of the \Leftarrow -part is complete.

The proof of the theorem has been done. □

Corollary 5.3 *Suppose G is a group containing one of the groups N mentioned in the hypothesis of Theorem 5.2 as a normal (nonabelian simple) group. Then G is a (P)-group if and only if $G = NR$ where $R \leq G$ is a solvable (P)-group whose order is relatively prime to the order of N .*

Proof (\Rightarrow): Let G be a (P)-group. In the proof of Theorem 5.2 (with G in the role of K there), we have got that in this situation, $|N|$ is relatively prime to $|\mathbb{C}_G(N)|$ whence $|N|$ is relatively prime to $|N\mathbb{C}_G(N)/N|$. In addition, $|G/N\mathbb{C}_G(N)|$ turned out to be relatively prime to $|N\mathbb{C}_G(N)/\mathbb{C}_G(N)|$, whence to $|N|$ (remember $N \cap \mathbb{C}_G(N) = \{1\}$). It follows that $|G/N|$ is relatively prime to $|N|$. Thus, by the Schur-Zassenhaus Theorem there exists $R \leq G$ with $G = NR$ and $R \cap N = \{1\}$. Notice that R is a (P)-group itself, as the group G/N , which is being isomorphic to R , is a (P)-group. Any complement of N in G is solvable by the Feit–Thompson theorem as $2 \mid |N|$, whence $2 \nmid |G/N|$.

(\Leftarrow): Conversely, let $G = NR$ with $N \trianglelefteq G$, $R \leq G$, $R \cap N = \{1\}$ and N as assumed in the assumptions of Theorem 5.2. Hence, N is a (P)-group itself, as we know now. Suppose $R \leq G$ is a (P)-group itself satisfying $(|N|, |R|) = 1$. Thus, R is solvable by the Feit–Thompson theorem. Let C_{p^a} and $\overline{C_{p^a}}$ be the cyclic subgroups of G of equal order p^a , where p is a prime and $a \geq 1$. If $p \nmid |N|$ we are done, as C_{p^a} and $\overline{C_{p^a}}$ are contained in the Sylow p -subgroups of G , S_p and $\overline{S_p}$ (say), but notice that none of $S_p, \overline{S_p}$ are normal in N when $p \mid |N|$. Indeed, there exists $n \in N$ with $(C_{p^a})^n = \overline{C_{p^a}}$, i.e. $\overline{C_{p^a}}$ and C_{p^a} are conjugate in N , whence they are conjugate in G . Next assume $p \nmid |N|$ and $p \mid |G|$. Hence, $p \mid |R|$. Now $C_{p^a} \leq \tilde{S}_p \in \text{Syl}_p(G)$ and $\tilde{C}_{p^a} \leq \tilde{S}_p \in \tilde{\text{Syl}}_p(G)$ for certain Sylow p -subgroups S_p and \tilde{S}_p of order p^a . There exists a Sylow p -subgroup $\overline{S_p}$ say of R which is also a Sylow p -subgroup of G . As the groups S_p, \tilde{S}_p , and $\overline{S_p}$ are conjugate to each other in G , one finds $(C_{p^a})^g \in \tilde{S}_p^g = \overline{S_p}$ for a suitable $g \in G$ and $(\tilde{C}_{p^a})^h \in \tilde{S}_p^h = \overline{S_p}$ for a suitable $h \in G$. Thus, $(C_{p^a})^g$ and $(\tilde{C}_{p^a})^h$ are cyclic groups both contained in $\overline{S_p}$ with $\overline{S_p} \leq R$ and with $|(C_{p^a})^g| = |(\tilde{C}_{p^a})^h| = |C_{p^a}| = |\tilde{C}_{p^a}| = p^a$. Since R is a (P)-group by assumption, there exists $t \in R$ with $((C_{p^a})^g)^t = (\tilde{C}_{p^a})^h$. It follows that $((C_{p^a})^g)^{th^{-1}} = \tilde{C}_{p^a}$, whence C_{p^a} and \tilde{C}_{p^a} do satisfy $(C_{p^a})^{gth^{-1}} = \tilde{C}_{p^a}$. Therefore, G is a (P)-group. \square

The structure of the groups appearing in Theorem 5.2 and Corollary 5.3 can be refined, due to the classification of the solvable (P)-groups as described in ([14], (4.4) Theorem), as follows.

Theorem 5.4 *Let G be a group as discussed in Theorem 5.2 and Corollary 5.3. Then it holds that G is a (P)-group if and only if*

$G = NR$ in which the (P)-group R equals SU satisfying $G = (N \times S) \rtimes U$, where $N \times S \trianglelefteq G$, $[N, S] = \{1\}$, $S \trianglelefteq R$, $(|N|, |S|) = 1$, S being the (possible empty) direct product of elementary abelian noncyclic Sylow p_i -subgroups of R for primes p_i ($i = 1, \dots, t$), whereas U is a metacyclic subgroup of R whose order is relatively prime to $|N \times S|$. In addition, $[N, [R, R]] = \{1\}$ holds, U acts, possibly nonfaithfully, on N by means of a (possibly trivial) field automorphism; $U/[U, U]$ and $[U, U]$ are cyclic and of orders relatively prime to each other.

Proof View the contents and the proofs of Theorem 5.2, Theorem 5.3 and ([14], (4.4) Theorem). \square

In the rest of this paper, it is of importance to take advantage of the Schur multiplier $\mathcal{M}(S)$, where

- 1) $S \in \{M_{11}; M_{23}; J_1; \text{PSL}(2, 2^a)(a \geq 3); \text{Sz}(2^{2t+1})(t \geq 2)\}$,
- 2) $S \cong \text{Sz}(8)$,
- 3) $S \in \{\text{PSL}(2, p^m)(p \text{ odd prime}, m \text{ odd}, p^m \geq 5)\}$.

It is a fact (see [11], 2.1.7 Theorem) that in case 1) any S has a trivial Schur multiplier, that in case 2) $\mathcal{M}(\text{Sz}(8)) \cong C_2 \times C_2$, and that in case 3) the Schur multiplier of S is isomorphic to C_2 . Notice $\text{PSL}(2, 4) \cong \text{PSL}(2, 5) \cong A_5$.

As such, one gets the following theorem.

Theorem 5.5 *Let S be a nonabelian group isomorphic to a chief factor of a (P)-group G . Suppose also that S has trivial Schur multiplier. Then $G = NR$, where $N \trianglelefteq G$, $N \cong S$, N is a (P)-group, R is a (P)-group, $R \leq G$, $(|N|, |R|) = 1$. [The more detailed structure of such a (P)-group G is analogous to the one described in Theorems 4.2 and 5.4].*

Proof The theorem holds in each of the cases S , where S stands for each one of the groups M_{11} , M_{23} , and J_1 ; see Theorem 4.2 and its proof. Thus, those cases have already been dealt with.

In Theorem 2.3, it has been shown that any nonsolvable (P)-group G satisfies an arbitrary series of the form $G \geq L > K \geq \{1\}$, where $L \trianglelefteq G$ and G/L solvable, $K \trianglelefteq G$ and L/K simple and nonabelian. Let M be a minimal normal subgroup of G contained in K [the case $K = M = \{1\}$ is dealt with in Theorem 5.1]. Thus, assume indeed that $M \neq \{1\}$. Since G/M is a (P)-group, by induction via the Jordan–Hölder theorem, we may assume that the theorem holds for G/M . In other words, we may assume $K = M \neq \{1\}$. We distinguish two cases: α) $K = \zeta(L)$, β) $K \neq \zeta(L)$.

Re α) Assume $K = \zeta(L)$. Here we have $L = L'\zeta(L)$ as $L/\zeta(L) = (L/\zeta(L))' = L'\zeta(L)/\zeta(L)$. Due to a theorem of Schur ([11], 2.1.7 Theorem), $L' \cap \zeta(L)$ is isomorphic to a subgroup of the Schur multiplier of $L/\zeta(L)$. By assumption here, that multiplier is trivial, so $L' \cap \zeta(L) = \{1\}$, i.e. L is the direct product of L' and $\zeta(L)$. Next, note that $L' \trianglelefteq G$ and $\zeta(L) \trianglelefteq G$, whence G/L' and $G/\zeta(L)$ are both (P)-groups, G is a (P)-group. Hence, it follows that $(|L'|, |\zeta(L)|) = 1$ by the (P)-property of G . Observe that $L' \cong L'/(L' \cap \zeta(L)) \cong L'\zeta(L)/\zeta(L) = (L/\zeta(L))'$, so that L' is a simple nonabelian minimal normal subgroup of G , isomorphic to L/K . Hence, the statement of the theorem holds with L' playing the role of N .

Re β) Assume $K \neq \zeta(L)$. Consider $G/\mathbb{C}_G(K)$. Notice that $\mathbb{C}_G(K) \geq K$, as K is an elementary abelian p -group for some suitable prime number p ; here the possibility $K \cong C_p$ is not excluded too. If $G/\mathbb{C}_G(K)$ happens to be solvable, then we are back in case α). [Indeed, by induction there exists a chief section \tilde{L}/K of G with $\tilde{L} \leq \mathbb{C}_G(K)$ and note that $\tilde{L}/K \cong L/K$ by Theorem 2.3.] Thus, we assume that the (P)-group $G/\mathbb{C}_G(K)$ is not solvable, and by induction it contains a normal simple nonabelian subgroup isomorphic to S , so K is elementary abelian but not cyclic of prime power order. Suppose $K = C_p \times C_p \times \cdots \times C_p$, $n \geq 2$ times. Since G is a (P)-group, the group $G/\mathbb{C}_G(K)$, regarded as a subgroup of $\text{Aut}(K)$, acts like a subgroup \overline{G} (say) of $\text{GL}(n, p)$ on the vector space \mathbb{F}_p^n , thereby permuting transitively the lines of \mathbb{F}_p^n as G is a (P)-group. Let us look at the group $\overline{G}\zeta(\text{GL}(n, p))$ and call that the latter group $\overline{\overline{G}}$. The group $\overline{\overline{G}}$ permutes transitively the elements of order p of \mathbb{F}_p^n , and is isomorphic to such a group transitively permuting the nontrivial elements of K . One has now arrived in a situation where Hering's theorem may be applied. A necessary remark here is that none of the groups $\text{PSL}(2, 2^a)$ ($a \geq 3$) is isomorphic to some $\text{PSL}(2, p^m)$ for an odd prime p and $m \geq 1$; see Artin's result in ([1], Theorem 2, page 466). It follows from the list in Hering's theorem that, in order to investigate (P)-groups admitting a chief factor of the

shape $SL(2, 2^a)$ ($a \geq 3$) and $Sz(2^{2t+1})$ ($t \geq 2$), only the first two cases of the nine possibilities must be investigated further. That is, here one has $p = 2$ and also $SL(2, 2^a)$ ($a \geq 3$) might occur perhaps as a possibility for an isomorphic simple normal subgroup $\bar{S}/\mathbb{F}(G)$ of the group $\bar{G} = G/\mathbb{F}(G)$, where G is a (P)-group too. It is allowed now here, to assume that $C_G(K) = K$ by induction; the argumentation is left to the reader. Thus, as G is a (P)-group, $|G : N_G(C_p)| = |\mathbb{F}(G) \setminus \{1\}| = 2^{2a} - 1$; see Hering's theorem, where C_2 is a subgroup of $\mathbb{F}(G)$ of order 2.

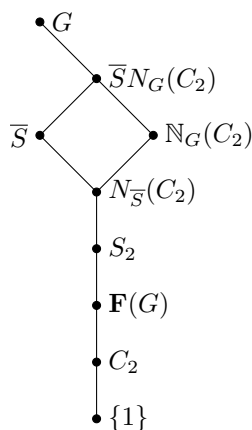

Let $S_2 \in Syl_2(\bar{S})$ such that $C_2 \leq \zeta(S_2)$. Notice that there exists $x \in \bar{S}$ of order 3 in \bar{S} not centralizing each involution of the elementary abelian 2-group $\mathbb{F}(G) = C_G(K) = K$; otherwise, $\bar{S}/\mathbb{F}(G)$ would not be simple. Suppose a fortiori that $[C_2, \langle x, \rangle] = \{1\}$. Even stronger, $2^{2a} - 1$ divides $|\bar{S} : S_2|$. It holds now here that $(|\bar{S}/\mathbb{F}(G)|, |G/\bar{S}|) = 1$, see Theorem 5.4 applied in the (P)-group $G/\mathbb{F}(G)$. Hence, as $|G : \bar{S}N_G(C_2)|$ divides $|G : N_G(C_2)|$ and also $|\bar{S} : S_2|$, it follows that $|G : \bar{S}N_G(C_2)| = 1$: Therefore, $N_G(C_2) = S_2$. Hence, it follows that x does not centralize any nontrivial element from $\mathbb{F}(G)$.

Therefore, if $t \in \mathbb{F}(G) \setminus \{1\}$, the set $\{1, t, t^x, t^{(x^2)}\}$ constitutes a Klein 4-group which is x -invariant. There exists a 2-element b in S outside $\mathbb{F}(G)$ with $b^2 \in \mathbb{F}(G)$ such that $b\mathbb{F}(G)$ inverts $x\mathbb{F}(G)$ under conjugation in the group $(S/\mathbb{F}(G))'$, notice $S_2/\mathbb{F}(G)$ is an elementary abelian 2-group [In fact, each 2-element of S outside $\mathbb{F}(G)$ has order 4, as G is a (P)-group]. Now as $(b^2)^b = b^2$, $((b^2)^x)^b = ((b^2)^b)^{x^{-1}} = (b^2)^{x^{-1}} = (b^2)^{(x^2)}$ and $((b^2)^{(x^{-1})})^b = ((b^2)^b)^{(x^2)^{-1}} = b^2$ one observes that the Klein 4-group $\langle b^2, (b^2)^x \rangle$ is a normal subgroup of $\langle x, b \rangle$. Next, observe that $\langle x, b \rangle / \langle b^2, (b^2)^x \rangle$ is isomorphic to S_3 , the symmetric group on three symbols. As we saw earlier, $\langle b^2, (b^2)^x \rangle$ is contained in the commutator subgroup of $\langle x, b \rangle$ as x permutes the three nontrivial elements of $\langle b^2, (b^2)^x \rangle$ under conjugation. Hence, one gets in all $3 = |(\langle x, b \rangle / \langle b^2, (b^2)^x \rangle)'| = |\langle x, b \rangle' / (\langle x, b \rangle' \cap \langle b^2, (b^2)^x \rangle)| = |\langle x, b \rangle' / \langle b^2, (b^2)^x \rangle|$. It yields $|\langle x, b \rangle / \langle x, b \rangle'| = 2$ with $|\langle x, b \rangle| = 24$. It is a classical fact that any group of order 24 whose commutator subgroup has index 2 in that group turns out to be isomorphic to the symmetric group S_4 on four symbols. Thus, $\langle x, b \rangle \cong S_4$. Hence, there exists an involution d in $\langle x, b \rangle$ with $d \notin \langle (b^2)^x, b^2 \rangle$. Since $\langle (b^2)^x, b^2 \rangle \trianglelefteq \langle x, b, d \rangle$, the group $\langle (b^2)^x, b^2, d \rangle$ is isomorphic to a dihedral Sylow 2-subgroup of order 8 of S_4 . Thus, $d \notin \mathbb{F}(G)$, as $\mathbb{F}(G)$ is an elementary abelian 2-group. Therefore, the possibilities (1) and (2) in Hering's theorem do not occur for a (P)-group G here in this theorem. To close with, the case when $|\mathbb{F}(G)|$ is prime, has already been dealt with. In summary, there exists indeed a simple $N \trianglelefteq G$ with $N \cong \{M_{11}, M_{23}, J_1, SL(2, 2^a)(a \geq 3); Sz(2^{2t+1})(t \geq 2)\}$. The further assertions in the theorem are clear from Theorem 5.2, Corollary 5.3, and Theorem 5.4.

The theorem has been proved. □

In Theorem 5.5, we dealt with the groups $Sz(2^{2t+1})$ ($t \geq 2$) but the group $Sz(2^3)$ was purposely left out. Notice, each of all Suzuki simple groups is a (P)-group itself. The Schur multiplier of $Sz(2^3)$ is isomorphic to

$C_2 \times C_2$; see ([11], 7.4.2 Theorem). Despite that “anomaly”, the following theorem still holds.

Theorem 5.6 *Suppose $Sz(2^3)$ is isomorphic to a chief factor of a (P)-group G . Then $G = NR$, where $N \trianglelefteq G$, $N \cong Sz(2^3)$, $R \leq G$, R is a (possibly trivial) (P)-group satisfying $(|N|, |R|) = 1$. The structure of R can be read off from Theorem 5.2, Corollary 5.3, Theorem 5.4, and Theorem 5.5.*

Proof We follow the proof of Theorem 5.5 up to the point where $G \geq L > K \geq \{1\}$ has been reached, where K is a minimal normal and elementary abelian subgroup of G with L/K a chief factor of G with $L/K \cong Sz(2^3)$ and G/L solvable. Then one splits up the proof into: α) $K \neq \zeta(L)$ and β) $K = \zeta(L)$.

Re α) The arguments like the ones used in Re β) in the proof of Theorem 5.5 yield that one approaches one of the nine possibilities set out in Hering’s Theorem, or that $|K| = p$ for some prime p . Here, nevertheless, in none of the nine cases, the group $Sz(2^3)$ is involved as a possibility for a chief factor of $G/\mathbb{C}_G(K)$. Thus, case α) does not occur unless $|K| = p$, and this case will be treated in the next case Re β).

Re β) Let us assume $K = \zeta(L)$. Hence, we have $L = L'\zeta(L)$, as $L/\zeta(L)$ is a nonabelian simple group equal to its commutator subgroup $(L/\zeta(L))'$, whence equal to $L'\zeta(L)/\zeta(L)$. Due to Schur ([11], 2.1.7 Theorem), the group $L' \cap \zeta(L)$ is isomorphic to a subgroup of $C_2 \times C_2$, because the Schur multiplier of $Sz(2^3)$, regarded as isomorphic to $L/\zeta(L)$, is isomorphic to $C_2 \times C_2$. The group $L' \cap \zeta(L)$, being characteristic in L , is normal in G . Thus, as G is a (P)-group and K a minimal and elementary abelian subgroup of G ($|K|$ could be a prime number), one gets that $L' \cap \zeta(L) = \{1\}$ or that $L' \cap \zeta(L) = K$. In case $L' \cap \zeta(L) = \{1\}$, it follows along similar lines as in the proof of α) in Theorem 5.5 that there exists $N \trianglelefteq G$ satisfying $N \cong Sz(2^3)$. The truth of the assertion of the theorem follows directly from it. Thus, let us proceed with $L' \cap \zeta(L) = K = \zeta(L) \neq \{1\}$. Here two cases must be considered, namely $|K| = 2$ and $\zeta(L) = K \cong C_2 \times C_2$.

Let us assume $|K| = 2$. Now, as G is a (P)-group and not solvable, it follows that a Sylow 2-subgroup of G is generalized quaternion; see ([8], III. 8.2.b Satz). It holds that $\text{Aut}(Sz(2^3))$ is isomorphic to $\text{Inn}(Sz(2^3)) \rtimes \langle \Theta \rangle$, a split extension with a field automorphism Θ of order 3. By induction, the (P)-group G/K has the property that $(|G/L|, |L/K|) = 1$, so any Sylow 2-subgroup of G is also a Sylow 2-subgroup of L . Let $P \in \text{Syl}_2(L)$. The order of $Sz(2^3)$ is $2^6 \cdot 5 \cdot 7 \cdot 13$; see ([6], page 28). According to ([6], page 8), the commutator subgroup of P/K is at least of index 8 in P/K . On the other hand, as P is here generalized quaternion, either P/K is nonabelian or $P/K \cong C_2 \times C_2$. In both these cases, one has $|(P/K)/(P/K)'| = 4$, contrary to the just mentioned bound $8 \mid |(P/K)/(P/K)'|$.

Hence, $|K| \neq 2$. There remains $L' \cap \zeta(L) = K = \zeta(L) \cong C_2 \times C_2$ to be considered.

Therefore, inside such a group L , there exists now a subgroup U of order $2^8 \cdot 7$ normalizing a Sylow 2-subgroup V (say) of L and containing K . Since G is a (P)-group with $K \trianglelefteq G$, the only involutions in G are those from $K \setminus \{1\}$. According to ([6]), U is a maximal subgroup of L . As it holds that $\mathbb{N}_L(V)/\mathbb{C}_L(V)$ embeds in $\text{Aut}(V)$ as a subgroup, it becomes of interest what the structure of $\text{Aut}(V)$ looks like. It is a surprising fact that $7 \nmid |\text{Aut}(V)|$ holds, just by the fact that V contains precisely three involutions of G ; see ([4], Volume 3, page 394, Exercise 3), using the contents of §82 in ([4]). This implies that $|\mathbb{N}_L(V) : \mathbb{C}_L(V)|$ is a power of 2. Hence, $\mathbb{C}_L(V)$ contains an element of order 7, centralizing V .

This is a contradiction to the actual structure of U as can be read off in ([6], page 8). Therefore, there exists $N \trianglelefteq G$ with $N \cong \text{Sz}(2^3)$ yielding all the statements of the theorem, as argued in Theorems 5.2 and Theorems 5.4.

The theorem has been proved. □

Next, as a useful intermezzo on its own account, let us assume that some (P)-group G does contain a Sylow p -subgroup of S for some odd prime p , whose intersection with the Fitting subgroup $\mathbb{F}(G)$ of G is not trivial. Then, as it will be shown implicitly in the next theorem, it follows that either S is cyclic or else that S is elementary abelian but not cyclic; in the last case at least, the group S is a normal subgroup of G . Indeed, if $S \cap \mathbb{F}(G)$ is cyclic and not trivial, $\mathbb{F}(G)$ does contain a unique normal subgroup U (say) of order p that happens to be normal in G too. Thus, as G is a (P)-group, it follows that G contains precisely one subgroup of order p . Hence, by ([8], III. 8.2 Satz) S itself is cyclic due to p being odd. We are left to prove the following theorem thereby.

Theorem 5.7 *Let G be a (P)-group and assume that for some odd prime p , its Fitting subgroup $\mathbb{F}(G)$ contains a noncyclic p -subgroup. Then the (normal) Sylow p -subgroup S of $\mathbb{F}(G)$ is a (in fact the) normal Sylow p -subgroup of G ; moreover S is elementary abelian.*

Proof The proof is given by means of a series of steps.

1) Suppose $O_{p'}(\mathbb{F}(G)) \neq \{1\}$. The group $G/O_{p'}(\mathbb{F}(G))$ is a (P)-group, so by induction $G/O_{p'}(G)$ does contain a normal and elementary abelian but noncyclic Sylow p -subgroup which is $\overline{S}O_{p'}(G)/O_{p'}(G)$ for some $\overline{S} \in \text{Syl}_p(G)$. Hence, \overline{S} is elementary abelian and noncyclic. Therefore, as $\{1\} < \overline{S} \cap \mathbb{F}(G) \leq \overline{S}$, and as G is a (P)-group, $\overline{S} \leq \mathbb{F}(G)$ does follow, whence $\{\overline{S}\} = \text{Syl}_p(G)$ happens to be true.

2) Thus, let $O_{p'}(\mathbb{F}(G)) = \{1\}$, i.e. $\mathbb{F}(G)$ is a noncyclic (P)-group. The elementary abelian group $\mathbb{F}(G)/\Phi(\mathbb{F}(G))$ is not cyclic; for otherwise $\mathbb{F}(G)$ would be a cyclic p -group due to Burnside's Basis Theorem ([8], III. 3.15 Satz) which does not happen in this case. The group $G/\Phi(\mathbb{F}(G))$ is a (P)-group. Hence, in case $\Phi(\mathbb{F}(G)) \neq \{1\}$, $\mathbb{F}(G)/\Phi(G)$, being equal to $\mathbb{F}(G)/\Phi(G)$ by ([8], 4.2. d) Satz), does contain a noncyclic Sylow p -subgroup, whence by induction $G/\Phi(\mathbb{F}(G))$ possesses a normal elementary abelian Sylow p -subgroup $U/\Phi(\mathbb{F}(G))$ (say), so $U \geq \mathbb{F}(G)$, whence U is a nilpotent and normal p -subgroup of G yielding $U = \mathbb{F}(G) \in \text{Syl}_p(G)$. Thus, $p \nmid |G/\mathbb{F}(G)|$ and so by Shult ([9], VIII. 7.11.a Remarks), $\mathbb{F}(G)$ is homocyclic abelian; here it is used that G is a (P)-group, that $G/\mathcal{C}_G(\mathbb{F}(G))$ is a (P)-group and that $G/\mathcal{C}_G(\mathbb{F}(G)) \hookrightarrow \text{Aut}(\mathbb{F}(G))$ with $\{\mathbb{F}(G)\} = \text{Syl}_p(G)$ permutes the cyclic p -subgroups of G transitively under conjugation. Subsequently it follows from ([9], VIII. 5.8.b Theorem) and ([14] Theorem C), that $\mathbb{F}(G)$ is elementary abelian anyway. Therefore, it is allowed to proceed with the following step.

2)a) Assume $\mathbb{F}(G)$ is elementary abelian and noncyclic p -group. We distinguish two cases: $\alpha) \mathbb{E}(G) \neq \{1\}$;
 $\beta) \mathbb{E}(G) = \{1\}$

2)a) α) Assume $\mathbb{E}(G) \neq \{1\}$. Then it follows that the p -group $\mathbb{E}(G) \cap \mathbb{F}(G)$ is trivial. [Indeed, $\mathbb{E}(G)$ is a nonabelian simple group here, as we know that $\mathbb{E}(G)\zeta(\mathbb{E}(G)) \neq \{1\}$ is simple for a (P)-group G and that $\zeta(\mathbb{E}(G))$ is a nilpotent (possibly trivial) 2-subgroup of G ; see ([11], 2.1.7 Theorem) and remember that

the Schur multiplier of such a simple group $\mathbb{E}(G)/\zeta(\mathbb{E}(G))$ is a (possibly trivial) 2-group.] The groups $\mathbb{F}(G)$ and $\mathbb{E}(G)$ do centralize each other, by ([2], 11 (31.12)). The (P)-group $G/\mathbb{E}(G)$ is solvable by Theorem 2.3, whence by ([14], (4.4) Theorem), $G/\mathbb{E}(G)$ contains now a normal Sylow p -subgroup \bar{S} , as $\mathbb{F}(G/\mathbb{E}(G))$, containing $\mathbb{F}(G)\mathbb{E}(G)/\mathbb{E}(G)$ as a noncyclic p -group. Hence, in addition, by ([14] Theorem C), \bar{S} is elementary abelian. It follows that $\{\mathbb{F}(G)\} = \text{Syl}_p(G)$ by the (P)-property of G in combination with the fact that $\mathbb{E}(G) \cap \mathbb{F}(G) = \{1\}$ and $[\mathbb{E}(G), \mathbb{F}(G)] = \{1\}$.

2)a) β) Let us finally assume that $\mathbb{F}(G)$ is elementary abelian noncyclic and that $\mathbb{E}(G) = \{1\}$. Hence, $\mathbb{C}(\mathbb{F}(G)) = \mathbb{F}(G)$. [Indeed, once again this fact stems from the important general theorem ([10], X. 13.12 Theorem) asserting that $\mathbb{C}_G(\mathbb{F}^*(G)) \leq \mathbb{F}^*(G)$, $\mathbb{F}(G)$ being abelian, it follows that indeed $\mathbb{C}_G(\mathbb{F}^*(G)) = \mathbb{F}^*(G)$ as $\mathbb{F}^*(G) = \mathbb{F}(G)$]. Therefore, one can regard $\mathbb{F}(G)$ as being an additive subgroup of the vector space $\mathbb{F}_{p^n}^+$ over \mathbb{F}_p , so that $G/\mathbb{F}(G)$ acts like a subgroup \bar{G} of $\text{GL}(n, p)$ with $\bar{G} \cong G/\mathbb{F}(G)$ permuting the lines of $\mathbb{F}_{p^n}^+$ transitively. Now let us follow the lines of Hering's theorem. One comes across nine structures of groups.

The cases 3), 6), 7), and 9) have to do with $p = 2$, contrary to the assumption on p being an odd prime. In case 4), it follows implicitly that there exists a unique element of order 2 in \bar{G} , due to the fact that \bar{G} is a (P)-group such that also $\bar{G}\zeta(\text{GL}(n, p)) < \text{GL}(n, p)$ contains an extra-special normal subgroup of order 2^{2t+1} , say. Hence, indeed $t = 1$ must hold. The structure of \bar{G} in this case yields the solvability of \bar{G} , so that the theorem holds due to ([14], (4.4) Theorem) for the (now solvable) (P)-group G .

In cases 1) and 2) considered together, we see that either \bar{G} is a solvable (P)-group in which situation we are done by Sezer's theorem ([14], (4.4) Theorem) or that \bar{G} contains a now solvable normal subgroup M isomorphic to some $\text{SL}(r, p^t)$. On the other hand, \bar{G} is a (P)-group too, so that here $r = 2$ must hold, due to Theorem 5.2, Theorem 5.3, and Corollary 5.4. By these very theorems and corollary, p does not divide $|\bar{G}/M|$. Here the question does occur whether G is a (P)-group after all in such a case 1) or 2). It happens that such a G is not a (P)-group; see the end of the proof of Theorem 6.1, being independent of this result.

Thus, let us investigate case 5). Here the last term in the derived series of \bar{G} isomorphic to $\text{SL}(2, 5)$. Let us first consider the alleged possibility $|\mathbb{F}(G)| = 3^4$ in this case. Notice that $|\text{GL}(4, 3)| = 2^9 \cdot 3^4 \cdot 5 \cdot 13$ and $|\text{SL}(2, 5)| = 2^3 \cdot 3 \cdot 5$. It holds by Theorem 5.3 that the (P)-group \bar{G} satisfies $(|\bar{G}/\bar{G}^\infty|, |\bar{G}^\infty|) = 1$. Hence, it follows that $3 \nmid |\bar{G}/\bar{G}^\infty|$ and that $|\bar{G}/\bar{G}^\infty|$ is odd and $5 \nmid |\bar{G}/\bar{G}^\infty|$. Thus, $|\bar{G}/\bar{G}^\infty|$ equals 1 or 13.

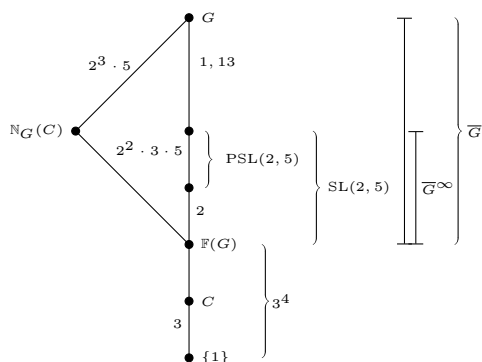

Let us focus our attention on some cyclic subgroup C of order 3 in $\mathbb{F}(G)$. The assumption that G is a (P)-group, yields $|G : \mathbb{N}_G(C)| = \frac{3^4-1}{2} = 40 = 2^3 \cdot 5$ as there are 40 subgroups of order 3 in $\mathbb{F}(G)$ all conjugate to each other in the (P)-group, so $|\mathbb{N}_G(C) : \mathbb{F}(G)|$ equals 3 or $3 \cdot 13$.

On the other hand, any involution of G acting on $\mathbb{F}(G)$ by conjugation normalizes one subgroup \tilde{C} of order 3 in $\mathbb{F}(G)$. By assumption of the (P)-property of G , $\mathbb{N}_G(C)$ and $\mathbb{N}_G(\tilde{C})$ must be conjugate to each other. Next, notice that $2 \mid |\mathbb{N}_G(\tilde{C})|$ but at the same time it was derived that 2 does not divide $|\mathbb{N}_G(C)| = |\mathbb{N}_G(C)/\mathbb{F}(G)||\mathbb{F}(G)|$. A contradiction, so case 5) with $|\mathbb{F}(G)| = 3^4$, does not occur. There remains to investigate in case 5): $|\mathbb{F}(G)| = p^2$ where now $p \in \{11, 19, 29, 59\}$. Hence, $|\text{GL}(2, p)|$ is equal to $2^4 \cdot 3 \cdot 5^2 \cdot 11$ or to $2^4 \cdot 3^4 \cdot 5 \cdot 19$ or to $2^5 \cdot 3 \cdot 5 \cdot 7^2 \cdot 29$ or to $2^4 \cdot 3 \cdot 5 \cdot 29^2 \cdot 59$, respectively. Let $U/\mathbb{F}(G)$ be the group \overline{G}^∞ with $U \leq G$, and $R/\mathbb{F}(G) := \zeta(U/\mathbb{F}(G))$ with $R \trianglelefteq G$. Since G/R is a (P)-group, it follows now from $\overline{G}^\infty \cong \text{SL}(2, 5)$ that G/R is a direct product of the groups U/R and H/R (say) with $H \trianglelefteq G$ satisfying $(|H/R|, |U/R|) = 1$.

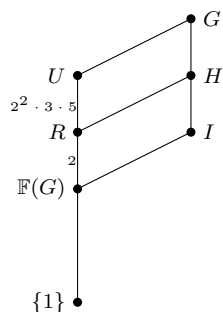

Therefore, $H/\mathbb{F}(G)$ itself, due to $2 \nmid |H/R|$, is also a direct product of the groups $R/\mathbb{F}(G)$ and $I/\mathbb{F}(G)$ (say) for some suitable $I \trianglelefteq G$. Notice $I/\mathbb{F}(G) \cong H/R$. Now notice that no nontrivial number $11v + 1$ does divide $2 \cdot 5$ likewise no nontrivial number $29v + 1$ divides $2^2 \cdot 7^2$ and likewise no nontrivial number $59v + 1$ divides $2 \cdot 29^2$. Otherwise said, for any of the four choices of p , it happens that G/U contains a normal Sylow p -subgroup due to Sylow's Theorem.

Hence, a Sylow p -subgroup S_p of G must be normal in G itself, being of order p^3 or p^2 , since $G/U \cong H/R \cong I/\mathbb{F}(G)$; remember, $G/\mathbb{F}(G)$ is isomorphic to a direct product of $I/\mathbb{F}(G)$ and $U/\mathbb{F}(G)$. Suppose $|S_p| = p^3$. The group $\Phi(S_p)$ is normal in G and it has order p^2 or p or 1. If $|\Phi(S_p)| = p^2$ would hold, then S_p would be cyclic, which is not the case. If $|\Phi(S_p)| = p$ would hold, then, by the normality of $\Phi(S_p)$ in G , a contradiction to the (P)-property of G would have been obtained, since $\mathbb{F}(G)$ is a minimal normal subgroup of G . If $\Phi(S_p) = \{1\}$ would hold, then S_p would be elementary abelian a contradiction to the (P)-property of G when looking at the elementary abelian subgroup $\mathbb{F}(G)$ of G . In summary, one must have here, that $\{\mathbb{F}(G)\} = \text{Syl}_p(G)$. As it will be shown later, there exist indeed (P)-groups G satisfying $p \nmid |G/\mathbb{F}(G)|$ and $|\mathbb{F}(G)| = p^2$ with p being equal to 11, or 19, or 29, or 59.

Thus, there remains case 8) to investigate, in which $\overline{G}\zeta(\text{GL}(6, 3)) \cong \text{SL}(2, 13)$ with $|\mathbb{F}(G)| = 3^6$. As it happens, all the maximal subgroups of $\text{SL}(2, 13)$ are solvable. Now, if the (P)-group G is solvable itself in case 8) we are immediately done by Sezer's theorem yielding

$\{\mathbb{F}(G)\} = \text{Syl}_3(G)$. Thus, we may work with the assumption that $\overline{G} = G/\mathbb{F}(G) \cong \text{SL}(2, 13)$. Let us assume for the moment that an involution τ of G acts by conjugation on the elementary abelian group $\mathbb{F}(G)$ of order 3^6 in such a way that τ acts trivially on some specific subgroup C of $\mathbb{F}(G)$ of order 3. Next notice that all the involutions of G are of the form τf for some $f \in \mathbb{F}(G)$, due to $\overline{G} \cong \text{SL}(2, 13)$. Since G is a (P)-group, all subgroups of order 3 are conjugate to each other; they are all contained in $\mathbb{F}(G)$. Hence, considering $C = \langle c \rangle$ with $c \in G$, one gets $(c^g)^{g^{-1}\tau g} = (c^\tau)^g = c^g$, whereas $g^{-1}\tau g = \tau \tilde{f}$ for a suitable $\tilde{f} \in \mathbb{F}(G)$. It yields $(c^g)^{\tau \tilde{f}} = ((c^g)^\tau)^{\tilde{f}} = ((c^g)^\tau)$. Consequently though, τ works trivially on the whole group $\mathbb{F}(G)$, implying $\mathbb{F}(G)\langle \tau \rangle$ being nilpotent and normal in G ; a contradiction to the fact that $\mathbb{F}(G)$ is the Fitting subgroup of G . Therefore, τ acts on $\mathbb{F}(G)$ by inverting each element of $\mathbb{F}(G)$; the same property holds now for any involution of the (P)-group G . Next, observe that there exists $a \in G$ satisfying $a^6 \in \mathbb{F}(G)$ and also satisfying $|a\mathbb{F}(G)| = 6$. Now, if $|a| = 6$ would hold, then the order of a^2 is 3, whence $a^2 \in \mathbb{F}(G)$, a contradiction to the (P)-group property of G yielding $\{A \leq G \mid |A| = 3\} \subseteq \mathbb{F}(G)$, so $|a| = 18$ is forced. Hence, a^9 is an involution of G , centralizing the subgroup $\langle a^6 \rangle \in \mathbb{F}(G)$ of order 3. The assumption G being a (P)-group provides now the conflicting interests $\langle a^6 \rangle \in \mathbb{F}(G)$ and the involution a^9 acting on $\mathbb{F}(G)$ by inverting all the elements of $\mathbb{F}(G)$ as argued above. Therefore, case 8) does not occur.

The theorem has been proved. □

Let us see what happens if a (P)-group G does contain some noncyclic p -subgroup contained in $\mathbb{F}(G)$, where p is an odd prime. If so, then it was shown in Theorem 5.7 that G contains an elementary abelian p -subgroup P satisfying $P \trianglelefteq G$, $\{P\} = \text{Syl}_p(G)$ (whence $P \leq \mathbb{F}(G)$). Look at $\mathbb{C}_G(P)$. One has $P \leq \mathbb{C}_G(P)$ and, as $(|\mathbb{C}_G(P)/P|, |P|) = 1$, it holds that there exists $U \trianglelefteq G$ such that $U \cong \mathbb{C}_G(P)/P$. Notice $\mathbb{C}_G(P)/U \cong P$ and that apparently also $(|G/\mathbb{C}_G(P)|, |\mathbb{C}_G(P)/U|) = 1$ holds. Let $\overline{G} := G/U$ and $\overline{P} = \mathbb{C}_G(P)/U$. Hence, $\mathbb{C}_{\overline{G}}(\overline{P}) = \overline{P}$ does follow.

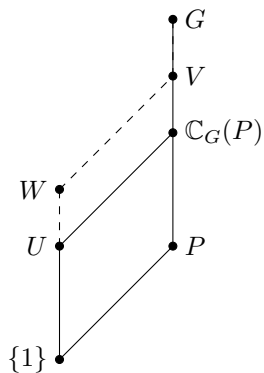

[Indeed, if $V/U := \mathbb{C}_{\overline{G}}(\overline{P})$ with $G \geq V \geq \mathbb{C}(P)$, then there would exist $W \trianglelefteq G$ with $W \geq U$, $p \nmid |W|$ and $W\mathbb{C}_G(P) = V$, and $W \cap \mathbb{C}_G(P) = U$ all this due to $(|V/\mathbb{C}_G(P)|, |\overline{P}|) = 1$. As $W \trianglelefteq G$ with $p \nmid |W|$, one gets that W centralizes the normal subgroup P of G , yielding though that W coincides U].

Next, let $|P| = p^n$, where $n \geq 2$ holds with P elementary abelian. Again, we are in the situation of Hering's theorem when $\overline{G} \leq \text{GL}(n, p)$ and $\overline{G} \cong \overline{G}/\overline{P}$ holds. Analyzing the nine possibilities in Hering's theorem one gets the following, after splitting up the discussion into \overline{G} not solvable and \overline{G} solvable, respectively.

- (a) Suppose that \overline{G} is not solvable. As above, $(|\overline{G}|, p) = 1$ holds here. Hence, out of the nine possible structures in Hering's theorem only the cases (4), (5) and (8) have to be investigated in respect to an eventual (P)-group \overline{G} and (P)-group \overline{G} . In case 4) only $n = 2$ might happen as $\overline{G}\zeta(\text{GL}(n, p)) \leq \text{GL}(n, p)$

possesses at most one involution in the (P)-group \overline{G} here, yielding indeed $n = 2$ with $|P| = p^2 \in \{3^2, 5^2, 7^2, 11^2, 23^2\}$. On the other hand, in case 4) this situation yields the solvability of \overline{G} too. Thus, case 4) does not occur here for a nonsolvable (P)-group \overline{G} . Let us consider case 5) for a nonsolvable (P)-group \overline{G} . Remember again that $p \nmid |\overline{G}|$. Hence, in case 5) one gets $\overline{G}/\overline{P} \supseteq R$ with $R \cong \text{SL}(2, 5)$ and $p^2 \in \{11^2, 19^2, 29^2, 59^2\}$. Now, if $p^2 = 11^2$, then it will turn out that $\overline{G}/\overline{P} \cong \text{SL}(2, 5)$. Also, if $p^2 = 19^2$, then $\overline{G}/\overline{P} \cong \text{SL}(2, 5)$ too. Moreover, if $p^2 = 29^2$, then $\overline{G}/\overline{P} \cong \text{SL}(2, 5)$ or $\overline{G}/\overline{P} \cong \text{SL}(2, 5) \times C_7$ (both are allowed). Finally, if $p^2 = 59^2$, then $\overline{G}/\overline{P} \cong \text{SL}(2, 5)$ or $\overline{G}/\overline{P} \cong \text{SL}(2, 5) \times C_{29}$ (both are allowed). At last, we have to consider case 8). One has $\overline{G}/\overline{P} \cong \text{SL}(2, 13)$ here and $|\overline{P}| = 3^6$. The nonsolvable group $\text{SL}(2, 13)$ has all its maximal subgroups solvable. Hence, in our part (a) under consideration, one has $\overline{G}/\overline{P} \cong \text{SL}(2, 13)$. Then, however, we are able to dismiss immediately case 8), as \overline{G} happens to be a (P)-group; see the end of the proof of Theorem 5.7. [Another feature happening in (a) is that even $(|\mathbb{C}_G(P)/P|, 30) = 1$ holds; see Theorem 6.1 later, being independent from this theorem].

(b) Suppose that \overline{G} is solvable. Then the structure of \overline{G} can be read off in Theorem A in [14], to which the reader is kindly referred.

Next, let us assume that a (P)-group G admits a chief factor isomorphic to $\text{PSL}(2, 5)$ and that $P \triangleleft G$ is an elementary abelian normal p -subgroup of order $p^2 \in \{11^2, 19^2, 29^2, 59^2\}$. Then it will turn out that $G/\mathbb{C}_G(P)$ is not solvable, whence that we are back in case (a) just considered above. Namely suppose, on the contrary that $G/\mathbb{C}_G(P)$ is solvable. [Notice also that $X \neq \mathbb{C}_X(Y)$ for any nontrivial (P)-group X with $Y \trianglelefteq X$ being some elementary abelian t -group (t prime)]. Remember $|\text{PSL}(2, 5)| = 2^2 \cdot 3 \cdot 5 = 60$. There exists now a chief factor L/K of G with $L/K \cong \text{PSL}(2, 5)$ and $L \trianglelefteq G$, $K \trianglelefteq G$, $P \leq K < L \leq \mathbb{C}_G(P)$. By assumption $G/\mathbb{C}_G(P)$ is not trivial here. Since G/K is a (P)-group, it follows that $(60, |G/L|) = (|L/K|, |G/L|) = 1$, due to Theorem 5.2. Therefore, $|G/L|$ is relatively prime to 15. Let $C_p < G$ be a cyclic group of order p , where $p \in \{11, 19, 29, 59\}$. Then, as G is a (P)-group with $\mathbb{C}_G(P) \geq L$, one has $|G : \mathbb{N}_G(C_p)| \in \{12, 20, 30, 60\}$ as inside G there are precisely $p + 1$ subgroups of order p , all being contained in P . Notice now that none of these numbers 12, 20, 30, and 60 are relatively prime to 15. Hence, on the one hand $|G/L|$ is relatively prime to 15 satisfying $G \geq \mathbb{N}_G(C_p) \geq \mathbb{C}_G(C_p) \geq L$ and on the other hand $|G : \mathbb{N}_G(C_p)|$ is not relatively prime to 15 so that (by Lagrange), $|G/L|$ is not relatively prime to 15. This is a contradiction, as required.

The following, perhaps curious, corollary is worth to be mentioned.

Corollary 5.8 *Suppose G is a nonsolvable (P)-group containing a noncyclic Sylow p -subgroup S for some odd prime $p \geq 5$. In addition, assume that for that prime p G does not admit a chief factor isomorphic to $\text{PSL}(2, p^f)$ with $f \geq 2$. Then $S \triangleleft G$ holds. Moreover, S is elementary abelian.*

Proof Assume G is a counterexample of minimal order to the statement of the corollary. We distinguish three cases: 1) $|S \cap \mathbb{F}(G)| \geq p^2$; 2) $|S \cap \mathbb{F}(G)| = p$; 3) $|S \cap \mathbb{F}(G)| = 1$.

Re 1) By Theorem 5.7, it holds that $S \cap \mathbb{F}(G) \trianglelefteq G$, that $S \cap \mathbb{F}(G) \in \text{Syl}_p(G)$ whence $S \cap \mathbb{F}(G)$ is elementary abelian. This contradicts the assumption of G being a counterexample of minimal order to the corollary.

Re 2) Put $S \cap \mathbb{F}(G) = \langle c \rangle$ with $c \in \mathbb{F}(G)$ being of order p . The p -group S is noncyclic and of odd order. Hence, by ([8], III. 8.2.a Satz), there exists a $d \in S$ with $|d| = p$ satisfying $d \notin \langle c \rangle$. Since G is a (P)-group, it leads to $\langle c, d \rangle \leq \mathbb{F}(G)$, contrary to $|S \cap \mathbb{F}(G)| = p$.

Re 3) Here one has $p \nmid |\mathbb{F}(G)|$. Again, we distinguish two cases: a) $|\mathbb{F}(G)| \neq 1$ b) $|\mathbb{F}(G)| = 1$

Re 3) a) Suppose firstly $\mathbb{F}(G) \neq \{1\}$ and that $|\mathbb{F}(G)|$ is divisible by two distinct primes. As $\mathbb{F}(G)$ is nilpotent, it leads to the existence of two nontrivial characteristic subgroups M and U of $\mathbb{F}(G)$ satisfying $M \cap U = \{1\}$ with $(|M|, |U|) = 1$. By induction, each of the (P)-groups G/M and G/U does contain a normal Sylow p -subgroup isomorphic to S . Hence, G , being isomorphic to $G/(M \cap U)$, can be isomorphically embedded into $G/M \times G/U$, while observing that now G contains a normal Sylow p -subgroup isomorphic to S . This contradicts the assumption that G is a counterexample to the statement of the corollary. Thus, we may assume now that $\mathbb{F}(G) \neq \{1\}$ and that $\mathbb{F}(G)$ is a q -group for some prime $q \neq p$. We distinguish two cases: 1) $\mathbb{E}(G) \neq \{1\}$ and 2) $\mathbb{E}(G) = \{1\}$.

Re 3a)1) We work here with $\mathbb{F}(G)$ being a nontrivial q -group with $q \neq p$ and $\mathbb{E}(G) \neq \{1\}$. Hence, it is known that $\mathbb{E}(G)/\zeta(\mathbb{E}(G))$ is simple nonabelian. Put $A = \mathbb{E}(G)' \cap \zeta(\mathbb{E}(G))$. We know that A is isomorphic to a subgroup of the Schur multiplier of $\mathbb{E}(G)/\zeta(\mathbb{E}(G))$. Hence, the order of A is equal to 4, or to 2 or to 1, by what has been seen earlier in our article. If $|A|$ would be 4, then this could only happen when $\mathbb{E}(G)/\zeta(\mathbb{E}(G))$ is isomorphic to $\text{Sz}(2^3)$, in which case A would appear be isomorphic to $C_2 \times C_2$.

Next, assume that $|A| \neq 1$. That assumption can be dismissed off as follows. The (P)-group G/A , being of smaller order than the order of G , does contain a normal Sylow p -subgroup SA/A isomorphic to S . Notice $SA \trianglelefteq G$. We have $p \geq 5$. Hence, as A is either cyclic of order 2 or otherwise elementary abelian of order 4, it follows that SA does happen to be in both cases a direct product of a characteristic subgroup isomorphic to S and of a characteristic subgroup isomorphic to A . Hence, the given Sylow p -subgroup S of G would nevertheless turn out to be normal in G , a contradiction.

Thus, let us continue with $A = \{1\}$. Then the simple group $\mathbb{E}(G)/\zeta(\mathbb{E}(G))$ is isomorphic to $(\mathbb{E}(G)/\zeta(\mathbb{E}(G)))' \cong \mathbb{E}(G)' / (\mathbb{E}(G)' \cap \zeta(\mathbb{E}(G))) \cong \mathbb{E}(G)'$. We then have landed into one of the Theorems 5.1–5.5 from which it follows that G is not a counterexample to the corollary; notice that under the assumptions $p \geq 5$ of this corollary, all odd such p provide cyclic Sylow subgroups of G in Theorems 4.2 and 5.1–5.5. In particular, one has to notice that the Sylow p -subgroups of the three groups M_{11} , M_{23} , J_1 happen all to be cyclic as soon as $p \geq 5$ is assumed! Thus, we are done again. It follows that we may proceed with $\mathbb{F}(G) \neq \{1\}$ and $\mathbb{E}(G) = \{1\}$.

Re 3a)2) Thus, as observed earlier, $\mathbb{C}_G(\mathbb{F}(G)) = \mathbb{C}_G(\mathbb{F}(G)\mathbb{E}(G)) = \mathbb{C}_G(\mathbb{F}^*(G)) \leq \mathbb{F}^*(G) = \mathbb{E}(G)\mathbb{F}(G) = \mathbb{F}(G)$ does follow. Now, if $\mathbb{F}(G)$ is cyclic, then $G/\mathbb{C}_G(\mathbb{F}(G))$ (with $\mathbb{C}_G(\mathbb{F}(G)) \leq \mathbb{F}(G)$) is abelian, whence G would be solvable; a contradiction to the assumption of G being nonsolvable. Thus, the Frattini subgroup $\Phi(\mathbb{F}(G))$ of $\mathbb{F}(G)$ has at least index q^2 in the q -group $\mathbb{F}(G)$ by Burnside's Basis Theorem.

Assume $\Phi(\mathbb{F}(G)) \neq \{1\}$. Since $G/\Phi(\mathbb{F}(G))$ is a (P)-group, not a counterexample to the corollary, it follows that there exists $\tilde{S} \triangleleft G/\Phi(\mathbb{F}(G))$ with $\tilde{S} \cong S$. As $(q, p) = 1$, $S\Phi(\mathbb{F}(G))/\Phi(\mathbb{F}(G)) \times (\mathbb{F}(G)/\Phi(\mathbb{F}(G)))$ is a as normal subgroup of $G/\Phi(\mathbb{F}(G))$. Therefore, S acts trivially on $\mathbb{F}(G)/\Phi(\mathbb{F}(G))$ by conjugation, i.e.

$S \leq C_G(\mathbb{F}(G)) \leq \mathbb{F}(G)$ by Burnside; see ([8], III, 3.18 Satz). A contradiction, as $\mathbb{F}(G)$ is an elementary abelian q -group with $q \neq p$.

Hence, it must be that $\Phi(\mathbb{F}(G)) = \{1\}$, i.e. $\mathbb{F}(G)$ is an elementary abelian q -group, so $C_G(\mathbb{F}(G)) = \mathbb{F}(G)$ holds. By induction, the (P)-group $G/\mathbb{F}(G)$ being not a counterexample of minimal order, does contain a normal Sylow p -subgroup \bar{S} isomorphic to S , as $p \nmid |\mathbb{F}(G)|$. Thus, there exists a minimal normal subgroup M of $G/\mathbb{F}(G)$, contained in \bar{S} , with $M \neq \{1\}$. The group M turns out to be cyclic. This rather nontrivial fact is brought up in the theory of (P)-groups in Sezer's article ([14], (4.2) Lemma and (4.3) Lemma); here $\mathbb{F}(G)$ being elementary abelian is also used, in as much as $\mathbb{F}(G)$ being a chief factor of G [The case $F \triangleleft G$ with $1 < F < \mathbb{F}(G)$ is not possible, as $\text{Exp}(\mathbb{F}(G)) = q$ and all subgroups of order q also being pressed into F by the (P)-group property of G]. Therefore, inside M , there exists a cyclic group $C \triangleleft G/\mathbb{F}(G)$ of order p . Since $G/C_G(\mathbb{F}(G)) (= G/\mathbb{F}(G))$ is a (P)-group, the group $G/C_G(\mathbb{F}(G))$ does possess precisely one subgroup of order p . Therefore, as p is odd, ([8], III. 8.2.a Satz) tells us that \bar{S} itself has to be a cyclic p -subgroup, contrary to the assumption of S being noncyclic. All this settles case a). We proceed with b) $\mathbb{F}(G) = \{1\}$.

Re 3) b) There remains to investigate the situation $\mathbb{F}(G) = \{1\}$. Notice that $\mathbb{F}^*(Y) \neq \{1\}$ for any group $Y \neq \{1\}$. Therefore, $\mathbb{E}(G)$, being here equal to $\mathbb{E}(G)\mathbb{F}(G)$, i.e. equal to $\mathbb{F}^*(G)$, is not trivial. Furthermore, $\zeta(\mathbb{E}(G)) \leq \mathbb{F}(G) = \{1\}$ leads to the fact that the (P)-group G does contain a unique normal subgroup being nonabelian see Theorem 2.3. Next, apply the contents of the statements in Theorems 4.2 and 5.4. Notice that each Sylow t -subgroup for each prime t at least 5 in the groups appearing in the assumptions of the corollary in connection to the relevant statements on N in Theorems 4.2, 5.1, and 5.4, is de facto cyclic. Therefore, no counterexample to the statements of the corollary does exist.

The proof of the corollary is complete. □

It remains to determine the structure of a nonsolvable (P)-group G admitting a chief factor L/K whose Schur multiplier $\mathcal{M}(L/K)$ is isomorphic to C_2 . Indeed, only $\mathcal{M}(L/K) \cong C_2$ with $L/K \cong \text{PSL}(2, p^m)$ (p odd prime, $m \geq 1$, $p^m \geq 5$) must hold for such a G .

Theorem 5.9 *Let G be a (P)-group admitting some L/K as a chief factor $L/K \cong \text{PSL}(2, p^m)$, where p is an odd prime, $m \geq 1$, $p^m \geq 7$. Then one of the next two statements does occur.*

- 1) *There exists $M \trianglelefteq G$ with $M \cong \text{PSL}(2, p^m)$ with $2 \nmid |G/M|$ and $2 \nmid |K|$. The structure of such a G is described in Theorem 5.4.*
- 2) *There exists $\bar{M} \trianglelefteq G$ with $\bar{M} \cong \text{SL}(2, p^m)$, $(|\bar{M}|, |G/\bar{M}|) = 1$ and m odd. In addition, one gets $\bar{M} \rtimes V$, a semidirect product of \bar{M} with a solvable (P)-group V such that $(|\bar{M}|, |V|) = 1$ where $G/\zeta(\bar{M})$ has the structure of the groups occurring in Theorem 5.4.*

Proof It will turn out that the assumption $2 \mid |K|$ leads to considerations popping up in case 2). In the proof of each of the statements 1) and 2), we assume that G is a counterexample of minimal order to the respective statements of the theorem.

Re 1) Here we work under the assumption that 2 does not divide the order of K . Now, do follow the arguments in the proof of Theorem 5.5, cases Re α and Re β . Thus, analogously to the proof of Re β there, notice

that now $|L' \cap \zeta(L)| \leq 2$ due to $\mathcal{M}(L/K) \cong C_2$. As in Re β , $(|L'|, |\zeta(L)|) = 1$ has to hold where K is a minimal normal, whence elementary abelian, subgroup of G (possibly $K \cong C_p$). Just as in Re β , one gets $L' \trianglelefteq G$ with $L' \cong \text{PSL}(2, p^m)$. Next, analogously to Re α , one gets that the (P)-group $G/\mathbb{C}_G(K)$ ultimately satisfies $\mathbb{C}_G(K) = K$ and by induction the existence of $U/\mathbb{C}_G(K) \trianglelefteq G/\mathbb{C}_G(K)$ with $U \trianglelefteq G$ and $U/\mathbb{C}_G(K) \cong \text{PSL}(2, p^m)$ is guaranteed. Notice that $t \nmid |G/\mathbb{C}_G(K)|$ holds by Theorem 5.7, when $t^2 \mid |K|$, t odd prime, in conjunction to Theorem 5.7. [The case $|K|$ is an odd prime can be easily dismissed]. Hence, apparently, we do find ourselves in one of the nine structures occurring in Hering's theorem. Now due to $(|G/\mathbb{C}_G(K)|, |K|) = (|G/K|, |K|) = 1$, $\mathbb{C}_G(K) = K$ and $2 \nmid |K|$ with $|K| = t^u$ ($u \geq 2$, t odd prime), Hering's theorem tells us that

- a) the cases 3), 6), 7), and 9) do not occur for G as $t \neq 2$;
- b) the cases 1), 2), 8) do not occur for G as $t \nmid |G/K|$;
- c) the case 4) does not occur as G is not a solvable (P)-group;
- d) the case 5) does not occur as it is assumed in the assumption of the theorem that $p^m = 5$ will not be considered.

Therefore, by induction, assertion 1) of the theorem has been verified.

Re 2) It has to be shown by induction that there has to exist a normal subgroup \overline{M} of G satisfying $\overline{M} \cong \text{SL}(2, p^m)$ with $2 \nmid |G/\overline{M}|$, if $2 \mid |K|$ is given. The proof will be given in a series of steps. It holds by Theorem 5.4 that for any factor group G/T of G/R with $R \trianglelefteq G$ and $T/R \trianglelefteq G/R$ ($T \trianglelefteq G$) with $T/R \cong \text{PSL}(2, p^m)$, G/R is a (P)-group with $|G/T| = |(G/R)/(T/R)| \equiv 1 \pmod{2}$ and $(|G/T|, |T/R|) = 1$. This property will be used throughout rest of the proof of the theorem. In particular, one has then $2 \mid |R|$; this fact will be used frequently too.

Re 2)1) Suppose $M \trianglelefteq G$ is a minimal normal subgroup of G contained in K , satisfying $2 \nmid |M|$. Then either $M \cong C_t$ for some odd prime t or else M is a noncyclic elementary abelian t -subgroup of G . In the last case, $\{M\} = \text{Syl}_t(G)$ as shown in Theorem 5.7, a property also to be used in what follows.

Re 2) 1) a) Suppose $M \cong C_t$. Then $G/\mathbb{C}_G(M) \hookrightarrow C_{t-1}$. Hence, w.l.o.g., by induction and Jordan–Hölder's theorem, we may assume that $\overline{L}/\overline{K} \cong \text{PSL}(2, p^m)$ is a chief factor of G satisfying $|\overline{K}/M| = 2$ (due to $2 \mid |K/M|$ and $|G/\overline{L}|$ odd). Hence, $\overline{K} \cong C_2 \times C_t$, whence there exists a normal subgroup $\tilde{C} \leq \overline{K}$ of order 2 of G . The (P)-group G/\tilde{C} now does satisfy Theorem 5.4. Thus, there exists $\tilde{K} \trianglelefteq G$ with $\tilde{K} \geq \tilde{C}$ such that $\tilde{K}/\tilde{C} \cong \text{PSL}(2, p^m)$. Since G is a (P)-group, it follows that G now possesses a unique involution, yielding $\tilde{K} \cong \text{SL}(2, p^m)$. In this case, the theorem has been proved.

Re 2) 1) b) Suppose $M \cong C_t \times C_t \times \dots \times C_t$ of order t^n ($n \geq 2$). By induction and Jordan–Hölder, the (P)-group G/M does contain some $\tilde{K} \trianglelefteq G$ with $\tilde{K}/M \trianglelefteq G/M$ satisfying $\tilde{K}/M \cong \text{SL}(2, p^m)$ with $2 \nmid |(G/M)/(\tilde{K}/M)| = |G/\tilde{K}|$ and $(|G/\tilde{K}|, |\tilde{K}/M|) = 1$. Hence, by the (P)-group property of G , any element τr of G with $\tau \in G$ and $r \in M$ and $(\tau r)^2 \in M$ but $\tau r \neq 1$, has the property that either each τr centralize M or else that each τr inverts $e \in M$, $e \neq 1$ under conjugation action. In case τ acts trivially on M , then one can reason just as in case Re 2) 1) a) in order to conclude that the theorem holds. Therefore, one can assume that τ inverts all elements of $M \setminus \{1\}$. Notice that $M\langle\tau\rangle/M = \zeta(\tilde{K}/M)$ as all the involutions of the (P)-group G/M are in fact contained in the group \tilde{K}/M , where $\tilde{K}/M \cong \text{SL}(2, p^m)$. Hence, all involutions of the (P)-group

G are contained in $M\langle\tau\rangle$; notice that the Sylow 2-subgroups of \tilde{K} (whence also of G as $2 \nmid |G/\tilde{K}|$) are generalized quaternion. All these things yield $2 \nmid |\mathbb{C}_G(M)/M|$ and $(|\mathbb{C}_G(M)/M|, |M|) = 1$. Hence, either $\mathbb{C}_G(M) = M$ or else $\mathbb{C}_G(M)$ does contain a characteristic subgroup D of $\mathbb{C}_G(M)$, whose order being an odd number greater than 1, is relatively prime to t , with $\mathbb{C}_G(M) = MD$ and $M \cap D = \{1\}$. In the last case G is isomorphic to a subgroup of the direct product of the (P)-groups G/D and G/M . Now, if D contains a minimal normal subgroup N of G , not trivial and cyclic of prime order, then one can argue as in Re 2)1)a) and conclude that the conclusion of the theorem holds, i.e. G contains a normal subgroup isomorphic to $SL(2, p^m)$ or $PSL(2, p^m)$. Thus, suppose the above group is nilpotent and not cyclic. Then, by Theorem 5.7, $\{N\} = \text{Syl}_u(G)$ for some odd prime u different from t . Next, observe that $N \cap M = \{1\}$ and that G/N , G/M and G/NM are (P)-groups each satisfying the first conclusion of the theorem, i.e. there exists $G \supseteq B \supseteq MN$ with $B/MN \cong SL(2, p^m)$; notice $(|G/B|, |B/MN|) = 1$. The group G/N does also contain a normal subgroup $E/N \cong SL(2, p^m)$ with $E \trianglelefteq G$. Hence, as $\{MN/N\} = \text{Syl}_t(G)$ one gets that B/N is the direct product of the groups E/N and MN/N . Likewise, as $\{MN/N\} = \text{Syl}_u(G)$, there exists $F \trianglelefteq G$ with $F \supseteq M$ such that $F/M \cong SL(2, p^m)$. Hence, also B/M is the direct product of F/M and MN/M . Since $(|MN|, |B/MN|) = 1$, by the Schur-Zassenhaus theorem, there exists $W \leq G$ with $W = BMN$ and $W \cap MN = \{1\}$, where $W \cong SL(2, p^m)$. Now WMN/N centralizes MN/N and WMN/M centralizes MN/M . Hence, when $w \in W$ and $n \in N$ one has $wM \cdot nM = nM \cdot wM$, i.e. $wnw^{-1}n^{-1} \in M$, but surely $wnw^{-1}n^{-1} \in N$ holds too as $N \trianglelefteq G$. Thus, $wnw^{-1}n^{-1} \in N \cap M = \{1\}$. Likewise, $wmw^{-1}m^{-1} \in N \cap M = \{1\}$ for all $w \in W$ and $m \in M$. Thus, as $(|W|, |MN|) = 1$, it follows that W is a characteristic subgroup of the inner direct product of the groups W and MN , since $W \trianglelefteq G$. Herewith the proof of the theorem is concluded when $\mathbb{C}_G(M) \not\cong M$.

Re 2) 1) c) Therefore, we proceed with the assumption $\mathbb{C}_G(M) = M$, $M \not\cong C_t$, $M \cong C_t \times C_t \times \dots \times C_t$, $|M| = t^f$, $f \geq 2$, t odd prime. As G is a (P)-group, $t \nmid |G/M|$ holds as shown in Theorem 5.7. Once again, let us bring Hering's theorem into play yielding nine specific structures. All these cases can be dismissed off as follows. In cases 1) and 2) one has $t \mid |G/M|$ or G is solvable, a contradiction; in case 3) $t = 2$ might only appear as well as in the cases 6), 7), and 9), a contradiction; in case 4) one has either to do with a solvable (P)-group G or else with $t^f = 3^4$ but then this is in conflict with $L/K \cong PSL(2, p^m)$ and $3 \mid |L/K| \mid |G/M|$ and $3 = t \nmid |G/M|$; in case 5) one has a contradiction to the assumption $L/K \cong PSL(2, p^m)$ with $p^m \geq 7$; finally in case 8) one has $t = 3$ and $G/M \cong SL(2, 13)$, a contradiction to the property $3 = t \nmid |G/M|$. The case Re 2) 1) leads therefore by induction, to the proof of the theorem.

Thus, let us proceed with the possibility that the Fitting subgroup $\mathbb{F}(K)$ of K is a (possibly trivial) 2-group.

Re 2) 2) Suppose that $\mathbb{F}(K)$ is a 2-group. In fact, $\mathbb{F}(K) \neq \{1\}$. Remember that, due to Theorem 2.3, K is solvable and look at the premise of Re 2)1).

Re 2) 2) a) Let us first assume that $2 \mid |K/\mathbb{F}(K)|$. Then by induction, there exists inside the (P)-group $G/\mathbb{F}(K)$, a chief factor $(\tilde{L}/\mathbb{F}(K))/(\tilde{K}/\mathbb{F}(K))$ with $\tilde{L}/\mathbb{F}(K) \cong PSL(2, p^m)$ and with $\tilde{K} \trianglelefteq G$, $\tilde{L} \trianglelefteq G$, $\tilde{K} < \tilde{L}$, satisfying $|\tilde{K}/\mathbb{F}(K)| = 2$ and with $\tilde{L}/\mathbb{F}(K) \cong SL(2, p^m)$. It follows that $\tilde{K} = \mathbb{F}(\tilde{K})$, since \tilde{K} is a 2-group. It holds that $|\tilde{K}|$ is divisible by 4. Consider $\tilde{K}/\Phi(\tilde{K})$. If $4 \mid |\tilde{K}/\Phi(\tilde{K})|$, the elementary abelian

noncyclic 2-group $\tilde{K}/\Phi(\tilde{K})$ must be a chief section of the (P)-group $G/\Phi(\tilde{K})$, as the nontrivial involutions of $\tilde{K}/\Phi(\tilde{K})$ are conjugate to each other within $G/\Phi(\tilde{K})$. This, however, contradicts $\mathbb{F}(K) \triangleleft G$ with $G \supseteq \tilde{K} = \mathbb{F}(\tilde{K}) \stackrel{2}{>} \mathbb{F}(K) \geq \Phi(\tilde{K})$. Hence, one gets $\tilde{K} \stackrel{2}{\triangleright} \Phi(\tilde{K}) \neq \{1\}$, i.e. \tilde{K} is a cyclic 2-group. Therefore, $|G/\mathbb{C}_G(\tilde{K})| \leq 2$, so that $\mathbb{C}_G(\tilde{K})/\tilde{K}$ is not solvable and a fortiori containing \tilde{L}/\tilde{K} , the latter group being isomorphic to $\text{PSL}(2, p^m)$. Thus, $\tilde{K} \leq \zeta(\tilde{L})$ holds. Moreover, $\tilde{L}/\tilde{K} = (\tilde{L}/\tilde{K})' = \tilde{L}'\tilde{K}/\tilde{K} \cong \tilde{L}'/\tilde{L}' \cap \tilde{K}$. By induction, for the (P)-group G/U via the group $U \trianglelefteq G$ defined by $U := \{l \in \tilde{K} \mid l^2 = 1\}$, one may assume $|\tilde{K}| = 4$ for the cyclic 2-group \tilde{K} [Indeed, $\tilde{K} = \{1\}$ is impossible as $2 \mid |K|$ and $2 \nmid |G/L|$ and $2 \nmid |G/\tilde{L}|$; when $|\tilde{K}| = 2$, then we are done, as in the (P)-group G , $\tilde{L} \not\cong \text{PSL}(2, p^m) \times C_2$]. Now, if $\tilde{L}' \cap \tilde{K} = \{1\}$, then $\tilde{L} = \tilde{L}' \times \tilde{K}$ and so $\tilde{L}' \cong \text{PSL}(2, p^m)$ with $\tilde{L}' \triangleleft G$, a contradiction to $2 \nmid |G/\tilde{L}'|$ and $2 \mid |K|$. If $\tilde{L}' \cap \tilde{K} \cong C_2$, then $\tilde{L}'/\Omega_1(\tilde{K}) \cong \text{PSL}(2, p^m)$ and in fact $\tilde{L}' \cong \text{SL}(2, p^m)$ does hold here and we are done again. If \tilde{L}'/\tilde{K} , then $\tilde{L} = \tilde{L}'$ and $\tilde{K} = \tilde{K} \cap \tilde{L} = \tilde{K} \cap \tilde{L}' \leq \zeta(\tilde{L}) \cap \tilde{L}'$. However, as the Schur multiplier of $\mathcal{M}(\tilde{L}/\tilde{K})$ is isomorphic to C_2 , one finds by ([11], 2.1.7 Theorem) that $\zeta(\tilde{L}) \cap \tilde{L}'$ is isomorphic to a subgroup of $\mathcal{M}(\tilde{L}/\tilde{K})$, a contradiction to $4 = |\tilde{K}| \leq |\zeta(\tilde{L}) \cap \tilde{K}'|$. Therefore, the case in which it is supposed that 2 divides $|K/\mathbb{F}(K)|$ has been dealt with.

Re 2) 2) b) Let us therefore assume that $|K/\mathbb{F}(K)|$ is odd; $K = \mathbb{F}(K)$ might happen too here. Remember that we still do find ourselves in case Re 2) 2) in which $\mathbb{F}(K)$ is a 2-group and that K is solvable and $2 \mid |K|$, whence $\mathbb{F}(K) \neq \{1\}$ holds. Now, if $K \neq \mathbb{F}(K)$, then we may assume by induction on the (P)-group $G/\mathbb{F}(K)$, due to $2 \mid |K|$ and $2 \nmid |K/\mathbb{F}(K)|$, that Re 2) 1) is fulfilled, i.e. there exists $\tilde{K} \trianglelefteq G$, $\tilde{L} \trianglelefteq G$, $\tilde{K} < \tilde{L}$ satisfying $\tilde{L}/\tilde{K} \cong \text{PSL}(2, p^m)$ and $\tilde{K} = \mathbb{F}(K)$. If $|\tilde{K}| = 2$, then $\tilde{L} \cong \text{SL}(2, p^m)$ as G is a (P)-group and also $\mathcal{M}(\tilde{L}/\tilde{K}) \cong C_2$. [Indeed, notice that, if $\tilde{K} \cong C_2$, \tilde{L} can only contain generalized quaternion Sylow 2-subgroups due to the (P)-group property of G]. Therefore, in case $|\tilde{K}| = 2$, we are done again. Thus, let $|\tilde{K}| \mid 2^\alpha$ ($\alpha \geq 2$). Now, if \tilde{K} happens to be cyclic, then one is able to establish the truth of the theorem, just as it was done in case Re 2)2)a). Thus, assume \tilde{K} is not cyclic. Suppose $1 \neq T$ is a minimal normal subgroup of G , where $T \leq \tilde{K}$ holds. Two cases can happen: α) $|\tilde{K}/T|$ is divisible by 2; β) $\tilde{K} = T$, i.e. \tilde{K} is an elementary abelian 2-group.

Re 2) 2) b) α) Suppose $2 \mid |\tilde{K}/T|$. Then the theorem holds for the (P)-group G/T , by induction. Thus, without loss of generality, we may assume $\tilde{L}/T \cong \text{SL}(2, p^m)$, whence $|\tilde{K}/T| = 2$. Since also $G/\Phi(\tilde{K})$ is a (P)-group permuting the involutions of $G/\Phi(\tilde{K})$ transitively, and as $\text{Exp}(\tilde{K}/\Phi(K)) = 2$ one must have $\tilde{K} \stackrel{2}{\triangleright} T = \Phi(\tilde{K}) \neq \{1\}$. In other words, \tilde{K} is a cyclic 2-group of order at least 4. Now one gets by the same reasoning as in a part of Re 2)2)a), that this leads to a contradiction to the (P)-property assumption for a nonsolvable group.

Re 2) 2) b) β) Suppose $\tilde{K} = T$ is an elementary abelian group of order $2^n \geq 4$. Consider the subgroup inclusions $\tilde{K} \leq \mathbb{C}_G(\tilde{K}) \cap \tilde{L} \leq \tilde{L}$. Notice also now that \tilde{K} is a minimal normal (and elementary abelian) 2-subgroup of G , as G is a (P)-group. Since \tilde{L}/\tilde{K} is simple nonabelian, either $\tilde{K} = \mathbb{C}_G(\tilde{K}) \cap \tilde{L} < \tilde{L}$ or $\tilde{K} < \mathbb{C}_G(\tilde{K}) \cap \tilde{L} = \tilde{L}$ holds. Once again we distinguish two cases \bar{a} and \bar{b} .

Re 2) 2) b) $\beta)\bar{a}$ Assume $\tilde{K} = \mathbb{C}_G(\tilde{K}) \cap \tilde{L}$. Hence, as we know that $(|\mathbb{C}_G(\tilde{K})\tilde{L}/\tilde{L}|, |\tilde{L}/\tilde{K}|) = 1$, it holds that $|\mathbb{C}_G(\tilde{K})\tilde{K}/\tilde{K}|$ is odd. Thus, when $\mathbb{C}_G(\tilde{K}) \neq \tilde{K}$ occurs, then $\mathbb{C}_G(\tilde{K})$ is the inner direct product of the groups \tilde{K} and W , say, where $2 \nmid |W|$, \tilde{K} being a 2-group. Hence, W is characteristic in $\mathbb{C}_G(\tilde{K})$, so normal of odd order in G . The proving procedure has now been reduced to the already settled Re 2)2)a) case in which there exists some chief factor $\hat{L}/\hat{K} \cong \text{PSL}(2, p^m)$ with some $\hat{K} \trianglelefteq G$, $\hat{K} \geq W$, $\tilde{L} \trianglelefteq G$; such a chief factor does exist in G by the Jordan–Zassenhaus–Hölder theorem. Thus, assume $\mathbb{C}_G(\tilde{K}) \cap \tilde{L} = \tilde{K}$ but also $\mathbb{C}_G(\tilde{K}) = \tilde{K}$. Then the nine structures from Hering’s Theorem provide the following insights:

The cases 4) 5) and 8) do not occur since in Hering’s theorem it would hold that some Chevalley group $G_2(2^m)$ is normal in our group G/\tilde{K} [and notice too that no $\text{PSL}(2, \mathbb{F}_q)$ is isomorphic to $\text{PSL}(2, \mathbb{F}_r)$, $q \neq r$];

The cases 6), 7) and 9) do not occur in our proof, as no A_6 , A_7 or $\text{PSU}(3, 9)$ is isomorphic to any $\text{PSL}(2, p^m)$ with p odd prime, m odd, $p^m \geq 7$;

Likewise, the cases (1) and (2) do not occur here for $\text{PSL}(2, p^m)$ with p odd prime, m odd, $p^m \geq 11$, and none of those $\text{PSL}(2, p^m)$ is isomorphic to some $\text{SL}(2, 2^a)$.

On the other hand, the isomorphism between the groups $\text{PSL}(2, 7)$ and $\text{SL}(3, 2)$ must be studied separately. It is worked out in the next theorem. As such, it turns out that no such (P)-group G exists containing a normal elementary abelian 2-group H of order at least 8 and satisfying $\mathbb{C}_G(H) = H$ with $L \trianglelefteq G$, $H \leq L$, $L/H \cong \text{SL}(3, 2)$. [As to all these (non)isomorphism properties, view the article of Artin ([1], Theorem 2, page 466)]. All these items do settle the case \bar{a} .

Re 2) 2) b) $\beta)\bar{b}$ Assume $\mathbb{C}_G(\tilde{K}) \cap \tilde{L} = \tilde{L}$, i.e. $\tilde{K} \leq \zeta(\tilde{L})$. Remember that \tilde{K} is a minimal normal (and elementary abelian) 2-subgroup of G with $|\tilde{K}| > 4$. One has $\tilde{L}' \cap \tilde{K} \leq \tilde{L}' \cap \zeta(\tilde{L})$ and $\tilde{L}' \cap \zeta(\tilde{L})$ is isomorphic to a subgroup of the Schur multiplier $\mathcal{M}(\tilde{L}/\tilde{K})$ of \tilde{L}/\tilde{K} whence $|\tilde{L}' \cap \zeta(\tilde{L})| \leq 2$. Since \tilde{K} is a chief factor of G , it follows that $\tilde{L}' \cap \tilde{K} = \{1\}$, also due to $|\tilde{K}| > 4$. Thus, as here \tilde{L} is equal to $\tilde{L}'\tilde{K}$ (as $\tilde{L}/\tilde{K} = (\tilde{L}'\tilde{K})/\tilde{K} = \tilde{L}'\tilde{K}/\tilde{K}$), the property $\tilde{L}' \cap \tilde{K} = \{1\}$ yields that no involution of G is contained in \tilde{L}' (using the (P)-property for G that all involutions of G must be contained in \tilde{K}) as $\tilde{L}' \trianglelefteq G$. On the other hand, $\tilde{L}' \cong \tilde{L}'/(\tilde{L}' \cap \tilde{K}) \cong \tilde{L}'\tilde{K}/\tilde{K} = (\tilde{L}'\tilde{K})/\tilde{K} = \tilde{L}'\tilde{K}/\tilde{K}$ holds, where $\tilde{L}'\tilde{K}$ is isomorphic to some $\text{PSL}(2, 2^m)$, p odd prime, m odd, $p^m \geq 7$; a contradiction to $2 \nmid |\tilde{L}'|$ just obtained. Hence, case \bar{b} does not occur.

The theorem has been proved. □

It was observed in the proof of Theorem 5.9 that one detail had to be filled in, due to the isomorphism $\text{PSL}(2, 7) \cong \text{SL}(3, 2)$. It runs as follows.

Theorem 5.10 *Let us assume that a group G does contain an elementary abelian normal 2-subgroup A whose order is at least 4. Suppose that $\mathbb{C}_G(A) = A$ and that $A = \mathbb{C}_G(A) \leq K \leq G$ does satisfy $K/\mathbb{C}_G(A) \cong \text{PSL}(2, 7) \cong \text{SL}(3, 2)$. Then G is not a (P)-group.*

Proof It holds trivially that $\text{SL}(3, 2) = \text{GL}(3, 2)$. Suppose that G is a (P)-group; we will get a contradiction, as follows.

Put $|A| = 2^\alpha$ ($\alpha \geq 2$). Thus, it is assumed now that G permutes all the involutions of G transitively under conjugation action. Hence, all involutions of G are contained in A ; there are $2^\alpha - 1$ such elements in G . Hering's theorem, referred to so often in this article, does reveal that the group $G/C_G(A)$ must contain a normal subgroup isomorphic to $SL(k, 2^m)$ where $\alpha = km$; notice that in Hering's theorem only the cases 1) and 2) might be taken into account on consideration. Since $SL(3, 2)$ is a chief factor of the (P)-group G , it follows from the Jordan-Hölder-Zassenhaus Theorem when applied to the solvable group G/K and A , that $km = \alpha = 3$, [Here too it is used à la Artin in ([1], Theorem 2, page 466), that no other isomorphisms between a group from the series $SL(-, 2^t)$ and $Sp(-, 2^t)$ with the group $SL(3, 2)$ does exist. Hence, indeed, as G is not solvable, one gets $k = 3$ and $m = 1$]. The elements in a full set of representatives of nontrivial cosets of A in K , do act by conjugation on the group A of order 8, like the nontrivial elements of the linear group $GL(3, 2)$ do act transitively on the nonzero vectors of the 3-dimensional vector space V over the field consisting of two elements. The following can be regarded as a deus ex machina. Namely, look at the vectors $\begin{pmatrix} 1 \\ 0 \\ 0 \end{pmatrix}$, $\begin{pmatrix} 1 \\ 0 \\ 1 \end{pmatrix}$, and $\begin{pmatrix} 0 \\ 1 \\ 1 \end{pmatrix}$; together with $\begin{pmatrix} 0 \\ 0 \\ 0 \end{pmatrix}$, these constitute an additive Klein-four subgroup Kl of $(\mathbb{F}_2^3)^+$. Notice, $a := \begin{pmatrix} 0 & 0 & 1 \\ 1 & 0 & 0 \\ 0 & 1 & 0 \end{pmatrix} \in GL(3, 2)$ has multiplicative order 3. The additive group Kl remains invariant under the linear action of each of the elements of the subgroup $\{1, a, a^2\} < GL(3, 2)$. Look at the element $b := \begin{pmatrix} 1 & 0 & 0 \\ 0 & 0 & 1 \\ 0 & 1 & 0 \end{pmatrix} \in SL(3, 2)$. Not only $bab^{-1} = a^{-1}$ with $|b| = 2$ but even more important, the group Kl remains invariant under the linear action of the group $\langle a, b \rangle$, where the elements of $Kl \setminus \begin{pmatrix} 0 \\ 0 \\ 0 \end{pmatrix}$ are being permuted transitively as direct calculation shows. Thus, there exist elements $\bar{a}, \bar{b} \in K$ with $|\bar{a}| = 3$ occurring in distinct cosets of A in K , acting inter alia on each other and on particular elements of $\bar{c} \neq 1$ and $\bar{d} \neq 1$ from A , in a one-one compatible way as the respective elements $a, b \in SL(3, 2)$ among each other and on $\begin{pmatrix} 1 \\ 0 \\ 0 \end{pmatrix}$, $\begin{pmatrix} 1 \\ 0 \\ 1 \end{pmatrix}$, and $\begin{pmatrix} 0 \\ 1 \\ 1 \end{pmatrix}$ do. Therefore, we are talking about the existence of a subgroup $\langle \bar{c}, \bar{d}, \bar{a}, \bar{b} \rangle \leq K$ (whence of G) being isomorphic to a group of order 24, containing a normal subgroup $\langle \bar{c}, \bar{d} \rangle$ isomorphic to a Klein-four-group and such that $(\bar{b}A)(\bar{a}A)(\bar{b}A)^{-1} = (\bar{a}A)^{-1}$. Moreover, the commutator subgroup $\langle \bar{c}, \bar{d}, \bar{a}, \bar{b} \rangle$ equals $\langle \bar{c}, \bar{d}, \bar{a} \rangle$, the last group being of order 12. It is known from the classification of all the groups of order 24 admitting a commutator subgroup of order 12 that there exists up to isomorphism only one such group, namely S_4 , the symmetric group of four symbols. The group S_4 does possess nine elements of order 2. Therefore, the group K , and surely G , does possess elements of order 2 outside the normal subgroup A . Therefore, we have got a contradiction against the possibility that a group G satisfying the assumptions of the theorem might be a (P)-group.

The theorem has been proved. □

6. Odd divisors of orders of chief factors of nonsolvable (P)-groups

In this section, a nondivisibility property of odd prime divisors of the order of a nonabelian chief factor of a (P)-group will be presented in the next theorem. A complete proof will be given on its own account, perhaps repeating previous ideas of argumentation.

Theorem 6.1 *Let G be a nonsolvable (P)-group and let L/K be nonabelian chief factor of G . Then no odd prime divisor of $|L/K|$ divides the integer $|G|/|L/K|$.*

Proof It has been shown in Theorem 2.3 that in each chief series of a (P)-group there occurs at most one nonabelian chief factor and that each such a chief factor is isomorphic to a simple nonabelian group. Thus, for any choice of a chief series of G , such simple nonabelian chief factor is in fact isomorphic to some particular simple nonabelian group; see the Jordan–Hölder–Zassenhaus Theorem. Let us presume the existence of a nonsolvable (P)-group G , being a counterexample of smallest order to the assertion of the theorem. Note that $\mathbb{F}^*(X)$ is nontrivial for any group X and that $\mathbb{F}^*(X) = \mathbb{E}(X)\mathbb{F}(X)$, where $[\mathbb{E}(X), \mathbb{F}(X)] = 1$; see ([2], 11 (31.12)) and the introduction to our article. The proof of the theorem will now follow from a series of steps.

- 1) Suppose there exists $1 \neq S_p \in \text{Syl}_p(\mathbb{F}(G))$ and $1 \neq S_q \in \text{Syl}_q(\mathbb{F}(G))$ for some distinct primes p and q . Then, as $S_p \triangleleft G$, $S_q \triangleleft G$ and $S_p \cap S_q = \{1\}$ it holds that G/S_p , G/S_q and $G/(S_p S_q)$ are nonsolvable (P)-groups each of smaller order than $|G|$. Hence, the theorem holds for those three groups. There exists here a nonabelian simple chief factor L/K of G with $K \geq S_p S_q$, so for each odd prime $t \mid |L/K|$ it holds that $t \nmid |G/L||K/S_p|$ and $t \nmid |G/L||K/S_q|$. Hence, $t \nmid |G/L||K|$, contrary to the choice of G . Hence, $\mathbb{F}(G)$ must be a group of prime power order or $\mathbb{F}(G) = \{1\}$.
- 2) Suppose $\mathbb{F}(G)$ is a nontrivial 2-group. Then there exists a nonabelian chief factor L/K of G with $K \geq \mathbb{F}(G)$. Let p be an arbitrary odd prime dividing $|L/K|$. The conclusion of the theorem is fulfilled for the (P)-group $G/\mathbb{F}(G)$ with respect to the simple nonabelian group $(L/\mathbb{F}(G))/(K/\mathbb{F}(G))$. Thus, it follows that $p \nmid \frac{|G/\mathbb{F}(G)|}{|(L/\mathbb{F}(G))/(K/\mathbb{F}(G))|}$, resulting in $p \nmid \frac{|G/\mathbb{F}(G)|}{|L/K|}$. Hence, as $\mathbb{F}(G)$ is a nontrivial 2-group, we conclude $p \nmid \frac{|G|}{|L/K|}$, contrary to the choice of G . We proceed with $\mathbb{F}(G) = \{1\}$.
- 3) Suppose $\mathbb{F}(G) = \{1\}$. Hence, $\mathbb{C}_G(\mathbb{E}(G)) = \mathbb{C}_G(\mathbb{F}^*(G)) \leq \mathbb{F}^*(G) = \mathbb{E}(G)$, where the \leq -sign has been shown to be true in ([2], 11 (31.13)). Hence, we see from $\mathbb{F}(G) = \{1\}$ that the abelian normal subgroup $\mathbb{C}_G(\mathbb{E}(G))$ of G happens to be trivial. As before, it yields that $\mathbb{E}(G)$ is the unique nonabelian chief factor in each chief series of G through $\mathbb{E}(G)$. [Notice $\mathbb{E}(G) \neq \{1\}$ as $\mathbb{F}^*(G) \neq \{1\}$; moreover, $\mathbb{E}(G)$ is simple here in 3)]. Now, due to Theorems 4.2 and 5.2, 1), no odd prime dividing $|\mathbb{E}(G)|$ divides $|G/\mathbb{E}(G)|$, contrary to the choice of G . Hence, $\mathbb{F}(G)$ must be a nontrivial q -group for some odd prime q , by invoking also the steps 1) and 2).
- 4) Suppose $\mathbb{F}(G)$ is a nontrivial q -group, q an odd prime, $\mathbb{F}(G)$ not being elementary abelian noncyclic. In this case, there exists $C \trianglelefteq G$ satisfying $\mathbb{F}(G) > C > \{1\}$. The (P)-group G/C does satisfy the conclusion of the theorem as $|G/C| < |G|$. Let p be an arbitrary odd prime dividing the order of some (simple) nonabelian chief factor $(L/C)/(K/C)$ of G/C with $L \trianglelefteq G$ and $K \trianglelefteq G$ with $L > K \geq C$. If $p \neq q$, then $p \nmid \frac{|G/C|}{|(L/C)/(K/C)|} \in \mathbb{N}$ implies not only $p \nmid \frac{|G/C|}{|L/K|}$ but also $p \nmid \frac{|G/C||C|}{|L/K|}$, contrary to the choice of G . If $p = q$, then $p = q \mid \frac{|G/C|}{|L/K|}$, but this property is impossible as here $p = q$ would not divide $|\mathbb{F}(G)/C|$. Hence, we must carry on with the next alleged possibility in 5).
- 5) Suppose $\mathbb{F}(G)$ is a nontrivial q -group, q an odd prime, whereas $\mathbb{F}(G)$ is elementary abelian or $\mathbb{F}(G)$ is cyclic of order q . We distinguish two cases: a) $\mathbb{E}(G) \neq \{1\}$; b) $\mathbb{E}(G) = \{1\}$.
- 5) a) Let the (P)-group G satisfy $\mathbb{E}(G) \neq \{1\}$ and also the condition in 5). Notice that $\mathbb{E}(G) \cap \mathbb{F}(G) \leq \zeta(\mathbb{F}^*(G))$ holds due to $[\mathbb{E}(G), \mathbb{F}(G)] = 1$. In 4), we saw implicitly that one may assume $\mathbb{E}(G) \cap \mathbb{F}(G) = \{1\}$ or else

$\mathbb{E}(G) \cap \mathbb{F}(G) = \mathbb{F}(G)$. Assume $\mathbb{E}(G) \not\cong \mathbb{F}(G)$. Then $\mathbb{E}(G) > \mathbb{F}(G) = \zeta(\mathbb{E}(G))$ does follow. Now, we know from Theorem 2.4 that $\mathbb{E}(G)/\zeta(\mathbb{E}(G))$ is nonabelian simple. Thus, $\mathbb{E}(G) = [\mathbb{E}(G), \mathbb{E}(G)]\zeta(\mathbb{E}(G))$ holds. As in fact $[\mathbb{E}(G), \mathbb{E}(G)] = \mathbb{E}(G)$ holds, one observes that $[\mathbb{E}(G), \mathbb{E}(G)] \cap \zeta(\mathbb{E}(G)) = \mathbb{E}(G) \cap \zeta(\mathbb{E}(G)) = \zeta(\mathbb{E}(G)) = \mathbb{F}(G)$ is contained, as isomorphic copy, in the Schur multiplier of the simple group $\mathbb{E}(G)/\mathbb{F}(G)$. Therefore, by Theorems 4.2 and 4.1 in conjunction with ([11], 2.1.7 Theorem), one gets that $\mathbb{F}(G)$ is a 2-group of order 1 or 2 or 4; a contradiction to $\mathbb{F}(G)$ being a q -group, q odd prime.

Assume $\mathbb{E}(G) \cap \mathbb{F}(G) = \{1\}$. Since G is a (P)-group, it yields now also $(|\mathbb{E}(G)|, |\mathbb{F}(G)|) = 1$. As here $\mathbb{E}(G) \neq 1 \neq \mathbb{F}(G)$, we are immediately able to conclude, more or less analogously to former lines, that this assumption leads to a contradiction to the alleged structure of the (P)-group G . Indeed, observe also that here $(|\mathbb{E}(G)|, |\mathbb{F}(G)|) = 1$ due to the (P)-property of G and look at the (P)-groups $G/\mathbb{F}(G)$ and $G/\mathbb{E}(G)$, each being smaller in order than $|G|$. Thus, by induction, no odd prime p dividing $|\mathbb{E}(G)\mathbb{F}(G)/\mathbb{F}(G)|$ divides $|G/\mathbb{E}(G)|$ and p does not divide $|\mathbb{F}(G)|$ too; whence $p \nmid \frac{|G|}{|\mathbb{E}(G)\mathbb{F}(G)/\mathbb{F}(G)|} = |G/\mathbb{E}(G)|$ as $\mathbb{E}(G)$ is here simple, contrary to the choice of G .

5) b) Let the (P)-group G satisfy the condition announced in 5) and assume also that $\mathbb{E}(G) = \{1\}$. Hence, as $\mathbb{F}(G)$ is a nontrivial abelian subgroup of G , one gets $1 \neq \mathbb{F}(G) \leq \mathbb{C}_G(\mathbb{F}(G)) = \mathbb{C}_G(\mathbb{F}(G)\mathbb{E}(G)) = \mathbb{C}_G(\mathbb{F}^*(G)) \leq \mathbb{F}^*(G) = \mathbb{E}(G)\mathbb{F}(G) = \mathbb{F}(G)$. Hence, $G/\mathbb{F}(G) \hookrightarrow \text{Aut}(\mathbb{F}(G))$. In particular, as G is assumed to be nonsolvable, $\mathbb{F}(G)$ cannot be a cyclic group of odd prime order. Therefore, in this rubric b) one works with a noncyclic but elementary abelian q -group $\mathbb{F}(G)$, with q an odd prime number. The group $\overline{G} := G/\mathbb{F}(G)$ acts like a subgroup of $\text{GL}(n, q)$, with $q^n = |\mathbb{F}(G)|$ and $n \geq 2$, on the n -dimensional vector space V over \mathbb{F}_q , by permuting transitively the nonzero vectors. Consider the group $\hat{G} := \overline{G}Z \in \text{GL}(n, q)$ with Z being the center of $\text{GL}(n, q)$; notice $|Z| = q - 1$ holds. Due to the CFSG and the fact that q is odd, we see that G satisfies the conclusion of the theorem, unless perhaps when \hat{G} is subject to one of the cases 1), 2), 4), 5), or 8) as listed in Hering's theorem. We are able to eliminate each of those five cases as follows.

(α) case 5) in Hering's theorem.

Here the final term \hat{G}^∞ of the derived series of \hat{G} has to be isomorphic to the group $\text{SL}(2, 5)$; moreover, $q \in \{3, 11, 19, 29, 59\}$ can be the only possibilities for such a q . Since $|\text{SL}(2, 5)| = 120 = 2^3 \cdot 3 \cdot 5$ and as the group G is a counterexample to the theorem (and $\overline{G} = G/\mathbb{F}(G)$ is not) only the prime $q = 3$ remains to be investigated. Now put $L \trianglelefteq G$ as the group satisfying $L\mathbb{F}(G)/\mathbb{F}(G) \cong \text{SL}(2, 5)$. Notice $\zeta(L\mathbb{F}(G)/\mathbb{F}(G)) = \mathbb{F}(G)\langle \tau \rangle / \mathbb{F}(G) \trianglelefteq G/\mathbb{F}(G)$ with $|\tau| = 2$ and $\tau \in G$. Such a τ exists as $|\mathbb{F}(G)\langle \tau \rangle| = 2 \cdot 3^4$. Suppose τ centralizes some subgroup $C \leq G$ of order 3. As G is a (P)-group, $C \leq \mathbb{F}(G)$ holds. Put $C = \langle c \rangle$ with $c \in \mathbb{F}(G)$. It follows for any $g \in G$ that $(g\tau g^{-1})(g c g^{-1})(g\tau g^{-1})^{-1} = g c g^{-1} \in \mathbb{F}(G)$. Moreover, we just observed that the involution $g\tau g^{-1}$ is an element of the coset $\tau\mathbb{F}(G)$ of $\mathbb{F}(G)$ in G . Since G is a (P)-group, all its cyclic subgroups of order 3 are contained in the elementary abelian 3-group $\mathbb{F}(G)$. Thus, for some specific $f \in \mathbb{F}(G)$, it holds that $g\tau g^{-1} = \tau f$, whence $\tau(g c g^{-1})\tau^{-1} = \tau(f(g c g^{-1})f^{-1})\tau^{-1} = (g\tau g^{-1})(g c g^{-1})(g\tau g^{-1})^{-1} = g c g^{-1}$. Therefore, as G is a (P)-group, one observes that in fact τ centralizes each element of the Fitting Subgroup $\mathbb{F}(G)$ of G . A contradiction to $\mathbb{C}_G(\mathbb{F}(G)) = \mathbb{F}(G)$ in the case 5) b) in which we did find ourselves. Hence, τ inverts any arbitrary element of $\mathbb{F}(G)$ by conjugation.

Let σ be any element of G outside $\mathbb{F}(G)$ with $\sigma^2 \in \mathbb{F}(G)$. Hence, $\mathbb{F}(G)\langle\tau\rangle = \mathbb{F}(G)\langle\sigma\rangle$, as $G/\mathbb{F}(G)$ is a (P)-group satisfying $\mathbb{F}(G)\langle\tau\rangle \trianglelefteq G$. Any element of $\mathbb{F}(G)\langle\tau\rangle$ outside $\mathbb{F}(G)$ is in fact an involution of $\mathbb{F}(G)\langle\tau\rangle$, as for any $f \in \mathbb{F}(G)$, $\tau f \cdot \tau f = (\tau f \tau^{-1})f = f^{-1}f = 1$ holds, so $|\sigma| = 2$. There exists an element $x \in L\mathbb{F}(G) \setminus \mathbb{F}(G)$ for which $|x\mathbb{F}(G)| = 6$, as $\tau\mathbb{F}(G)$ is an involution in $G/\mathbb{F}(G)$ lying in $\zeta(L\mathbb{F}(G)/\mathbb{F}(G))$ and as there elements in $G/\mathbb{F}(G)$ lying in $L\mathbb{F}(G)/\mathbb{F}(G)$ of order 3. We get $(x\mathbb{F}(G))^6 = \mathbb{F}(G)$, whence $x^{18} = 1$ holds. Suppose $x^6 \neq 1$ and $x^9 \neq 1$. Then x^9 is an involution of G centralizing the element $x^6 \in \mathbb{F}(G)$ of order 3; as we argued above, it does not occur. Suppose $x^6 \neq 1$ and $x^9 = 1$. Then the order of $x\mathbb{F}(G)$, which is 6, has to divide $9 = |x|$; an impossibility. Hence, we are left with $x^6 = 1$. As $|x\mathbb{F}(G)| = 6$ inside $G/\mathbb{F}(G)$, it holds that $x^2 \neq 1$ and that $x^3 \neq 1$. This implies though in the (P)-group G that the involution $x^3 \in G$ and the nontrivial element $x^2 \in \mathbb{F}(G)$ do centralize each other. This behavior was ruled out earlier, however. All this settles case 5) of Hering's theorem in the negative.

(β) case 8) in Hering's Theorem.

As in the last situation, look at $\hat{G} = \overline{G}Z \in \text{GL}(n, q)$, which is isomorphic to the nonabelian group $\text{SL}(2, 13)$ with $|\mathbb{F}(G)| = 3^6 = 729$. All proper subgroups of $\text{SL}(2, 13)$ are solvable, by ([6], page 8). Hence, \overline{G} has to be nonsolvable, as \hat{G} is. Thus, in fact $\overline{G} \cong \text{SL}(2, 13)$ and $\overline{G} \cong \hat{G}$ is a (P)-group. The rest of the elimination of the rubric is analogous to the one as done in case (α) just done.

(γ) case 4) in Hering's theorem.

Here $\hat{G} = \overline{G}Z \in \text{GL}(n, q)$ with $Z = \zeta(\text{GL}(n, q))$, and $E \triangleleft \overline{G}$ where E is an extra-special 2-group satisfying $\mathbb{C}_{\hat{G}}(E) = \zeta(E)$. Hence, $Z \leq \zeta(E)$. Then $\hat{G} = \overline{G}Z \leq \overline{G}\Phi(E) \leq \overline{G}\Phi(\hat{G}) \leq \hat{G}$ (inclusion (1) is due to $E \trianglelefteq G$). Thus, $\hat{G} = \overline{G}\Phi(\hat{G})$, i.e. $\hat{G} = \overline{G}$ by ([8], III. 2. Satz), so \hat{G} being equal to the (P)-group \overline{G} , does contain precisely one element of order 2, due to $|\zeta(E)| = 2$ and $\zeta(E) \trianglelefteq \overline{G}$. Hence, E , being an extra-special 2-group, must be of order 8, whence $E \cong Q$. Now it happens that $\overline{G}/\mathbb{C}_{\overline{G}}(E) \hookrightarrow \text{Aut}(E)$. It holds that $\text{Aut}(Q) \cong S_4$, the symmetric group on four symbols. Thus, it follows that $\overline{G}/\mathbb{C}_{\overline{G}}(E) = \overline{G}/\zeta(E)$ is solvable; whence \overline{G} is solvable and so G is solvable. This contradicts the assumption regarding the nonsolvability of the (P)-group G .

(δ) case 1) in Hering's theorem.

According to case 1), the insolvable group $\hat{G} = \overline{G}Z \in \text{GL}(n, q)$ satisfies, as \overline{G} is a (P)-group, $\text{SL}(a, u) \trianglelefteq \hat{G}$ with $q^n = u^a$, $a \geq 2$ and $|\mathbb{F}(G)| = q^n$. Now, as $\overline{G} \trianglelefteq \hat{G}$, it too holds that $\text{SL}(a, u) \trianglelefteq \overline{G}$; indeed the commutator subgroup of \hat{G} , being equal to that of \overline{G} , does contain $[\text{SL}(a, u), \text{SL}(a, u)]$ which is here equal to $\text{SL}(a, u)$. It has been shown earlier that, in order that \overline{G} be a (P)-group, only $a = 2$ must hold. Therefore, $\text{SL}(a, u) = \text{SL}(2, q^d)$ for a suitable integer $d \geq 1$. Thus, $\text{PSL}(2, q^d)$ is isomorphic to some nonabelian simple chief factor L/K of the (P)-group \overline{G} , whence of the (P)-group G . In the nonsolvable (P)-group G , there exists an element τ of order 2. As $\text{SL}(2, q^d) \trianglelefteq G/\mathbb{C}_G(\mathbb{F}(G)) = G/\mathbb{F}(G)$, we get that there exists in the (P)-group $G/\mathbb{F}(G)$ precisely one element of order 2, which is $\tau\mathbb{F}(G)$, as $|\mathbb{F}(G)|$ is odd. The (P)-group $G/\mathbb{F}(G)$ does contain elements of order q , as $\text{SL}(2, q^d)$ does. Now, analogously to the procedure followed in the discussion in case 5) it can be made clear that τ acts on

$\mathbb{F}(G)$ by conjugation by inverting each element of $\mathbb{F}(G)$. Thus, there exists an element $x \in G \setminus \mathbb{F}(G)$ for which $|x\mathbb{F}(G)| = 2q$; whence $x\mathbb{F}(G)$ is an element contained in the normal subgroup of the (P)-group \overline{G} corresponding to $SL(2, q^d)$, as \overline{G} is a (P)-group and as $[x\mathbb{F}(G), \tau\mathbb{F}(G)] = \{\overline{1}\}$. Anyway one has $x^{2q^2} = 1$. Hence, $x^{2q} \in \mathbb{F}(G)$. If $|x| = 2q^2$, then $[x^{q^2}, \tau] = 1$ so that $\tau\mathbb{F}(G) = x^{q^2}\mathbb{F}(G)$; whence the involution τ centralizes the nontrivial element $x^q \in \mathbb{F}(G)$ as $\mathbb{F}(G)$ is an elementary abelian q -group. A contradiction to what we saw above, namely τ has to invert all elements of $\mathbb{F}(G)$. If the order of x equals $2q$, then the involution x^q centralizes the element $x^2 \neq 1$ with $x^2 \in \mathbb{F}(G)$, an impossibility, as we argued above. The order of x cannot be 2, as $|x\mathbb{F}(G)| = 2q$. Also $|x| = q^2$ is impossible as $|x\mathbb{F}(G)| = 2q$. Hence, case 1) delivers a contradiction to the assumed structure of the (P)-group G .

(ϵ) case 2) in Hering's theorem.

One has here $|\mathbb{F}(G)| = q^n$ satisfying $n = km$, k an even number and $Sp(k, q^m)$ being isomorphic to a normal subgroup of $\hat{G} = \overline{G}Z \in GL(n, q)$. Hence, as \hat{G} is nonsolvable and due to ([1], page 400), it must be that $k = 2$. Hence, we are back in the discussion in one of the cases 1), 5) or 8), we already dealt with.

The proof of the theorem is complete. □

Remark 6.2 Notice that we could not use the knowledge of Theorem 5.7 into our proof of Theorem 6.1. Namely, the reader who dealt with the proof of Theorem 5.7, has been made aware that the knowledge of the (independent) Theorem 6.1 was needed.

7. (P)-groups admitting a chief factor isomorphic to A_5

In this section, the classification of the (P)-groups G admitting a chief factor $L/K \cong A_5$ will be presented. Currently, the symbol G will stand for such a group.

The classification will be provided in a series of steps. We conclude the section with an overall portman-teau theorem, in which the results are collected; see Theorem 7.1.

Let us look at $\mathbb{F}^*(G) = \mathbb{E}(G)\mathbb{F}(G)$. Remember $[\mathbb{E}(G), \mathbb{F}(G)] = \{1\}$. We distinguish two cases: α) $\mathbb{E}(G) \neq \{1\}$; β) $\mathbb{E}(G) = \{1\}$.

α) Assume $\mathbb{E}(G) \neq \{1\}$. Hence, $\mathbb{E}(G)/\zeta(\mathbb{E}(G)) \cong PSL(2, 5) \cong A_5$, see Theorem 2.3. Furthermore, the property $\mathbb{E}(G)' = \mathbb{E}(G)$ has to be considered. Hence, $\zeta(\mathbb{E}(G)) = \mathbb{E}(G)' \cap \zeta(\mathbb{E}(G))$ has order at most 2, due to ([11], 2.1.7 Theorem), as now $\zeta(\mathbb{E}(G)) \hookrightarrow \mathcal{M}(PSL(2, 5))$ which is of order 2. We distinguish two cases: $\alpha, 1$) $|\zeta(\mathbb{E}(G))| = 1$; $\alpha, 2$) $|\zeta(\mathbb{E}(G))| = 2$.

Re $\alpha, 1$) Assume $\mathbb{E}(G) = \mathbb{E}(G)'$ with $\zeta(\mathbb{E}(G)) \cong C_2$ and $\mathbb{E}(G)/\zeta(\mathbb{E}(G)) \cong PSL(2, 5)$. Therefore, $\mathbb{E}(G) \cong SL(2, 5)$ by ([10], XII. 8.3 Lemma) and ([8], V.25.7 Satz). Since $[\mathbb{E}(G), \mathbb{F}(G)] = \{1\}$ and as G is a (P)-group, G does contain precisely one involution. We get that all cyclic subgroups of order 4 have to be contained in the normal subgroup $\mathbb{E}(G)$ of G . It holds that $G/\zeta(\mathbb{E}(G))$ is a (P)-group, so one gets $\mathbb{F}(G) = \mathbb{O}_2(\mathbb{F}(G)) \times \mathbb{O}_{2'}(\mathbb{F}(G)) = \zeta(\mathbb{E}(G)) \times \mathbb{O}_{2'}(\mathbb{F}(G))$. Notice that $(|\mathbb{O}_{2'}(\mathbb{F}(G))|, |\mathbb{E}(G)|) = (|(\zeta(\mathbb{E}(G)) \times \mathbb{O}_{2'}(\mathbb{F}(G)))/\zeta(\mathbb{E}(G))|, |\mathbb{E}(G)/\zeta(\mathbb{E}(G))|) = 1$, as G is a (P)-group and as $\mathbb{E}(G) \cap (\zeta(\mathbb{E}(G)) \times \mathbb{O}_{2'}(\mathbb{F}(G))) = \zeta(\mathbb{E}(G))$. [Indeed, no prime dividing $|\mathbb{O}_{2'}(\mathbb{F}(G)) \times \zeta(\mathbb{E}(G))|$ divides 15 as G is a (P)-group]. Furthermore, $G/\zeta(\mathbb{E}(G))$ does now satisfy the promises of Theorem 5.4, i.e. there exists $\zeta(\mathbb{E}(G)) \leq H \leq G$

such that $H/\zeta(\mathbb{E}(G))$ is a (P)-group satisfying $G = \mathbb{E}(G)H$, $H \cap \mathbb{E}(G) = \zeta(\mathbb{E}(G))$, $\mathbb{E}(G)$ being a (P)-group, and $(|H/\zeta(\mathbb{E}(G))|, |\mathbb{E}(G)/\zeta(\mathbb{E}(G))|) = 1$. Since $2 \mid |\mathbb{E}(G)/\zeta(\mathbb{E}(G))|$ and $2 = |\zeta(\mathbb{E}(G))|$, it follows that $H = \zeta(\mathbb{E}(G))\tilde{H}$, where $\tilde{H} \trianglelefteq G$, $2 \nmid |\tilde{H}|$ and with $\tilde{H} \cong H/\zeta(\mathbb{E}(G))$ being a (P)-group. All in all, in $\alpha, 1)$, $G \cong \text{SL}(2, 5) \rtimes \tilde{H}$, where \tilde{H} is a solvable (P)-group. In fact, it even holds that G is isomorphic to a direct product of $\text{SL}(2, 5)$ and \tilde{H} , due to Re $\alpha, 2)$.

Re $\alpha, 2)$ Assume $\mathbb{E}(X) = \mathbb{E}(X)'$ with $\zeta(\mathbb{E}(X)) = \{1\}$, whence $\mathbb{E}(X) \cong \text{PSL}(2, 5)$ for some group X . Hence, one immediately gets from Theorem 5.4 that X is a (P)-group if and only if there exists a (P)-subgroup R of X satisfying $X = \mathbb{E}(X)R$ with $(|R|, 120) = 1$. Hence, one also has $X = \mathbb{E}(X) \times R \cong \text{PSL}(2, 5) \times R$. [As to a more detailed structure for such a (P)-group X , see Theorem 5.4].

Re $\beta)$ At last, let us assume $\mathbb{E}(G) = \{1\}$ where G is a (P)-group admitting a chief factor $L/K \cong \text{PSL}(2, 5) \cong A_5$. As it was observed earlier, $\mathbb{C}_G(\mathbb{F}(G)) = \mathbb{C}_G(\mathbb{E}(G)\mathbb{F}(G)) = \mathbb{C}_G(\mathbb{F}^*(G)) \leq \mathbb{F}^*(G) = \mathbb{E}(G)\mathbb{F}(G) = \mathbb{F}(G)$ holds. By Jordan-Zassenhaus-Hölder in conjunction to Theorem 2.3, we may assume $L = \mathbb{O}^\infty(G)$, i.e. the smallest normal subgroup of G whose quotient group with respect to G , is solvable. Thus, $K \trianglelefteq G$ can be found inside G with $L > K$ and with $L/K \cong \text{PSL}(2, 5)$. By Theorem 2.3, K is solvable. Since $K \neq \{1\}$ in this rubric $\beta)$, there exists a nontrivial elementary abelian chief factor K/M of G with $K > M$. We distinguish two cases: a) $K/M \cong C_p$, p odd prime; b) $K/M \cong C_2 \times C_2 \times \dots \times C_2$ with $4 \mid |K/M|$; c) $K/M \cong C_p \times C_p \times \dots \times C_p$ with $p^2 \mid |K/M|$, p an odd prime; d) $K/M \cong C_2$.

Re $\beta, a)$ Suppose $K/M \cong C_p$, p odd prime. Put $\bar{G} = G/M$, $\bar{L} = L/M$, and $\bar{K} = K/M$. Notice \bar{G} is a (P)-group. We have $\bar{G}/\mathbb{C}_{\bar{G}}(\bar{K}) \hookrightarrow C_{p-1}$ so $\mathbb{C}_{\bar{G}}(\bar{K}) \geq \bar{L}$ holds by the solvability of $\bar{G}/\mathbb{O}^\infty(\bar{G}) = \bar{G}/\bar{L}$. Thus, \bar{L} centralizes \bar{K} . Now $p \nmid 15$, due to Theorem 6.1. Hence, $\bar{L} \cong \text{PSL}(2, 5) \times C_p$, so there exists $\bar{U} \trianglelefteq \bar{G}$ with $\bar{L} \geq \bar{U} \geq \bar{K}$ satisfying $\bar{U}/\bar{K} \cong \text{PSL}(2, 5)$ and \bar{G}/\bar{U} solvable of order $p \cdot |\bar{G}/\mathbb{O}^\infty(\bar{G})| = |\bar{G}/\bar{L}|$. This is a contradiction to the choice of L as being the group $\mathbb{O}^\infty(G)$. Conclusion: Case $\beta, a)$ does not occur.

Re $\beta, b)$ Suppose $K/M \cong C_2 \times \dots \times C_2$ with $4 \mid |K/M|$. The bar convention as defined under Re $\beta, a)$ is used here too. Suppose for the moment that $\bar{G}/\mathbb{C}_{\bar{G}}(\bar{K})$ would be solvable. Here too \bar{G} is a (P)-group. Here one has $\bar{L}/\bar{K} \cong \text{PSL}(2, 5) \cong \text{PSL}(2, 4) \cong (\bar{L}/\bar{K})' = \bar{L}'\bar{K}/\bar{K} \cong \bar{L}'/(\bar{L}' \cap \bar{K})$. However, $\mathbb{O}^\infty(\bar{G}) = \bar{L} < \mathbb{C}_{\bar{G}}(\bar{K})$ yielding $\bar{L} = \bar{L}'$. Also, $\zeta(\bar{L}) = \bar{K}$ holds here. Hence, by Schur ([11], theorem 2.1.7), it holds that $|\zeta(\bar{L})| = |\bar{L} \cap \zeta(\bar{L})| = |\bar{L}' \cap \zeta(\bar{L})| \leq |\mathcal{M}(\bar{L}/\bar{K})| = |\mathcal{M}(\text{SL}(2, 5))| = 2$; a contradiction to $4 \mid |\bar{K}| = |\zeta(\bar{L})|$. Thus, one has that $\bar{G}/\mathbb{C}_{\bar{G}}(\bar{K})$ is not solvable. In addition, $\mathbb{C}_{\bar{G}}(\bar{K}) \cap \bar{L}$, being a normal subgroup of \bar{G} , can only be equal to \bar{L} or to \bar{K} by the simplicity of \bar{L}/\bar{K} . Just as argued a few lines ago, one is forced to assume $\mathbb{C}_{\bar{G}}(\bar{K}) \not\geq \bar{L}$. As a matter of fact we will show, below with $\check{G} \triangleright \check{L} > \check{K} \neq \{1\}$, $\check{K} \trianglelefteq \check{G}$, there does not exist a (P)-group \check{G} for which $\check{L}/(\mathbb{C}_{\check{G}}(\check{K}) \cap \check{L}) \cong \text{SL}(2, 5)$ and with \check{K} an elementary abelian 2-group but not a chief factor of \check{G} being isomorphic to C_2 . Indeed, assume the contrary. By Jordan-Hölder, we are immediately allowed to assume that $\mathbb{F}(\check{G})$ is a 2-group. [In fact, factor out by $\mathbb{O}_{2'}(\mathbb{F}(\check{G})) \neq 1$, recall that $\check{G}/\mathbb{O}_{2'}(\mathbb{F}(\check{G}))$ is a (P)-group, apply Jordan-Hölder, use induction and use Re $\alpha)$]. Notice also that no such \check{G} can be a (P)-group occurring in the class Re $\alpha)$. In other words, $\mathbb{E}(\check{G}) = \{1\}$ holds and so $\mathbb{C}_{\check{G}}(\mathbb{F}(\check{G})) \leq \mathbb{F}(\check{G})$ will be the case. Look at $\mathbb{F}(\check{G})/\Phi(\mathbb{F}(\check{G}))$. Since $\mathbb{F}(\check{G})$ is supposed to be noncyclic,

$\mathbb{F}(\check{G})/\Phi(\mathbb{F}(\check{G}))$ is noncyclic (by Burnside's Basis Theorem), whence also $\mathbb{F}(\check{G})/\Phi(\mathbb{F}(\check{G}))$ is an elementary abelian 2-group. The 2-group $\Phi(\mathbb{F}(\check{G}))$ is a characteristic subgroup of $\mathbb{F}(\check{G})$. Hence, by induction, we may assume $\Phi(\mathbb{F}(\check{G})) = \{1\}$, i.e. $\mathbb{F}(\check{G})$ itself is an elementary abelian 2-group, but not cyclic, so that now $\mathbb{C}_{\check{G}}(\mathbb{F}(\check{G}))$ coincides with $\mathbb{F}(\check{G})$. By Hering's theorem, there exists now $\mathbb{F}(\check{G}) \leq \check{U} \leq \check{G}$ satisfying $\check{U}/\mathbb{F}(\check{G}) \cong \text{SL}(2, 4) \cong \text{A}_5$. The discussion and details at the end of the proof of Theorem 5.5 do also apply here. Thus, the outcome is that \check{G} cannot be a (P)-group. Hence, the case $\beta, b)$ does not occur.

Re $\beta, c)$ Suppose $K/M \cong C_p \times C_p \times \dots \times C_p$ with $p^2 \mid |K/M|$ and p an odd prime. Since G is a nonsolvable (P)-group, it is known that $(|G/K|, p) = 1$; see Theorem 5.7. Put $\bar{G} := G/M$, $\bar{L} := L/M$, $\bar{K} := K/M$. Since $L/K \cong \text{PSL}(2, 5)$, $\mathbb{O}^\infty(G) = L$, the Schur multiplier of $\text{PSL}(2, 5)$ being of order 2. All this, when combined with $p \nmid |\bar{G}/\mathbb{C}_{\bar{G}}(\bar{K})|$, after consulting Hering's theorem, provide that case $\beta, c)$ does not occur, i.e. G cannot be a (P)-group in this rubric Re $\beta, c)$.

Re $\beta, d)$ Therefore, the only possibility for the structure of K/M is $K/M \cong C_2$. Thus, as G/M is a (P)-group, it follows from $\mathbb{O}^\infty(G) = L$, that $L/M \cong \text{SL}(2, 5)$ with $\zeta(L/M) = K/M \cong C_2$. Since we are not in case Re $\alpha) 2)$, one gets $M \neq \{1\}$. Let $N \trianglelefteq G$ such that $M > N$ with M/N a chief factor of G . Therefore, four possibilities of structures have to be considered for M/N . Namely: d) α) $M/N \cong C_2$; d) β) $M/N \cong C_p$, p odd prime; d) γ) $M/N \cong C_2 \times C_2 \times \dots \times C_2$ with $4 \mid |M/N|$; d) δ) $M/N \cong C_p \times C_p \times \dots \times C_p$ with p odd prime and $p^2 \mid |M/N|$.

Re $\beta, d), \alpha)$ Suppose $M/N \cong C_2$. The group G/N is a (P)-group. Thus, G/N happens to contain precisely one subgroup of order 2, namely M/N . Hence, any Sylow 2-subgroup S of L/N , S being of order 16, must be generalized quaternion, as S is not cyclic due to $S/M \in \text{Syl}_2(L/M)$ being noncyclic; see ([8] III. 2b Satz). On the other hand, S/M viewed as a factor group of S/N with $\zeta(S/N) = M/N$ is dihedral of order 8. Then, however, the last mentioned structure is in conflict with the actual structure of any Sylow 2-subgroup of $\text{SL}(2, 5)$, namely quaternion of order 8, where $\text{SL}(2, 5) \cong L/M$. Hence, case d) α) does not occur.

Re $\beta, d), \beta)$ Suppose $M/N \cong C_p$, p odd prime. Then $\mathbb{C}_{G/N}(M/N) \geq L/N$, as $\mathbb{O}^\infty(G) = L$ and $(G/N)/\mathbb{C}_{G/N}(M/N) \hookrightarrow \text{Aut}(C_p) \cong C_{p-1}$, a solvable group. Thus, $M/N \leq \zeta(L/N)$, where also $p \nmid |L/M| = 120$ due to Theorem 6.1. Hence, M/N is a characteristic and critical subgroup of L/N of order p satisfying $p \nmid (L/N)/(M/N)$, so there would exist $T/N \trianglelefteq G/N$ with $T \trianglelefteq G$ and $T \trianglelefteq K$ and $|L/T| = p$, yielding the solvability of G/T by $\mathbb{O}^\infty(G) = L$, thereby producing at the same time the contradiction $T \geq L$. Therefore, the case d) β) does not happen.

Re $\beta, d), \gamma)$ Suppose $M/N \cong C_2 \times C_2 \times \dots \times C_2$ with $4 \mid |M/N|$. Look at the 2-group K/N , where $K > M$ and $|K/M| = 2$. The group G/N is a (P)-group, thus permuting the nontrivial elements $\neq 1$ of M/N transitively. This forces the Frattini subgroup $\Phi(K/N)$ of K/N to be equal either to $N/N = \{1\}$ or to M/N . [Indeed, $M/N \not\cong \Phi(K/N) \not\cong N/N = \{1\}$ leads via the (P)-group $(G/N)/\Phi(K/N)$ to the fact that not only $(G/N)/\Phi(K/N)$ is an elementary abelian 2-group of order at least 4, whose nontrivial elements are permuted transitively under conjugation, but also to the structure $K \overset{2}{>} M > \Phi > N$ with $\Phi \trianglelefteq G$ with $\Phi/N := \Phi(K/N)$ and $M \trianglelefteq G$. Both these properties are in conflict with each other in the (P)-group G].

If $\Phi(K/N) = N/N = \{1\}$, then K/N would be an elementary abelian 2-group whose nontrivial elements of order 2 are permuted transitively under conjugation in the (P)-group G/N , a contradiction to the existence of $M/N \trianglelefteq G/N$ with $M/N \neq K/N$. If $\Phi(K/N) = M/N$, then by Burnside's Basis Theorem K/N would be cyclic, yielding $|M/N| = 2$, which is not the case. Therefore, the case d) γ) does not happen.

Re $\beta, d), \delta)$ Assume $M/N \cong C_p \times C_p \times \dots \times C_p$, p odd prime, $p^2 \mid |M/N|$. Look at the text just after the ending of the proof of Theorem 5.7, where we now focus our attention on the (P)-group $\tilde{G} := G/N$. It was argued there, by now inserting the assumption $\mathbb{O}^\infty(\tilde{G}) = L/N$, that M/N is elementary abelian of order 11^2 or 19^2 or 29^2 or 59^2 and satisfies $M/N \not\leq \zeta(\tilde{G})$ too.

Suppose there exists a cyclic Sylow q -subgroup of G for some odd prime q , satisfying $q \mid |M|$ with $q \nmid 11 \cdot 19 \cdot 29 \cdot 59 \cdot 3 \cdot 5$. Choose a chief factor V/W in some chief series in G passing through M , as "high as possible". Thus, $|V/W| = q$, and also $(G/W)/\mathbb{C}_{G/W}(V/W)$ is solvable with order dividing $q-1$. Since $L/W = \mathbb{O}^\infty(G)/W \leq \mathbb{C}_{G/W}(V/W)$ holds now, it follows that V/W is a direct factor of M/W satisfying $q \nmid |M/V|$. Hence, there exists $D \trianglelefteq G$ with $M \geq D \geq W$ and $|M/D| = q$. This, however, was already ruled out by case d) β). Such a structure as described in this paragraph does not exist.

Let us now consider an odd prime t not dividing 15, for which there exists $S_t \in \text{Syl}_t(G)$ not being cyclic. Then $S_t \trianglelefteq \mathbb{F}(G)$, by Corollary 5.8 satisfying $\text{PSL}(2, 5) \not\cong \text{PSL}(2, r^m)$ with r odd prime and $m \geq 2$ due to ([1], page 466), and by Theorem 2.3 using Jordan-Zassenhaus-Hölder. Furthermore, such $S_t \trianglelefteq \mathbb{F}(G)$ is in fact elementary abelian. In particular, let us focus our attention on $r \in \{11, 19, 29, 59\} =: A$ for which S_r exists, and for any such r define $\tilde{F} := \prod_{i=1}^4 (C_{p_i} \times C_{p_i})^{\delta_i}$ with $\delta_i \in \{0, 1\}$, where $p_i \in A$. Notice $\tilde{F} \neq \{1\}$ anyway in this rubric d) δ), as we saw above. Remember that any odd prime f dividing $|K|$ satisfies $(f, 15) = 1$ as $2^3 \cdot 3 \cdot 5 = |\text{PSL}(2, 5)|$ in conjunction to Theorem 6.1.

Let t be an odd prime dividing $|K|$. Hence, $t \nmid 15$ by Theorem 6.1.

Assume for the moment that for some specific such a t , each chief factor C/F of G with $M \geq C > F$ being a t -group is cyclic (whence $|C/F| = t$). Then, using an analogous procedure as described three paragraphs ago, it turns out that such a structure does not happen, due to the (P)-property of G .

Next assume that for such an odd prime t with $t \nmid 15$, t dividing $|K|$, there exists a noncyclic chief factor X/B of G with $M \geq X > B$ of t -power order. Then we saw, due to the (P)-property of G , that G has t -length 1 for such a t ; note that X/B is elementary abelian.

Therefore, it follows from the nonexistence of the cases d) α) and d) γ) that M is nilpotent of odd order, and therefore satisfies $M = \tilde{F}$, in this rubric d) δ). [Indeed, for a $p_i \in A$, let $S := \prod_{p_i} S_{p_i}$ where (if any) S_{p_i} is noncyclic elementary p_i -group, i.e. $\{S_{p_i}\} = \text{Syl}_{p_i}(G)$. Then, as it was observed above, M/S might only have cyclic chief factors (ruled out by d) β) or M/S might have 2-groups as chief factors (ruled out by d) α) and d) γ)].

Next, we are going to analyze what happens if $M = \tilde{F}$ contains $S \trianglelefteq G$ where $S \cong C_{11} \times C_{11}$ and $\{S\} = \text{Syl}_{11}(G)$. Put $C = \mathbb{C}_G(S)$; thus, $C \trianglelefteq G$. One has $M \leq C \trianglelefteq G$. Since G/M is a (P)-group containing $L/M = \mathbb{O}^\infty(G)/M \trianglelefteq G/M$ with $L/M \cong \text{SL}(2, 5)$, one observes that G/M does contain only

one involution \bar{t} (say), where $\langle \bar{t} \rangle = K/M$. It also holds that $C/M \cap L/M = \{1\}$. Therefore, C/M is of odd order.

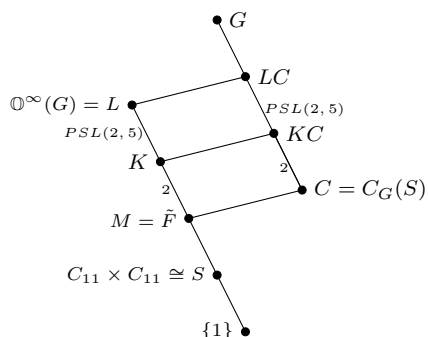

Look at the diagram as pictured. Since $|C/M|$ is odd, and the prime factors of $|C/M|$ are relatively prime to $15 = (\text{odd part of } |L/M|)$, it is appropriate to look at the direct product $LC/M = L/M \times C/M$. One has $LC/C \cong \text{SL}(2, 5)$ with $\zeta(LC/C) = KC/C$. Now G/C embeds as a subgroup in $\text{Aut}(C) \cong \text{GL}(2, 11)$. The order of $\text{GL}(2, 11)$ is $(11^2 - 1)(11^2 - 11) = 2^4 \cdot 3 \cdot 5^2 \cdot 11$.

Since $S \leq C$ is the Sylow 11-subgroup of G , it holds that $11 \nmid |G/C|$. One has also $|LC/C| = 120 = 2^3 \cdot 3 \cdot 5$. In Theorem 6.1, it is proved implicitly that $(|G/L|, 15) = 1$. It means that $5 \nmid |G/LC|$, whereas $5 \mid |LC/C|$ and $5 \mid |G/C|$ do hold. It follows that $|G/LC|$ is a divisor of 2. Let us consider the structure of G/KC ; notice $KC \trianglelefteq G$ and $LC \trianglelefteq G$. The (P)-group G/KC contains LC/KC as a normal subgroup satisfying $2 \geq |G/LC| = |(G/KC)/(LC/KC)|$. Look at the structure of a Sylow 2-subgroup of G/C and of a Sylow 2-subgroup of LC/C as well. Since G/C is a (P)-group containing a nonabelian Sylow 2-subgroup of LC/C with $\zeta(LC/C) \triangleleft G/C$ and $|\zeta(LC/C)| = 2$, it holds that $\text{Syl}_2(G/C)$ consists of generalized quaternion groups, whereas LC/C , being isomorphic to $\text{SL}(2, 5)$, does contain Sylow 2-subgroups isomorphic to Q . Such a structure is impossible when $2 = |G/LC|$; see ([8], III.8.2 Satz and I.14.9(2) Satz). Hence, $G = LC$.

Precisely, the same phenomenon happens when $M = \tilde{F}$ contains $\tilde{S} := C_{19} \times C_{19}$. Direct calculations on the orders of $|\text{SL}(2, 5)|$ and $\text{Aut}(C_{19} \times C_{19})$ provide that the order of the quotient group G/LC is at most equal to 2, whence in fact equal to 1 due to a reasoning analogous to the “ $C_{11} \times C_{11}$ ”-case.

On the other hand, if $M = \tilde{F}$ contains a subgroup \bar{S} isomorphic to $C_{29} \times C_{29}$ (so $\{\bar{S}\} = \text{Syl}_{29}(G)$ as we know), then at first sight one gets the corresponding quotient group G/LC is of order dividing $2^2 \cdot 7^2$. The “quaternion argument” reduces it to $|G/LC| \mid 7^2$. Here it will turn out that either $G = LC$ or $|G/LC| = 7$ can occur in practice. [Indeed, $(C_{29} \times C_{29}) \rtimes \text{SL}(2, 5)$ and $(C_{29} \times C_{29}) \rtimes (\text{SL}(2, 5) \times C_7)$ are both Frobenius groups, even better, in each such group it happens that any two subgroups of equal order are conjugate within the corresponding over group; see ([3], Theorem 11)]. Notice that the (P)-group property of G/C yields indeed that, if $|G/LC| = 7$, G/C is isomorphic to the group $\text{SL}(2, 5) \times C_7$. As for $|G/LC| \neq 7^2$, see later.

Finally, if $M = \tilde{F}$ contains a subgroup $\bar{\bar{S}}$ isomorphic to $C_{59} \times C_{59}$ so $\{\bar{\bar{S}}\} = \text{Syl}_{59}(G)$, then one gets $|G/LC| = 1$ or $|G/LC| = 29$ ultimately. Both might occur. [Indeed, in ([3], Theorem 11) one can find that there exist Frobenius groups isomorphic to $(C_{59} \times C_{59}) \rtimes \text{SL}(2, 5)$ or $(C_{59} \times C_{59}) \rtimes (\text{SL}(2, 5) \times C_{29})$; both these groups share the conjugacy property as mentioned just in the analogous “ $C_{29} \times C_{29}$ ”-case]. Notice, however, that at first sight, one does observe that $|G/LC|$ is a divisor of 29^2 .

[Here we provide the reason, because in the “ $C_{29} \times C_{29}$ ”-case, $|G/LC| = 7^2$ is ruled out, and because in the “ $C_{59} \times C_{59}$ ”-case, $|G/LC| = 29^2$ is ruled out. Well let $t \in \{7, 29\}$ in the respective cases.

Remember that $GL(2, 29)$ possesses indeed noncyclic Sylow 7-subgroups of order 7^2 ; see ([8],II.7.2(a) Satz). Likewise $GL(2, 59)$ possesses noncyclic Sylow 29-subgroups of order 29^2 . Therefore, if t^2 were equal to $|G/LC|$, then a Sylow t -subgroup T of G would be noncyclic. In that case, $T \leq \mathbb{F}(G)$ would hold by Corollary 5.8. Hence, T acts trivially on \bar{S} and $\overline{\bar{S}}$ respectively by conjugation, an impossibility].

Thus, perhaps there does exist a cyclic Sylow t -subgroup of order t^2 in G/LC .

In general, let us focus our attention on $\tilde{F} = M \cong \prod_{i=1}^4 (C_{p_i} \times C_{p_i})^{\delta_i}$, with $p_1 = 11, p_2 = 19, p_3 = 29, p_4 = 59$ and $\delta_i \in \{0, 1\}$ ($i = 1, 2, 3$ or 4), but not all δ_i equal to zero. Let $M_i \trianglelefteq M$ for which there exists a quotient group M/M_i isomorphic to $C_{p_i} \times C_{p_i}$; notice that $M_i \trianglelefteq G$ too. There exists an isomorphic embedding of G into the direct product of the corresponding factor groups G/M_i , see ([8],I.11.9 Satz). In case G/M_1 exists, then $G/M_1 \cong ((C_{11} \times C_{11}) \rtimes SL(2, 5)) \times U_1$, where U_1 is a solvable (P)-group satisfying $(|U_1|, 2 \cdot 3 \cdot 5 \cdot 11) = 1$. In case G/M_2 exists, then $G/M_2 \cong ((C_{19} \times C_{19}) \rtimes SL(2, 5)) \times U_2$, where U_2 is a solvable (P)-group satisfying $(|U_2|, 2 \cdot 3 \cdot 5 \cdot 19) = 1$. In case G/M_3 exists, then $G/M_3 \cong ((C_{29} \times C_{29}) \rtimes SL(2, 5)) \times U_3$, where U_3 is a solvable (P)-group satisfying $(|U_3|, 2 \cdot 3 \cdot 5 \cdot 29) = 1$, or else $G/M_3 \cong ((C_{29} \times C_{29}) \rtimes SL(2, 5)) \rtimes U\langle c \rangle$, where $|c| = 7^\alpha$ ($\alpha \geq 1$) with $U \triangleleft U\langle c \rangle$ and $c^7 \in U$, U acting trivially on $(C_{29} \times C_{29}) \rtimes SL(2, 5)$, $U\langle c \rangle$ a solvable (P)-group, c acting nontrivially on $C_{29} \times C_{29}$ and trivially on $SL(2, 5)$, where the action is conjugation of course; notice $(|U\langle c \rangle|, 2 \cdot 3 \cdot 5 \cdot 29) = 1$. In case G/M_4 exists, then change everywhere in the “ G/M_3 ” case 29 into 59, and 7 into 29. Hence, the structure of the $(\beta)d)\delta$ - case has been elucidated, as in the above considerations $[\tilde{F} \rtimes SL(2, 5), \tilde{F}] = \tilde{F}$ was treated implicitly.

Herewith the classification of the nonsolvable (P)-groups admitting a chief factor isomorphic to A_5 has been completed.

Let us collect the results obtained above into the following portmanteau theorem.

Theorem 7.1 *Let G be a group admitting a chief factor isomorphic to A_5 , the alternating group on five symbols. Then the following holds.*

The group G is a nonsolvable (P)-group, if and only if one of the next three structures is in vogue.

- 1) $G \cong SL(2, 5) \times H$, H being a solvable (P)-group such that $(30, |H|) = 1$;
- 2) $G \cong PSL(2, 5) \times H$, H being a solvable (P)-group such that $(30, |H|) = 1$;
- 3) $G = VW$, $V \trianglelefteq G$, $W \leq G$, $(|V|, |W|) = 1$, W a metacyclic (P)-group or W cyclic or $W = \{1\}$; $V = UT$, $U \trianglelefteq G$, $T \trianglelefteq G$, $(|U|, |T|) = 1$; T nilpotent noncyclic elementary abelian Sylow t subgroups whenever t is a prime dividing $|T|$;
 TW a solvable (P)-group; $[[W, W], U] = \{1\}$; $U = FS$ with $S < G$, $F \trianglelefteq G$, $S \cong SL(2, 5)$, $U = [U, U]$, $[U\zeta(S), U\zeta(S)] = U$, $F \cong \prod_{j=1}^4 (C_{p_j} \times C_{p_j})^{\delta_j}$ where $\delta_j \in \{0, 1\}$ with $j \in \{1, 2, 3, 4\}$ but not with all $\delta_j = 0$; $p_1 = 11, p_2 = 19, p_3 = 29, p_4 = 59$. \square

Therefore, the classification of all the nonsolvable (P)-groups has been completed too.

References

- [1] Artin E. The orders of the classical simple groups. *Communications on Pure and Applied Mathematics* 1955; 8: 455-472. doi: 10.1002/cpa.3160080403
- [2] Aschbacher M. *Finite Group Theory*. Cambridge Studies in Advanced Mathematics 10, Cambridge University Press; Cambridge, 1986.
- [3] Bensaïd A, Van Der Waall RW. Non-solvable finite groups whose subgroups of equal order are conjugate. *Indagationes Mathematicae* 1990; New Series 1: 397-408. doi:10.1016/0019-3577(90)90008-B
- [4] Berkovich Y, Janko Z. *Groups of Prime Power Order*. De Gruyter Expositions in Mathematics 3 56; W. de Gruyter Verlag, Berlin, 2011.
- [5] Carmichael RD. *Introduction to the Theory of Groups of Finite Order* Dover Publications, Inc, 1956.
- [6] Wilson R, Conway J, Norton S. *ATLAS of Finite Groups*. Oxford University Press; Oxford 1985.
- [7] Dickson LE. *Linear Groups with an Exposition of the Galois Field Theory*; Dover Publications, Inc, 1958.
- [8] Huppert B. *Endliche Gruppen I*. *Grundlehren der Mathematischen Wissenschaften* 134; Springer-Verlag, Berlin 1979.
- [9] Huppert B, Blackburn N. *Finite Groups II*; *Grundlehren der Mathematischen Wissenschaften* 242; Springer-Verlag, Berlin 1982.
- [10] Huppert B, Blackburn N. *Finite Groups III*; *Grundlehren der Mathematischen Wissenschaften*, 243; Springer-Verlag, Berlin 1983.
- [11] Karpilovsky G. *The Schur Multiplier*. London Mathematical Society Monographs, New Series, 2; Clarendon Press, Oxford 1987.
- [12] Lucchini A, Menegazzo F, Morigi M. On the existence of a complement for a finite simple group in its automorphism group. *Illinois Journal of Mathematics* 2003; 47: 395-418. doi: 10.1215/ijm/1258488162
- [13] Pandya GN. On automorphisms of finite simple Chevalley groups. *Journal of Number Theory* 1974; 6: 171-184. doi: 10.1016/0022-314X(74)90011-0
- [14] Sezer S. On finite solvable groups whose cyclic p -subgroups of equal order are conjugate. *Journal of Algebra* 2014; 415: 214-233. doi: 10.1016/J.JALGEBRA.2014.06.014
- [15] Sezer S, Van Der Waall RW. Finite groups all of whose abelian subgroups of equal order are conjugate. *Turkish Journal of Mathematics* 2006; 30: 139-175.
- [16] Suzuki M. *Group Theory I*. *Grundlehren der Mathematischen Wissenschaften* 247; Springer-Verlag, Berlin, 1982.
- [17] Van Der Waall RW. Finite groups whose subgroups of equal order are conjugate. *Indagationes Mathematicae (New Series)* 1993; 4: 239-254. doi: 10.1016/j.indag.2012.02.009
- [17a] Van Der Waall RW. The classification of finite groups whose subgroups of equal order are conjugate. *Indagationes Mathematicae (New Series)* 2013; 23: 448-478 and *Indagationes Mathematicae (New Series)* 24: 489-490. doi: 10.1016/j.indag.2012.02.009
- [17b] Van Der Waall RW. The classification of finite groups whose supersolvable (nilpotent) subgroups of equal order are conjugate. *Indagationes Mathematicae (New Series)* 2015; 26: 380-383. doi:10.1016/j.indag.2014.12.001
- [18] Van Der Waall RW, Bensaïd A. On finite groups whose elements of equal order are conjugate. *Simon Stevin: A Quarterly Journal of Pure and Applied Mathematics* 1991; 65: 361-374.
- [19] Yamaki H. The order of a group of even order. *Proceedings of the American Mathematical Society* 2008; 136: 1365-1375. doi: 10.1090/S0002-9939-07-09118-6