

1-1-2005

Examination of Some Organic Explosives by Ion Mobility Spectrometry (IMS)

HÜLYA KOYUNCU

ERTAN SEVEN

AYLA ÇALIMLI

Follow this and additional works at: <https://journals.tubitak.gov.tr/chem>

 Part of the [Chemistry Commons](#)

Recommended Citation

KOYUNCU, HÜLYA; SEVEN, ERTAN; and ÇALIMLI, AYL (2005) "Examination of Some Organic Explosives by Ion Mobility Spectrometry (IMS)," *Turkish Journal of Chemistry*. Vol. 29: No. 3, Article 5. Available at: <https://journals.tubitak.gov.tr/chem/vol29/iss3/5>

This Article is brought to you for free and open access by TÜBİTAK Academic Journals. It has been accepted for inclusion in Turkish Journal of Chemistry by an authorized editor of TÜBİTAK Academic Journals. For more information, please contact academic.publications@tubitak.gov.tr.

Examination of Some Organic Explosives by Ion Mobility Spectrometry (IMS)

Hülya KOYUNCU^{1*}, Ertan SEVEN², Ayla ÇALIMLI³

¹ *Yüzüncü Yıl University, Faculty of Agriculture, Department of Food Engineering, 65080 Van-TURKEY*

e-mail: hulko06@operamail.com

² *Police Criminal Laboratory, Bakanlıklar, Ankara-TURKEY*

³ *Ankara University, Faculty of Engineering, Department of Chemical Engineering, 06100 Tandoğan, Ankara-TURKEY*

Received 10.02.2004

The increase in terrorist activities committed using explosives in recent years has generated the need for improved analytical methods that can accurately and quickly identify explosives and their residues. In this study such an analytical method is evaluated. In the first phase of the study, standard solutions and a standard mixture solution of TNT (2,4,6-trinitrotoluene), RDX (1,3,5-trinitro-1,3,5-triazocyclohexane), PETN (pentaerythritol tetranitrate) and TETRYL (2,4,6-trinitrophenylmethylnitramine) were examined using ion mobility spectrometry (IMS). In the second phase, qualitative analysis of a real explosion residue was carried out and the explosive material used in the bomb was identified by analysing the acetone extract. In the third phase, a handswab sample taken from a suspect was analysed for trace explosive residues. Some advantages of using IMS for the detection of explosives and their residues were determined.

Key Words: Explosives, ion mobility spectrometry, trace explosive evidence, criminalistics.

Introduction

Modern instrumental analytical chemistry can be divided into 2 distinct categories. The first comprises very powerful and versatile laboratory instrumentation designed for fixed-facility use and for the detailed analysis of complex mixtures such as GC/MS, GC/FTIR, Tandem MS (MS/MS), and the second involves portable or easily transportable devices intended for field use for the detection of specific target compounds such as ion mobility spectrometry (IMS).

IMS, once referred to as plasma chromatography, is an analytical technique which began development in the late 1960s¹⁻². In any IMS system, ionised gas molecules are separated according to their mobility as they drift through gas at atmospheric pressure whilst under the influence of an electric field. The principles of operation of IMS systems have been described thoroughly elsewhere³⁻⁴⁻⁵; therefore only a brief description

*Corresponding author

of the construction and principles of operation will be presented here. An IMS system is shown schematically in Figure 1.

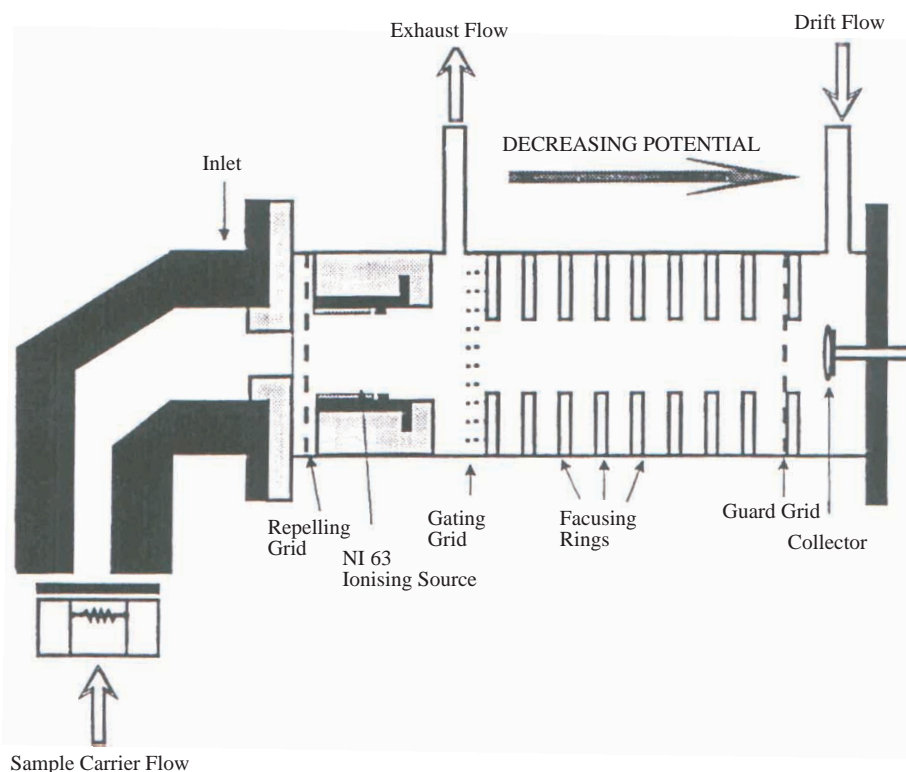
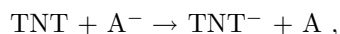

Figure 1. Schematic representation of an IMS detector cell.

The first requirement of an IMS system is a suitable ion source. The source is typically a beta emitter (most commonly Ni^{63}). In a dry air system the ionic species generated are pre-dominantly N_2^+ or O_2^+ positive ions and O_2^- negative ions. These ions are referred to as reactant ions. When molecules of the sample species are introduced into the ion source region these molecules will interact with the reactant ions and, assuming they have a greater affinity for the associated charge, a charge transfer will take place creating ions of the sample species. Other mechanisms are also possible to create characteristic product ions, such as the formation of adduct ions⁶.

These ions will, to varying degrees, cluster with water molecules, creating more complex cluster ions, depending on temperature and humidity levels. Thus $\text{O}_2(\text{H}_2\text{O})^-$, $\text{O}(\text{H}_2\text{O})^-$ and perhaps some NO_2^- ions are formed, and these interact with the sample ions. For example, TNT will undergo charge transfer reactions,



RDX gives ion-molecule reactions with the reactant ions,

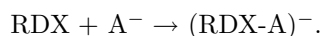

The reduced ion mobility times correspond to the molecular weights of the addition compounds [$\text{RDX-O}(\text{H}_2\text{O})^-$, [RDX-O_2^-] etc⁷⁻⁸. Therefore, the resultant IMS plasmagram of RDX contains 4 distinct peaks.

These ionic species will then move toward the ion gate under the influence of the extracting electric field. The polarity of the latter controls, whether positive or negative ions, is detected. Explosive substances form negative ions, while most narcotics, like heroin and cocaine, form positive ions⁹.

In the drift region the sample ions move under the influence of the applied electric field. Due to the collision between the sample ions and the drift gas molecules, separation takes place depending on the mobility of the sample ions. Ions with a higher mobility traverse the length of the drift region in a shorter time than ions with a lower mobility. The mobility of the ions will depend on their size, mass and shape. Hence, for each opening of the electronic gate, a pulse of electronic charge representing different ionic species in the sample will arrive at the ion collector separated in time. This ion current spectrum is referred to as a plasmagram.

The detailed theory of mobility has been discussed elsewhere¹⁰⁻¹¹ and will not be presented here. It should be noted here that the mobility of ionic species is defined by

$$V_d = KE \quad (1)$$

where V_d : drift velocity, K : the mobility of the species and E : electric field gradient.

$$K = d/E_t \quad (2)$$

d : drift region length (cm) and E_t : drift time (s).

The mobility of an ion will be to a first order approximation, a linear function of temperature and pressure. The reduced mobility K_0 is defined as follows, being the first order contributions of pressure and temperature normalised out:

$$K_0 = K(273/T)(P/760) \quad (3)$$

where T : absolute temperature and P : pressure in torr.

For known temperature and pressure characteristics in the IMS system, sample ions can be identified through measurement of their drift time in a drift tube of known length and electric field¹².

Identification of the type of explosive involved in terrorist bombings is often a vital clue for police forces trying to capture the perpetrators. Post-detonation debris contains residues of unexploded materials which have to be sorted out from innocent debris. The analysis may provide the link between a suspect and the type of explosive used.

Contamination of the hands has been shown to occur after handling commercial and military explosives. IMS can be used to identify explosives on suspects or on their belongings. This evidence can provide probable cause for a search warrant, help in identifying a potential terrorist, and locate concealed explosives¹³⁻¹⁸.

Experimental

In the first phase of this study, standard solutions of TNT, RDX, PETN and TETRYL obtained from the Mechanical and Chemical Industries Corporation were analysed. Standard solutions and a standard mixture solution were prepared for developing a method. The concentrations of the standards are shown in Table 1. The standards were weighed into 2 mL amber vials and were dissolved with 1 mL of acetone, and then the vials were placed into an ultrasonic bath for effective dissolution for 10 min.

Table 1. The concentrations of the explosive standards used for method development.

Explosives	Concentrations (mg/mL)	
	Standard Solutions	Mixture Solution
TNT	4.3	3.0
RDX	23.1	20.5
PETN	63.3	28.0
TETRYL	3.2	1.6

In the second phase of the study, an extraction method was developed for the qualitative analysis of real explosion residue. The sample was collected by the crime team from Gendarmerie Headquarters in Van and analysis was carried out at the Van region Gendarmerie Crime Laboratory (Figure 2). The sample was placed into a 1 L glass jar, mixed with acetone and shaken using an orbital shaker (Stuart Scientific) for 1 h and then filtered. Organic explosives were thus extracted into an acetone phase. The extract was concentrated by heating at low temperatures (40-50 °C). Because of the decomposition of the explosives, high temperatures were avoided.



Figure 2. Post-blast residue sample.

In the third phase of the study, a handswab from a person who handled the American made bomb (M26) for a few minutes was taken using a DC remote sampler for 20 s.

A Barringer Instruments Ionscan 400 (IMS) and its apparatus were used for all the experiments. First 0.1 μL each of standard solutions, standard mixture solution and concentrated acetone extract was applied on filters using a microlitre syringe and allowed to wait for 2 min for the complete evaporation of the solvent. A sample cartridge consists of 3 parts, a fibreglass filter, a ring and a card (Figure 3). The cartridges are inserted into the slide in front of the detector module, and the slide is moved to the right and then analysed.

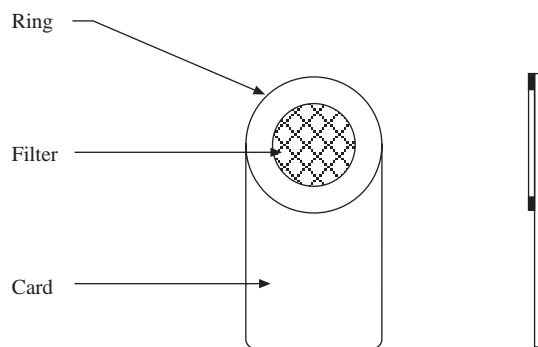

Figure 3. The sampling cartridge.

IMS is operated in negative ion mode. The instrument conditions for these experiments are shown in Table 2. Total analysis time for one sample is 6 s (scan cycle time is 20 ms and 1 segment consists of 20 scans and 1 analysis contains 15 segments).

Table 2. IMS operating conditions for explosive detection.

Parameter	Setting
Drift temperature	105 °C
Desorber temperature	224 °C
Inlet temperature	239 °C
Drift flow	55 mL/min
Sample flow	318 mL/min
Scan cycle time	20 ms
Analysis time	6 s

Results and Discussion

The plasmagrams of the standard solutions of TNT, RDX, PETN and TETRYL and the acetone extract are shown in Figure 4. The plasmagrams of the standard mixture solution and the handswab sample are shown in Figure 5. There are 2 peaks for TNT, 4 peaks for RDX, 3 peaks for PETN and 2 peaks for TETRYL in these plasmagrams. Reduced mobility K_0 , and drift times data for the 4 explosives are given in Table 3. TNT and RDX were detected from post-blast residue (Figure 4e). Hence it was determined that a bomb containing TNT and RDX had caused the explosion. On the other hand TNT and TETRYL were detected on the hand of the person who handled a M26 bomb (Figure 5b). M26 bombs are known to contain TNT as a main explosive charge and TETRYL as an initiator.

The standard solutions and their mixtures of TNT, RDX, PETN and TETRYL were also analysed using gas chromatography with a flame ionisation detector (GC/FID) and gas chromatography/mass spectrometry (GC/MS) which were developed in our laboratory using an appropriate temperature and flow rate program¹⁹. Since there were generally very small amounts of explosives present in post-blast residues, and especially in handswab samples, our objective was to determine the lowest concentrations of explosives in the samples by comparing 3 methods. The sensitivities of GC and GC/MS to TNT and TETRYL were greater than those to PETN and RDX. Therefore, it was not possible to examine these explosives at the same concentrations. The aromatic structure of TNT and TETRYL and the aliphatic structure of PETN and RDX may cause differences in sensitivities. Both GC/FID and GC/MS gave good peaks in terms of peak height and width at the concentrations tested as shown in Table 1.

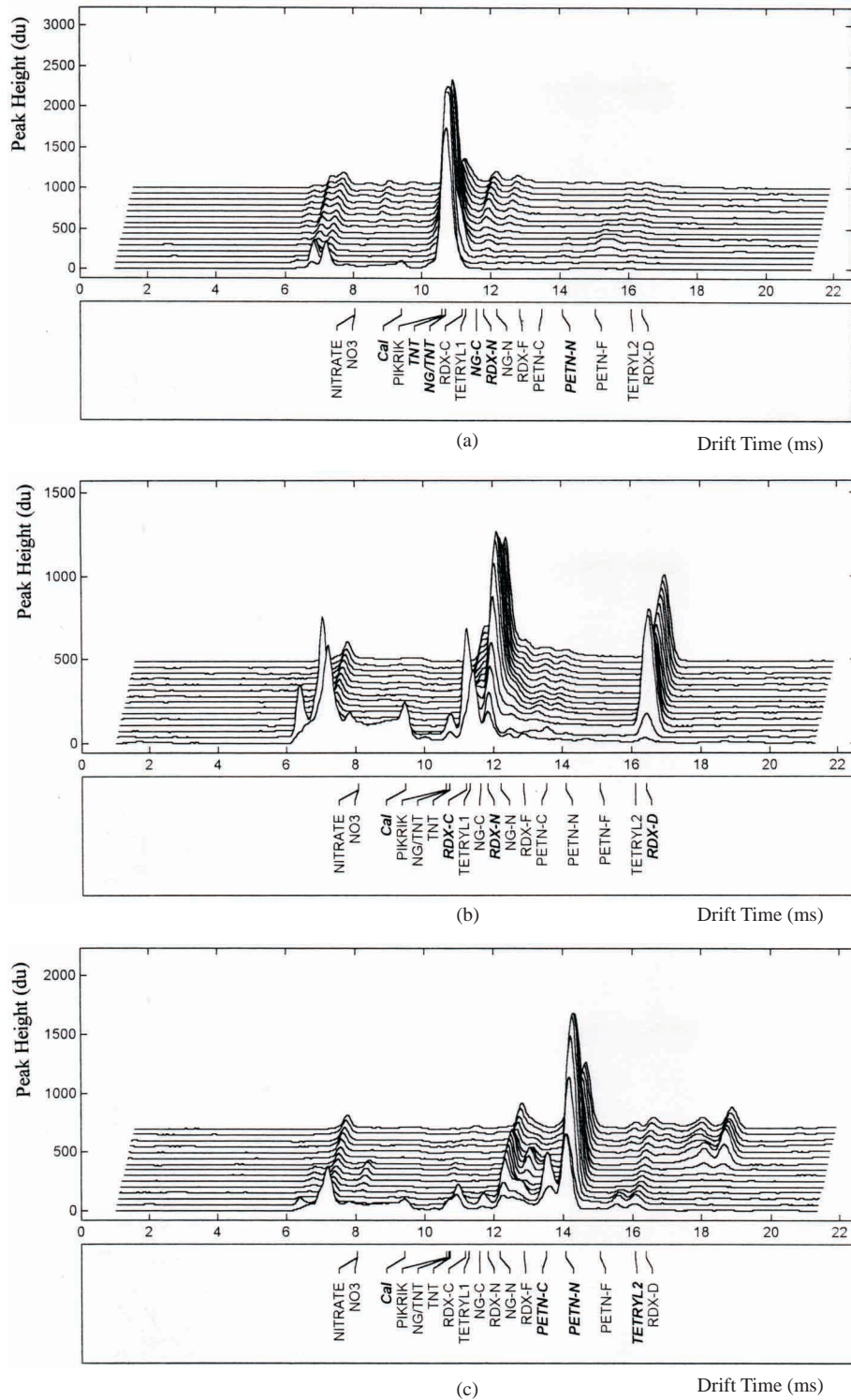
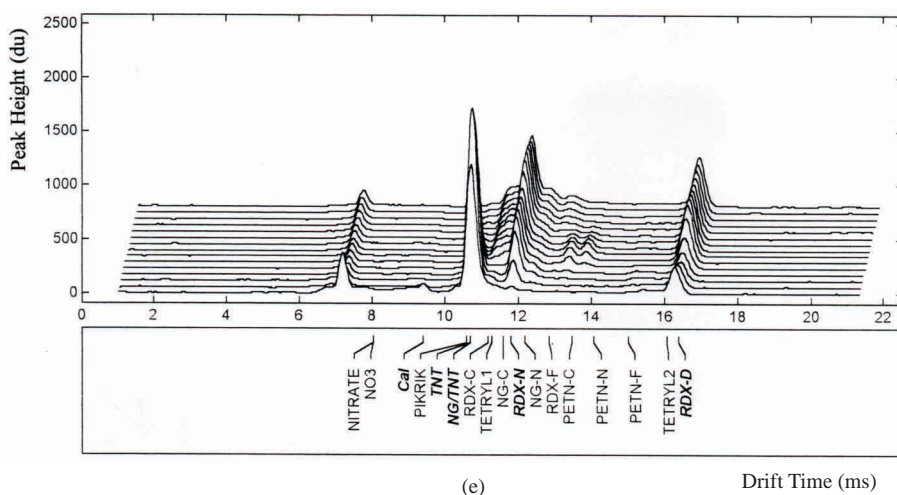
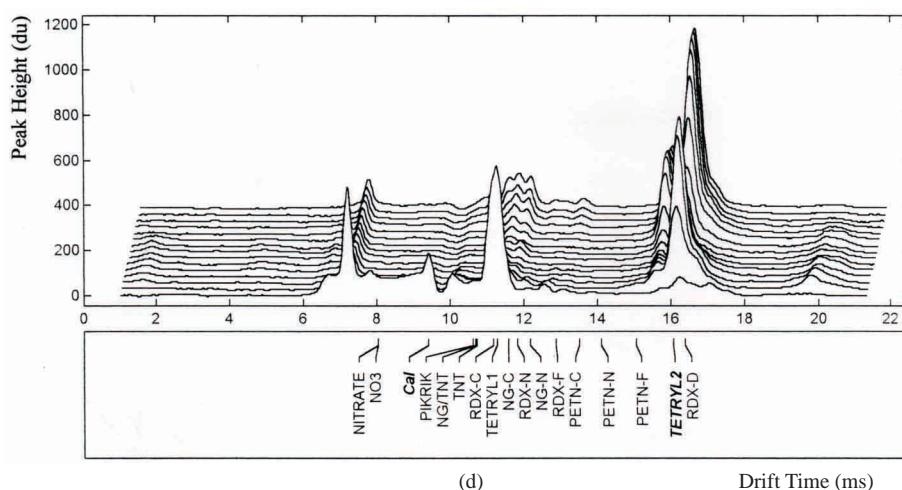

Figure 4. The plasmagrams of the TNT standard (a), RDX standard (b), PETN standard (c), TETRYL standard (d) and the acetone extract (e).

Figure 4. Continued.

IMS has also advantages compared with GC/FID and GC/MS in terms of sample volume necessary for testing. The sample volume injected for GC/FID and GC/MS was $1 \mu\text{L}$, while for IMS $0.1 \mu\text{L}$ was used. The retention times of PETN, TNT, RDX and TETRYL were 8.7, 14.0, 14.6 and 16.9 min for GC and 5.3, 10.9, 13.3 and 15.1 min for GC/MS, respectively. For IMS, the drift times of TNT, RDX, TETRYL and PETN were about 10.7, 13.1, 13.7 and 14.2 ms, respectively. Thus, for the analysis of these explosives faster response times and lower detection limits were obtained from IMS compared with GC and GC/MS. The type of explosive in the acetone extract of the explosion debris could be identified with GC or GC/MS. For the handswab identification was unsuccessful with GC or GC/MS, and it was possible only with IMS.

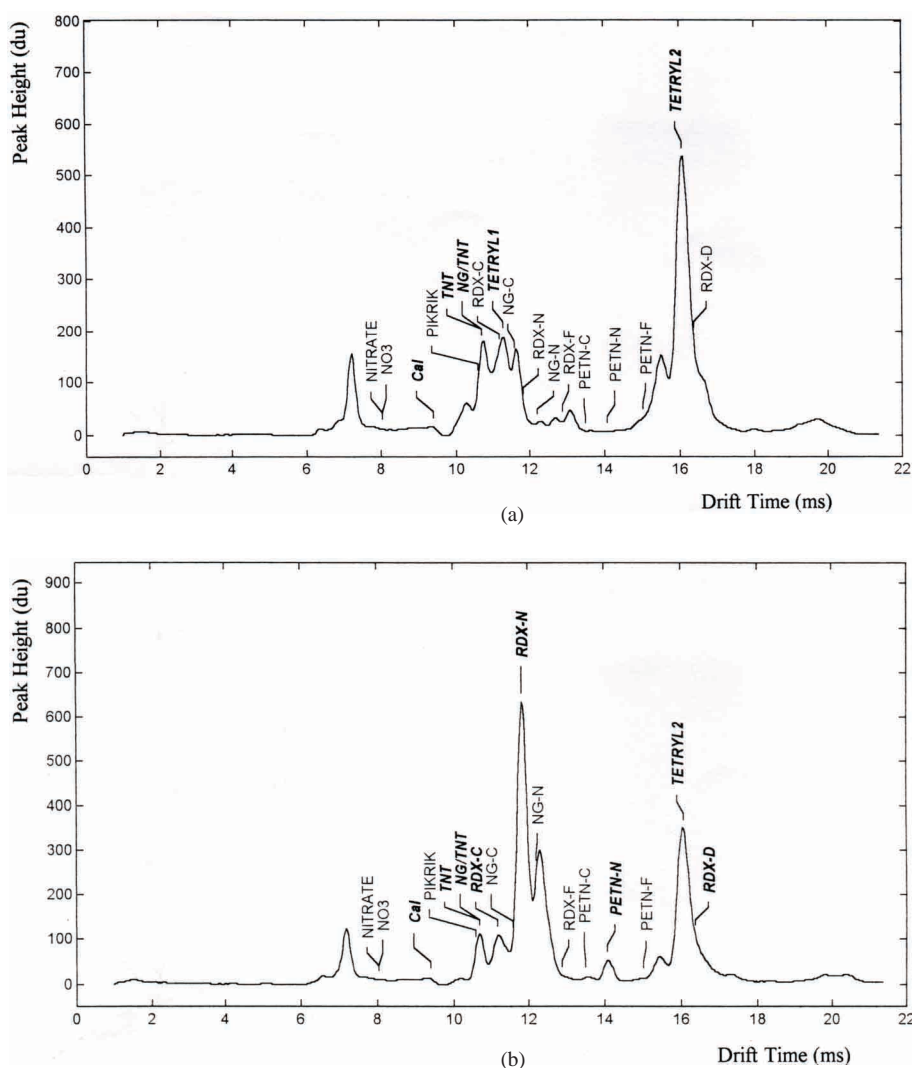

Figure 5. The plasmagrams of the standard mixture (a) and the handswab sample (b).

Table 3. Reduced mobility, K_0 and drift time data for the 4 explosives.

Explosive ions	Reduced mobility (K_0)	Drift time (ms)
NG/TNT	1.4535	10.679
TNT	1.4510	10.697
RDX-C	1.3895	11.171
RDX-N	1.3140	11.814
RDXF	1.2075	12.857
RDX-D	0.9486	16.370
PETN-C	1.1505	13.495
PETN-N	1.1030	14.076
PETN-F	1.0334	15.025
TETRYL1	1.3773	11.270
TETRYL2	0.9670	16.058

Conclusion

IMS has higher sensitivity than GC and GC/MS which allows the detection of explosives at nanogram levels. In addition by using IMS, response times as fast as 6 s are achieved. Easy sample collection in a cartridge located in a vacuum apparatus and direct analysis of the collected sample without any pre-treatment is another advantage of the IMS method. Being relatively small and portable, IMS is also easy to operate and does not require much technical skill.

Strong evidence of the presence of explosives on hands and transfer by contact to other surfaces may give law enforcement agents a new tool for the collection of physical evidence in trace amounts when dealing with suspected terrorists or bombers.

The chemical characteristics of a large number of compounds can be classified as explosives because of their strong electron affinities and high efficiency of creating negative ions through ion molecule reactions. Therefore, the potential sensitivity of an IMS system to these compounds is quite high. It is clear that IMS technology will integrate into many different fields in the future.

Nomenclature

A	Reactant ion
d	Drift region length (cm)
E	Electric field gradient
E_t	Drift time (s)
IMS	Ion mobility spectrometry
K	The mobility of the species
K_0	Reduced mobility
ms	Millisecond
P	Pressure (torr)
PETN	Pentaerythritoltetranitrate
RDX	1,3,5-trinitro-1,3,5-triazocyclohexane
s	Second
T	Temperature (K)
TETRYL	2,4,6-trinitrophenylmethylnitramine
TNT	2,4,6-trinitrotoluene
V_d	Drift velocity

References

1. T.W. Carr **Plasma Chromatography**, Plenum Press, New York, (1984).
2. M.J. Cohen and F.W. Karasek **J. Chromatogr. Sci.**, **49**, 330, (1970).
3. R.H. St. Louis and H.H. Hill **Critical Reviews in Anal. Chem.**, **5**, 321, (1990).
4. R.Wilson and A. Brittain **Royal Society of Chemistry**, **203**, 92-101, (1997).
5. Anonymous **Ionscan Model 400 Operator's Manual**, Barringer Instruments, Canada, (1996).
6. H. Koyuncu H. Ceylan M. Koyuncu and A. Çalıklı **XIV. Ulusal Kimya Kongresi**, 21, 10-15 Eylül, Diyarbakır, Türkiye, (2000).

7. D.D. Fetterolf and T.D. Clark **Journal of Forensic Sciences, JFSCA**, **38**, 28-39, (1993).
8. L.L. Danylewych-May and C. Cumming **4th International Symposium on Analysis and Detection of Explosives**, 385-401, September 7-10, Jerusalem, Israel, (1992).
9. H. Koyuncu H. Ceylan M. Koyuncu and A. Çalmlı **XIV. Ulusal Kimya Kongresi**, 355, 10-15 Eylül, Diyarbakır, Türkiye, (2000).
10. H.E. Revercomb and E.A. Mason **Anal Chem.**, **47**, 970, (1975).
11. G.A. Eiceman and Z. Karpas **Ion Mobility Spectrometry**, CRC Press, (1994).
12. Z. Karpas **Forensic Sci. Rev.**, **1**, 104-119, (1989).
13. B.J. Yelverton **Journal of Energetic Materials**, **6**, 73-80, (1988).
14. A.H. Lawrence and P. Neudorfl **Anal. Chem.**, **60**, 104-109, (1988).
15. J.P. Davies L.G. Blackwood S.G. Davis L.D. Goodrich and R.A. Larson **Anal. Chem.**, **65**, 3004-3009, (1993).
16. J. Yinon and S. Zitrin **Modern Methods and Applications in Analysis of Explosives**, John Wiley & Sons Ltd., England, (1993).
17. P. Kolla **J. Forensic Sci.**, **36**, 1342-1359, (1991).
18. A.W. Beveridge **Forensic Sci. Rev.**, **4**, 17-49, (1992).
19. H. Koyuncu **Examination of Some Organic Explosives by Gas Chromatography, Gas Chromatography-Mass Spectrometry and Ion Mobility Spectrometry**, Ph. D. thesis, Yüzüncü Yıl University, Van, (2001).