

1-1-2008

## Photo Organic Field Effect Transistor's Properties

KHASAN S. KARIMOV

IBRAHIM N. IBRAHIM

M. MAHROOF TAHIR

TAUSEEF AHMED KHAN

UMAR SHAFIQUE

Follow this and additional works at: <https://journals.tubitak.gov.tr/physics>



Part of the [Physics Commons](#)

---

### Recommended Citation

KARIMOV, KHASAN S.; IBRAHIM, IBRAHIM N.; TAHIR, M. MAHROOF; KHAN, TAUSEEF AHMED; and SHAFIQUE, UMAR (2008) "Photo Organic Field Effect Transistor's Properties," *Turkish Journal of Physics*: Vol. 32: No. 1, Article 3. Available at: <https://journals.tubitak.gov.tr/physics/vol32/iss1/3>

This Article is brought to you for free and open access by TÜBİTAK Academic Journals. It has been accepted for inclusion in Turkish Journal of Physics by an authorized editor of TÜBİTAK Academic Journals. For more information, please contact [academic.publications@tubitak.gov.tr](mailto:academic.publications@tubitak.gov.tr).

# Photo Organic Field Effect Transistor's Properties

Khasan S. KARIMOV<sup>1,2</sup>, Ibrahim QAZI<sup>2</sup>, M. Mahroof TAHIR<sup>3</sup>  
Tauseef Ahmed KHAN<sup>2</sup>, Umar SHAFIQUE<sup>2,4</sup>

<sup>1</sup>Physical Technical Institute of Academy of Sciences, Rudaki Ave.33, 734025, Dushanbe-TAJIKISTAN  
e-mail: khasan@giki.edu.pk

<sup>2</sup>GIK Institute of Engineering Science and Technology, Topi, Swabi, 23640 N.W.F.P, PAKISTAN

<sup>3</sup>St. Cloud State University, 720 Fourth Avenue, South St. Cloud, MN 56301-4498, USA

<sup>4</sup>International Islamic University Islamabad-PAKISTAN

Received 24.01.2007

## Abstract

A thin organic films of p-type semiconducting copper phthalocyanine (CuPc) film and semitransparent Al film were deposited in sequence by vacuum evaporation on glass substrate with Ag source and drain electrodes, fabricating an organic field effect transistor with metal (aluminum)-semiconductor (copper phthalocyanine) Schottky junction. The transistor was investigated for effect of illumination on its characteristics. It was found that the gate-source (Al-Ag) and gate-drain (also Al-Ag) dark current-voltage characteristics show rectification behavior. Under non-modulated filament-lamp illumination, photo-potential is developed between gate-source and gate-drain terminals. Drain current of this organic phototransistor (OPT) increased with illumination. An energy band diagram of the Al-CuPc junction and the equivalent circuit diagram of the OPT were produced.

**Key Words:** Organic Field Effect Transistor, Copper Phthalocyanine, Metal-Semiconductor Schottky Junction, Phototransistor.

## 1. Introduction

During the past decade, organic semiconductor field-effect transistors (OFET) based on organic materials as conjugated polymers, oligomers and low molecular weight materials have been investigated widely. Lower material and fabrication cost of OFET are attracting extensive interest for their potential applications in organic devices [1–5]. Some OFETs show sensitivity not only to the applied voltage itself but also to the electric field of the molecules as well. In [6] an OFET was described that was able to detect charged/uncharged chemical species in aqueous media via the field effect; chemical sensitivity of the organic transistor was illustrated for protons and glucose.

In recent years, organic phototransistors (OPT) have been fabricated and investigated as well. In [7], OPT based on a biphenyl end-capped fused bithiophene oligomer was described. Under 380 nm UV light the OPTs show a photocurrent response similar to the absorption spectrum of the organic semiconductor. It is expected that the OPTs may be used in highly sensitive UV sensors. Similar to a previous case in [7], in [8] the effect of ultraviolet light irradiation on the characteristics of organic phototransistor (OPT) containing sexithiophene (6-T) and pentacene was examined. The transistors showed both fast and slow responses. The slow response was observed over several weeks, suggesting the possibility of application in

light-addressable field-effect transistor memory devices. The most widely used organic semiconductors as pentacene, thiophene oligomers and regioregular polythiophene showed good performance in use in OFET, but further improvements may stall due to saturation [1].

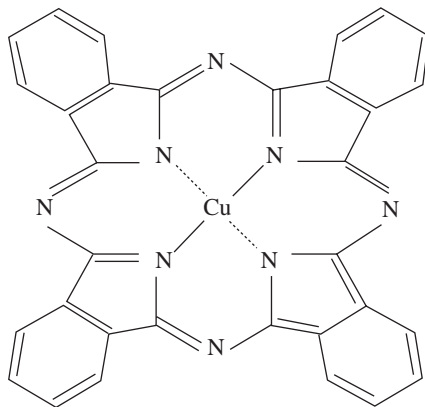
In [9], copper phthalocyanine (CuPc)/inorganic ferroelectric  $\text{PbZr}_{0.2}\text{Ti}_{0.8}\text{O}_3$  heterojunction gate and a ferromagnetic oxide semiconductor  $\text{La}_{0.87}\text{Ba}_{0.13}\text{MnO}_3$  channel photomemory was described: it was demonstrated the non-volatile and non-destructive photomemory operation. The device could write the light information via combination of light irradiation and negative gate bias, and delete only with the positive gate bias.

Organic semiconductors phthalocyanines [10] and especially CuPc is a well-studied organic photosensitive semiconductor. It has high absorption coefficient in wide spectrum and high photo-electromagnetic sensitivity at low intensities of radiation. Deposition of thin CuPc films by vacuum sublimation is simple. Purification of CuPc is simple and economical, as the sublimation occurs at not very high temperatures (400–600 °C). In [11, 12] we fabricated and investigated the properties and characteristics of organic-on-inorganic Ag/p-CuPc/n-GaAs/Ag photoelectric sensors at room and elevated temperatures in photovoltaic mode and photoconduction mode of operation under tungsten filament lamp illumination. Photocurrent and photo-voltage spectra showed that cell is sensitive in the large spectral range 200–1000 nm, from UV to visible and NIR spectrum.

In [13] it was described the numerical simulation and properties of the Schottky junction transistor on the base of Si. The results for a device with a 0.5  $\mu\text{m}$  gate length suggest that cutoff frequencies approaching 10 GHz can be achieved. In this paper the properties of OPT with CuPc and Schottky junction (Al-CuPc) are reported that have the structure of MESFET, unlike MOSFETs described in [7, 8].

## 2. Experimental

The CuPc was obtained from Sigma-Aldrich. Figure 1 shows the molecular structure of the CuPc molecule used as a p-type organic semiconductor [14, 15]. At least seven crystalline polymorph states of CuPc are known to exist:  $\alpha$ ,  $\beta$ ,  $\gamma$ , R,  $\delta$ ,  $\epsilon$ , etc. [16]. The  $\alpha$ -CuPc form is metastable at  $T = 165$  °C and can be converted thermally or with solution to  $\beta$ -form. The  $\alpha$  and  $\beta$  forms are the most frequently encountered states of CuPc.

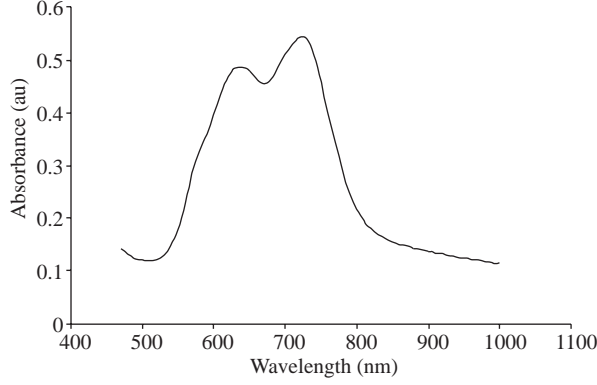


**Figure 1.** Molecular structure of CuPc.

X-ray diffraction data showed that the deposited CuPc films were in  $\alpha$ -form [17]. Scanning electron micrographs showed that no particular crystal orientations in the CuPc films [16]. A band gap of CuPc was equal to 1.6 eV and a conductivity was equal to  $5 \times 10^{-13} \text{ } \Omega^{-1} \cdot \text{cm}$  at  $T = 300$  K [14, 15]. Sublimation temperatures varied from 400 °C at pressure  $p = 10^{-4}$  Pa to 580 °C at  $p = 10^{-4}$  Pa [10].

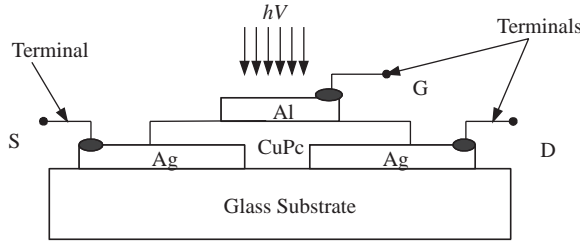
Thin films of CuPc were thermally sublimed onto glass substrate (with preliminary deposited silver electrodes) at 400–450 °C and  $\sim 10^{-4}$  Pa in an Edwards AUTO 306 vacuum coater with a diffusion pump

vacuum system. The substrate's temperature in this process was held at  $\sim 40$  °C. The CuPc film was deposited on glass substrates at the same conditions. Perkin Elmer Lambda 19 UV/VIS/NIR spectrometer was used for measurements of absorption spectra (Figure 2). The spectra covers the NIR-UV, i.e. the wavelengths 200–1000 nm.



**Figure 2.** Absorption spectra of p-CuPc film deposited on glass substrate by vacuum evaporation.

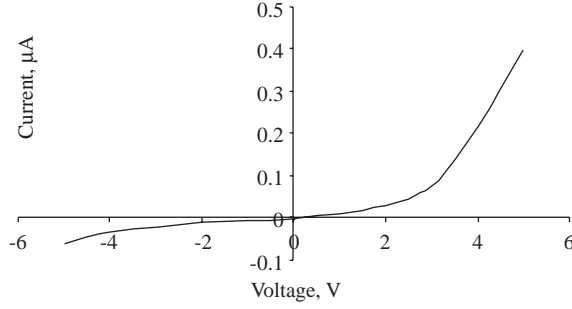
On CuPc film a semi-transparent Al film (transparency was equal to 15%) was also deposited. Thickness of the CuPc was determined via a Edwards FTM5 film thickness monitor. Earlier investigations showed that CuPc forms ohmic contacts with Ag and Schottky type rectifying contacts with Al [10]. Figure 3 shows cross-sectional view of the fabricated OFET: source and drain terminal connected with Ag films and gate terminal with Al film. Length, width and thickness of the CuPc channel were equal to 0.1 mm, 10 mm and 20 nm respectively. A filament incandescent lamp was used as a source of light. Voltage and current were measured with digital meters at room temperature.



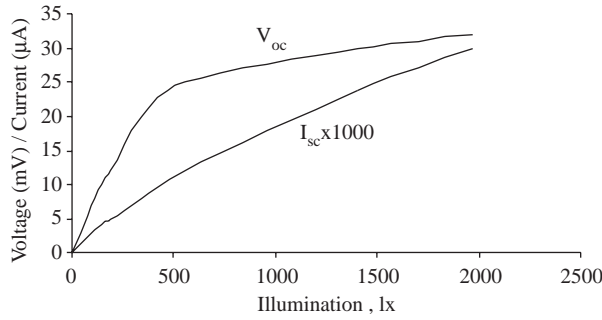
**Figure 3.** Cross sectional view of the organic photo-transistor.

### 3. Results and Discussion

Figure 4 shows  $I - V$  characteristics of gate-source junction of the OPT measured under dark condition and zero source-drain voltage. It is seen that the characteristics shows rectification behavior. The same  $I - V$  characteristics was observed between gate-drain terminals of the OPT. Rectification ratio  $RR$  defined as a ratio of forward and reverse currents at the same voltages (here,  $V = \pm 4$  V) was equal to 7. In forward bias the “+” voltage of power supply was applied to the source/drain with respect of the gate. Figure 5 shows open-circuit voltage/short-circuit current and illumination relationships obtained for the gate-source/drain terminals of the OPT. It is seen that photo-induced voltage and current are proportional to illumination. The gate-source and gate-drain junctions play the role of photoelectric cells. The results shown in Figure 4 and Figure 5 confirm that in the OPT the junction between gate and source-drain channel is really a rectifying contact, i.e. it is Schottky type junction.

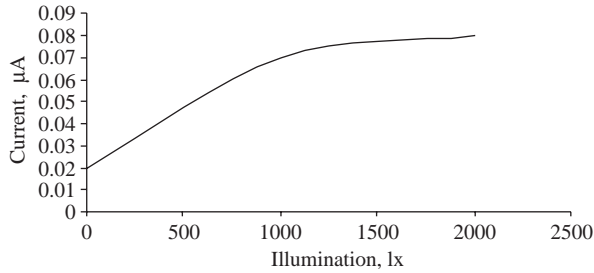


**Figure 4.** Dark I-V curve of the gate-source/drain (Al / p-CuPc) metal-semiconductor junction of the OPT.



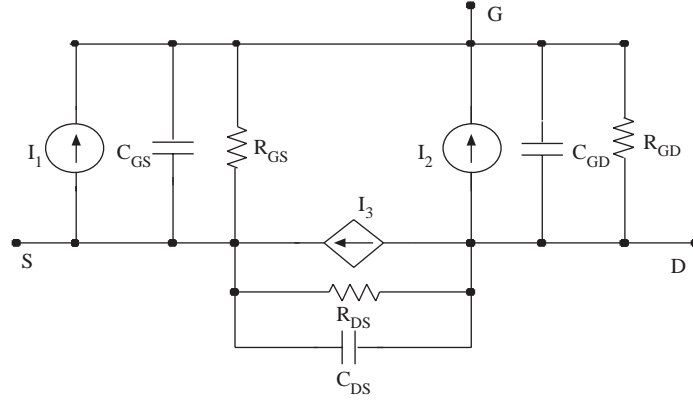
**Figure 5.** Open-circuit voltage/short-circuit current-illumination relationships obtained for the gate-source/drain terminals of the OPT.

Figure 6 shows drain current-illumination relationship at drain-source voltage  $V_{ds} = 5$  V. It is seen that the drain current increases with illumination (in the range of 0–1000 lx) in 3.5 time (ratio of light ON/OFF currents), that is comparable with the response of the OPT described in [8].



**Figure 6.** Drain current-illumination relationship at drain-source voltage  $V_{ds} = 5$  V.

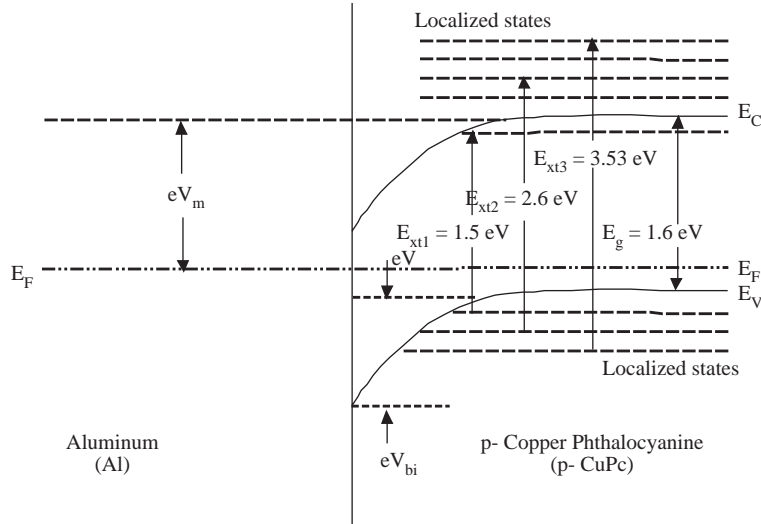
Figure 7 shows a simplified equivalent circuit of the OPT. In the equivalent circuit design it was used the circuits of FETs [18], OFET [19] and organic-inorganic photoelectric cell [12]. It was assumed that: (i) effect of the light to independent current sources ( $I_1$  and  $I_2$ ) and dependent current source  $I_3$  was linear; (ii) the drain and source series resistances were neglected; and (iii) drain-source voltage ( $V_{ds}$ ) was constant and gate-source voltage  $V_{gs} = 0$ . In the circuit the independent current sources  $I_1$  and  $I_2$  represent the Al-CuPc junction photoelectric cells, whereas the dependent current source  $I_3$  represent the source-drain channel as a variable resistance,  $R_{gs}$  and  $C_{gs}$  are the gate-to-source diffusion resistance and junction capacitance, respectively. The parameters  $R_{gd}$  and  $C_{gd}$  are the gate-to-drain resistance and capacitance, respectively. The resistance  $R_{ds}$  is the drain resistance, the  $C_{ds}$  capacitance is mainly a drain-to-source parasitic capacitance.



**Figure 7.** A simplified equivalent circuit of the OPT.

Taking into account the data shown in Figure 2 (Absorption maximum of the CuPc spectrum corresponds to the energy of 1.5 eV) and Figure 4, including the concepts related to heterojunction properties [18, 20], an energy-band diagram of the Al/p-CuPc metal-semiconductor junction (Figure 8) was developed.

Figure 8 shows the energy-band diagram of the Al/p-CuPc metal-semiconductor junction. The salient features of the diagram are: the Schottky barrier  $eV_m$ , i.e. potential barrier as seen by the electrons in the metal trying to move into the semiconductor;  $eV_{bi}$ , the built-in potential barrier seen by holes [18]; and  $E_c$ ,  $E_v$  and  $E_g$ , which are the bottom of the conduction band, top of the valence band and gap, respectively. Mobility of the majority charge carriers of CuPc [10] are equal to  $10^{-3}$  cm<sup>2</sup>/Vsec. Therefore in the CuPc side of the junction, unlike the delocalized states in the Al side, there are localized states because in CuPc mobility of charge carriers is much less than 1 cm<sup>2</sup>/V sec [1].



**Figure 8.** Energy-band diagram of the Al/p-CuPc metal-semiconductor junction.

The two mechanisms, namely, photoconductive behavior and photovoltaic behavior seem responsible for the photoresponse of the OPT, as is discussed in [7, 8]. Photoconductive behavior (the increase of conductance in the effect of light) occurs due to generation of excitons by absorbed photons, which are of higher energy than the band gap of the organic semiconductor CuPc and splitting of the excitons into electrons and holes by a source-drain field. Photovoltaic behavior (generation of voltage due to effect of light) is observed due to the presence of the rectifying metal-semiconductor junction with built-in potential barrier and electric field that in turn split the excitons into electron-hole pairs. Under illumination, the

metal-semiconductor potential barrier, and the electric field as well, decrease causing increase of the OPT channel cross-section, and thus an increase of channel conductivity.

As is known [8], the responsivity is given by the relation

$$R = \frac{I_{ph}}{P} = \frac{(I_{di} - I_{dd})}{EA}, \quad (1)$$

where  $I_{ph}$  is the generated drain current by light irradiation,  $P_{inc}$  is the optical power incident on the channel of the device,  $I_{di}$  is the drain current under illumination,  $I_{dd}$  is the drain current in the dark condition,  $E$  is the irradiation of the incident light and  $A$  is the effective device area (area of the channel); and the ratio of photo-on and dark-off currents

$$r = \frac{I_{di}}{I_{dd}} \quad (2)$$

indicate the performance of the photodetector. In this case, it was found that  $R = 0.03 \text{ A/W}$  and  $r = 3.5$ , respectively, under illumination of 1000 lx (a radiation intensity of  $1.5 \text{ mW/cm}^2$ ). The parameters obtained for the investigated OPT are lower with comparison with OPT described in [7, 8]. In the former case the transistor is simple and cheaper (metal-organic semiconductor Schottky junction was fabricated), than in the later case, where organic semiconductor was deposited on  $\text{SiO}_2/\text{Si}$  substrate.

In [7, 8] the expressions for the photocurrent caused by the photovoltaic effect and photocurrent induced by a photoconductive effect are presented. At the same time the properties of the OPT may be simulated by use of equivalent circuit (Figure 7) as well (a matter of future work).

## 4. Conclusion

CuPc based OPT with Schottky junction (Al-CuPc) was fabricated and investigated, and the electrical characteristics under incandescent illumination was examined. Examination of the dark current-voltage characteristics and voltage/current/illumination relationships confirm rectifying behavior of the gate-source and gate-drain junctions, and the character of the photoelectric properties. The photoconductive and photovoltaic effects are thought responsible for the increase in drain current due to illumination. We developed an equivalent circuit of the OPT where gate-source and gate-drain junctions are represented as independent of current sources, and the source-drain channel is current source dependent. By use of the CuPc absorption spectra and data obtained in the investigation of electric properties of the OPT, the energy band diagram of the Al-CuPc junction was designed. Further improvement of the OPT's performance may be made by optimization of the thickness of Al and CuPc films, and channel gap width and length as well.

## Acknowledgment

The authors are thankful to National Engineering and Scientific commission of Pakistan for support of this work.

## References

- [1] C. D. Dimitrakopoulos, D. J. Mascaró, *IBM J. Res. & Dev.*, **45**, (2001), 11.
- [2] H. L. Gomes, P. Stallinga, *Applied Physics Letter*, **84**, (2004), 1.
- [3] P. Stallinga, H.L.Gomes, *Journal of Applied Physics*, **96**, (2004), 5277.
- [4] H. L. Gomes, P. Stallinga, F. Dinelli, M. Murgia, F. Biscarini, D. M. de Leeuw, M. Muccini, K. Mullen, *Polym. Adv. Technol.*, **16**, (2005), 227.

- [5] S. F. Nelson, *Applied Physics Letters*, **72**, (1998), 1854.
- [6] C. Bartic, A. Campitelli, S. Borghs, *Applied Physics Letters*, **82**, (2003), 475.
- [7] Y-Y. Noh, D-Y. Kim, Y. Yoshida, K. Yase, B-J Jung, E. Lim, H-K Shim, *Applied Physics Letters*, **86**, (2006), 1.
- [8] Y-Y. Noh, J. Ghim, S-J. Kang, K-J. Baeg, D-Y. Kim, K. Yase, *Journal of Applied Physics*, **100**, (2006), 1.
- [9] Y-G. Park, T. Kanki, H-Y. Lee, H. Tanaka, T. Kawai, *Solid-State Electronics*, **47**, (2003), 2221.
- [10] M. I. Fedorov, Ph.D. Thesis, Institute of Chemical Physics, Chernogolovka, Moscow, Russia, 1973.
- [11] Kh. S. Karimov, Kh. M. Akhmedov, A. A. Dzhuraev, M. N. Khan, S. M. Abrarov, M. I. Fiodorov, *Eurasian Chem. Tech. Journal*, **3-4**, (2000), 251.
- [12] Kh. S. Karimov, M. M. Ahmed, S. A. Moiz, M. I. Fedorov, *Solar Energy Materials & Solar Cells*, **87**, (2005), 61.
- [13] T. Thornton, *IEEE Transactions on Electron Devices*, **48**, (2001), 2421.
- [14] F. Gutman, L. E. Lyons, *Organic semiconductor*, Part A, (Robert E. Krieger Publishing Company, Malabar, Florida 1980), p. 251.
- [15] F. Gutman, H. Keyzer, L. E. Lyons, R. B. Somoano, *Organic semiconductors*, Part B, (Robert E. Krieger Publishing Company, Malabar, Florida 1983), p. 122.
- [16] M. K. Debe, R. I. Poirer, D. D. Erickson, T. N. Tommet, D. R. Field, K. M. White, *Thin Solid Films*, 186, (1990), 257.
- [17] Kh.Karimov, S. Bellingeri, Y. Abe, In book: *Processing by Centrifugation*, Edited by L. L. Regel and W. R. Wilcox, (Kluwer Academic/Plenum Publishers, New York, 2001), p. 99.
- [18] D. A. Neamen, *Semiconductor Physics and Devices*, (Richard D. Irwin, Inc, USA, 1992), p. 467.
- [19] M. Jaiswal, R. Menon, *Applied Physics Letters*, **88**, (2006), 1.
- [20] M. M. Ahmed, Kh. S. Karimov, S. A. Moiz, *IEEE Transactions on electron devices*, **51**, (2004), 121.