

1-1-2019

## On the distance formulae in the generalized taxicab geometry

HARUN BARIŞ ÇOLAKOĞLU

Follow this and additional works at: <https://dctubitak.researchcommons.org/math>



Part of the [Mathematics Commons](#)

---

### Recommended Citation

ÇOLAKOĞLU, HARUN BARIŞ (2019) "On the distance formulae in the generalized taxicab geometry," *Turkish Journal of Mathematics*: Vol. 43: No. 3, Article 35. <https://doi.org/10.3906/mat-1809-78>  
Available at: <https://dctubitak.researchcommons.org/math/vol43/iss3/35>

This Article is brought to you for free and open access by TÜBİTAK Academic Journals. It has been accepted for inclusion in Turkish Journal of Mathematics by an authorized editor of TÜBİTAK Academic Journals.

## On the distance formulae in the generalized taxicab geometry

Harun Barış ÇOLAKOĞLU\*

Vocational School of Technical Sciences, Akdeniz University, Antalya, Turkey

Received: 07.12.2018

Accepted/Published Online: 25.04.2019

Final Version: 29.05.2019

**Abstract:** In this paper, we first determine the generalized taxicab distance formulae between a point and a line and two parallel lines in the real plane, then we determine the generalized taxicab distance formulae between a point and a plane, two parallel planes, a point and a line, two parallel lines and two skew lines in three dimensional space, giving also the relations between these formulae and their well-known Euclidean analogs. Finally, we give the generalized taxicab distance formulae between a point and a plane, a point and a line and two skew lines in  $n$ -dimensional space, by generalizing the concepts used for three dimensional space to  $n$ -dimensional space.

**Key words:** Generalized taxicab distance, metric, generalized taxicab geometry, three dimensional space,  $n$ -dimensional space

### 1. Introduction

Taxicab geometry was introduced by Menger [10] and developed by Krause [9], using the taxicab metric which is the special case of the well-known  $l_p$ -metric (also known as the Minkowski distance) for  $p = 1$ . In [11], Wallen altered the taxicab metric by redefining it in order to get rid of imperative symmetry, and called it (*slightly*) *generalized taxicab metric* (also known as the *weighted taxicab metric*; see [6]). Later, isometries, trigonometry, and some properties in the generalized taxicab plane are investigated in [2, 3, 5, 7, 8]. Then, Euclidean isometries were given in three dimensional generalized taxicab space in [4].

In the generalized taxicab geometry; points, lines, and planes are the same as the Euclidean ones, but the distance function is different. Thus, the generalized taxicab analogs of topics that include the distance concept may also be different and interesting. In the plane, for points  $P_1 = (x_1, y_1)$ ,  $P_2 = (x_2, y_2)$ , and positive real numbers  $\lambda_1$  and  $\lambda_2$ , the generalized taxicab metric is defined by

$$d_{T_g}(P_1, P_2) = \lambda_1 |x_1 - x_2| + \lambda_2 |y_1 - y_2| \quad (1.1)$$

while the well-known Euclidean metric is

$$d_E(P_1, P_2) = [(x_1 - x_2)^2 + (y_1 - y_2)^2]^{1/2}. \quad (1.2)$$

Geometrically, the generalized taxicab distance between  $P_1$  and  $P_2$  is the sum of weighted lengths of line segments joining the points, each of which is parallel to a coordinate axis, while the Euclidean distance between  $P_1$  and  $P_2$  is the length of the straight line segment joining the points (see Figures 1 and 2).

\*Correspondence: hbcolakoglu@akdeniz.edu.tr

2010 AMS Mathematics Subject Classification: 51K05, 51K99, 51N20.

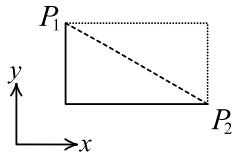

Figure 1.

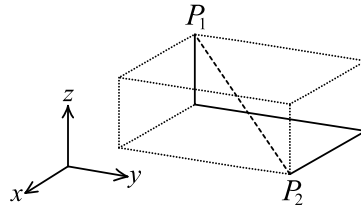

Figure 2.

In recent years, beyond the mathematics, metrics with their properties, especially the well-known  $l_p$ -metric with its special cases; taxicab (also known as  $l_1$  or Manhattan), Euclidean (also known as  $l_2$ ), and maximum (also known as  $l_\infty$  or Chebyshev) metrics, have been very important keys for many application areas such as data mining, machine learning, pattern recognition, and spatial analysis. In this study, mainly we determine some distance properties of the weighted taxicab metric in two, three, and  $n$ -dimensional spaces, considering that these weights can reflect relative importance of different criteria or dimensions. Here, we first investigate formulae for the generalized taxicab distance between a point and a line and two parallel lines in the real plane, and then formulae for the generalized taxicab distance between a point and a plane, two parallel planes, a point and a line, two parallel lines and two skew lines in three dimensional space, determining the relations between the given formulae and their Euclidean analogs which are well-known already. Lastly, we determine the generalized taxicab distance formulae between a point and a plane, a point and a line and two skew lines for  $n$ -dimensional space, by generalizing the concepts that we used in three dimensional space to  $n$ -dimensional space.

**2. Generalized taxicab distance formulae in  $\mathbb{R}^2$  and  $\mathbb{R}^3$**

One can see that in the plane the unit generalized taxicab circle is a rhombus with vertices  $V_1 = (1/\lambda_1, 0)$ ,  $V'_1 = (-1/\lambda_1, 0)$ ,  $V_2 = (0, 1/\lambda_2)$ ,  $V'_2 = (0, -1/\lambda_2)$ , having points  $(x, y)$  on it, satisfying the equation  $\lambda_1 |x| + \lambda_2 |y| = 1$  (see Figure 3).

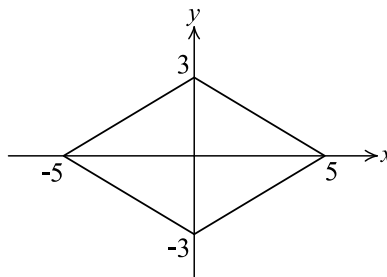
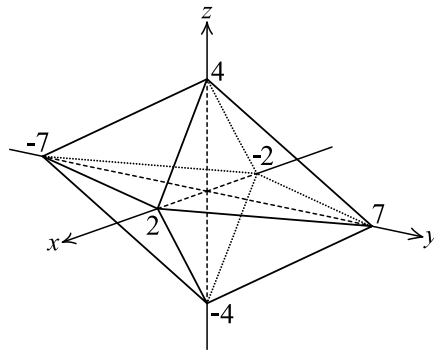

Figure 3. The unit generalized taxicab circle for  $\lambda_1 = 1/5$ ,  $\lambda_2 = 1/3$ .

Besides, in three dimensional space, for points  $P_1 = (x_1, y_1, z_1)$ ,  $P_2 = (x_2, y_2, z_2)$ , and positive real numbers  $\lambda_1$ ,  $\lambda_2$ , and  $\lambda_3$ , the generalized taxicab metric is defined by

$$d_{T_g}(P_1, P_2) = \lambda_1 |x_1 - x_2| + \lambda_2 |y_1 - y_2| + \lambda_3 |z_1 - z_2|, \tag{2.1}$$

and one can also see that the unit generalized taxicab sphere is an octahedron with vertices  $V_1 = (1/\lambda_1, 0, 0)$ ,  $V'_1 = (-1/\lambda_1, 0, 0)$ ,  $V_2 = (0, 1/\lambda_2, 0)$ ,  $V'_2 = (0, -1/\lambda_2, 0)$ ,  $V_3 = (0, 0, 1/\lambda_3)$ ,  $V'_3 = (0, 0, -1/\lambda_3)$ , having points  $(x, y, z)$  on it, satisfying the equation  $\lambda_1 |x| + \lambda_2 |y| + \lambda_3 |z| = 1$  (see Figure 4).



**Figure 4.** The unit generalized taxicab sphere for  $\lambda_1 = 1/2$ ,  $\lambda_2 = 1/7$ ,  $\lambda_3 = 1/4$ .

We use generalized taxicab circle generalized taxicab, sphere, and tangent notions as our main tools in this study. Let us clarify the *tangent* notion by the following definition given as a natural analog to the Euclidean geometry:

**Definition 2.1** *Given a generalized taxicab circle with center  $P$  and radius  $r$ , in the plane. We say that a line is tangent to the generalized taxicab circle, if its generalized taxicab distance from  $P$  is  $r$ . Similarly, given a generalized taxicab sphere with center  $P$  and radius  $r$ , in the three dimensional space. We say that a plane or a line is tangent to the generalized taxicab sphere, if its generalized taxicab distance from  $P$  is  $r$ .*

In Figure 5, see that the generalized taxicab distance from the point  $P$  to the lines  $\ell_1$  and  $\ell_2$  is equal to the radius of the given generalized taxicab circle with center  $P$ . Thus, the lines  $\ell_1$  and  $\ell_2$  are tangent to the generalized taxicab circle, at a vertex and an edge respectively. Obviously, there are infinitely many tangent lines at a vertex, while there is only one tangent line at an edge of the generalized taxicab circle.

In Figure 6, see that the generalized taxicab distance from the point  $P$  to the planes  $\Pi_1$ ,  $\Pi_2$ ,  $\Pi_3$ , and lines  $\ell_1$  and  $\ell_2$  is equal to the radius of the given generalized taxicab sphere with center  $P$ . Thus, the planes  $\Pi_1$ ,  $\Pi_2$  and  $\Pi_3$  are tangent to the generalized taxicab sphere, at a vertex, an edge, and a face respectively; and the lines  $\ell_1$  and  $\ell_2$  are tangent to the generalized taxicab sphere, at a vertex and a line segment, respectively. Clearly, there are infinitely many tangent planes at a point on an edge (that can also be a vertex) or an edge, while there is only one tangent plane at a face of the generalized taxicab sphere, and there are infinitely many tangent lines at a point on an edge (that can also be a vertex), while there is only one tangent line at a line segment on a face (that can also be an edge) of the generalized taxicab sphere.

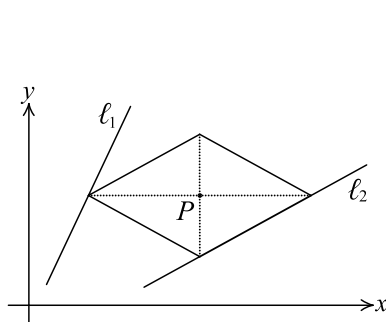

**Figure 5.**

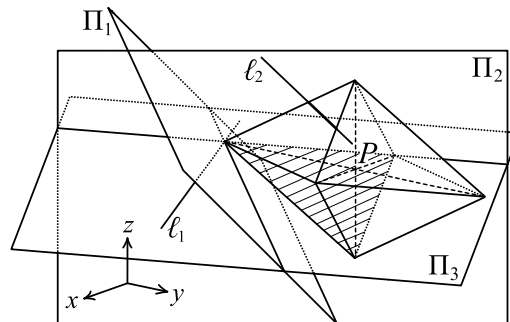

**Figure 6.**

Clearly, in the plane, the generalized taxicab distance from a point to a line, is equal to the radius of the expanding generalized taxicab circle when the line touches to the generalized taxicab circle -in other words, the line becomes tangent to the generalized taxicab circle. The following proposition gives the formula for the generalized taxicab distance between a point and a line, with an equation which relates the Euclidean distance to the generalized taxicab distance between a point and a line in the plane.

**Proposition 2.2** *The generalized taxicab distance between a point  $P = (x_0, y_0)$  and a line  $\ell : Ax + By + C = 0$  in  $\mathbb{R}^2$  is*

$$d_{T_g}(P, \ell) = \frac{|Ax_0 + By_0 + C|}{\max\{|A/\lambda_1|, |B/\lambda_2|\}}. \tag{2.2}$$

In addition,

$$\frac{d_E(P, \ell)}{d_{T_g}(P, \ell)} = \frac{\max\{|A/\lambda_1|, |B/\lambda_2|\}}{(A^2 + B^2)^{1/2}}. \tag{2.3}$$

**Proof** Clearly, the generalized taxicab distance between the point  $P$  and the line  $\ell$  is

$$d_{T_g}(P, \ell) = \min\{d_{T_g}(P, X) : X \in \ell\},$$

which is equal to the radius of the generalized taxicab circle with center  $P$ , such that the line  $\ell$  is tangent to it. Then, at least one vertex of the generalized taxicab circle is on  $\ell$ , which is also on one of the lines through  $P$  and parallel to a coordinate axis. In other words, if  $\ell_x$  and  $\ell_y$  denote the lines passing through  $P$  and parallel to  $x$  and  $y$  axis respectively, then there exists at least one of the points

$$Q_1 = \ell \cap \ell_x \text{ and } Q_2 = \ell \cap \ell_y,$$

which can be expressed by  $Q_1 = (x_{Q_1}, y_0)$ ,  $Q_2 = (x_0, y_{Q_2})$ , such that  $\ell$  is tangent to the generalized taxicab circle at least one of them (see Figure 7).

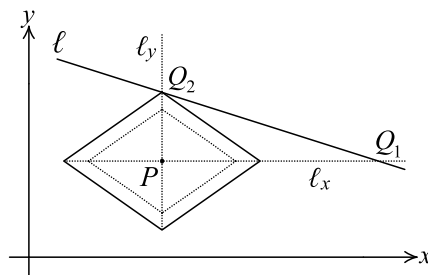

Figure 7.

Thus, we have

$$d_{T_g}(P, \ell) = \min\{d_{T_g}(P, Q_1), d_{T_g}(P, Q_2)\}.$$

For the case  $A \neq 0$  and  $B \neq 0$ ,  $Q_1$  and  $Q_2$  exist and we obtain

$$d_{T_g}(P, Q_1) = \lambda_1 |x_0 - x_{Q_1}| = \lambda_1 \left| x_0 - \frac{-By_0 - C}{A} \right| = \frac{|Ax_0 + By_0 + C|}{|A/\lambda_1|}$$

and

$$d_{T_g}(P, Q_2) = \lambda_2 |y_0 - y_{Q_2}| = \lambda_2 \left| y_0 - \frac{-Ax_0 - C}{B} \right| = \frac{|Ax_0 + By_0 + C|}{|B/\lambda_2|}.$$

Then we have

$$d_{T_g}(P, \ell) = \min \left\{ \frac{|Ax_0 + By_0 + C|}{|A/\lambda_1|}, \frac{|Ax_0 + By_0 + C|}{|B/\lambda_2|} \right\},$$

and so

$$d_{T_g}(P, \ell) = \frac{|Ax_0 + By_0 + C|}{\max \{|A/\lambda_1|, |B/\lambda_2|\}}.$$

Other cases affect only existence of points  $Q_1$  and  $Q_2$ , and do not change the conclusion. Besides, since we have

$$d_E(P, \ell) = \frac{|Ax_0 + By_0 + C|}{(A^2 + B^2)^{1/2}},$$

we get equation (2.3). □

**Remark 2.3** *If we label the foot of the perpendicular from the point  $P$  to the line  $\ell$  by  $H$ , then we get*

$$d_E(P, \ell) = d_E(P, H) = \frac{|Ax_0 + By_0 + C|}{(A^2 + B^2)^{1/2}}.$$

*On the other hand, one can easily see that*

$$\frac{d_E(P, H)}{d_{T_g}(P, H)} = \frac{(A^2 + B^2)^{1/2}}{\lambda_1 |A| + \lambda_2 |B|}.$$

*Thus, we obtain*

$$d_{T_g}(P, H) = \frac{(\lambda_1 |A| + \lambda_2 |B|) |Ax_0 + By_0 + C|}{A^2 + B^2}.$$

*Concerning equations (2.2) and (2.3), in general, we have*

$$d_{T_g}(P, \ell) \neq d_{T_g}(P, H) \quad \text{and} \quad \frac{d_E(P, H)}{d_{T_g}(P, H)} \neq \frac{d_E(P, \ell)}{d_{T_g}(P, \ell)}.$$

*Another fact is that nearest point or points on the line  $\ell$  to the point  $P$ , in the generalized taxicab sense, are the points of tangency of the line  $\ell$  to the generalized taxicab circle with center  $P$  and radius  $d_{T_g}(P, \ell)$ , so either there is only one nearest point or there are infinitely many nearest points on a line to a point (see Figure 5).*

The following example is an application of equation (2.2):

**Example 2.4** *Let us find the generalized taxicab distance between the point  $P = (1, 2)$  and the line  $\ell : x+2y-7 = 0$  in  $\mathbb{R}^2$ . Using equation (2.2), one gets*

$$d_{T_g}(P, \ell) = \frac{2}{\max\{1/\lambda_1, 2/\lambda_2\}} = \min\{2\lambda_1, \lambda_2\}.$$

In fact,  $\ell_x : y = 2$ ,  $\ell_y : x = 1$ , and  $Q_1 = (3, 2)$ ,  $Q_2 = (1, 3)$ . Thus, we get  $d_{T_g}(P, Q_1) = 2\lambda_1$ ,  $d_{T_g}(P, Q_2) = \lambda_2$ , and then

$$d_{T_g}(P, \ell) = \min\{2\lambda_1, \lambda_2\}.$$

Clearly, two distinct lines either intersect or are parallel, and the generalized taxicab distance between two intersecting lines is 0. The following corollary which follows directly from Proposition 2.2, gives the formula for the generalized taxicab distance between two parallel lines, with an equation which relates the Euclidean distance to the generalized taxicab distance between two parallel lines in the plane:

**Corollary 2.5** *The generalized taxicab distance between two parallel lines  $\ell_1 : Ax + By + C_1 = 0$  and  $\ell_2 : Ax + By + C_2 = 0$  in  $\mathbb{R}^2$  is*

$$d_{T_g}(\ell_1, \ell_2) = \frac{|C_1 - C_2|}{\max\{|A/\lambda_1|, |B/\lambda_2|\}}. \tag{2.4}$$

In addition,

$$\frac{d_E(\ell_1, \ell_2)}{d_{T_g}(\ell_1, \ell_2)} = \frac{\max\{|A/\lambda_1|, |B/\lambda_2|\}}{(A^2 + B^2)^{1/2}}. \tag{2.5}$$

For the case of three dimensional space, we simply use the generalized taxicab sphere instead of the generalized taxicab circle, with the same approach. The generalized taxicab distance from a point to a plane or a line is equal to the radius of the expanding generalized taxicab sphere when the plane or the line becomes tangent to the generalized taxicab sphere. The following proposition gives the formula for the generalized taxicab distance between a point and a plane, with an equation which relates the Euclidean distance to the generalized taxicab distance between a point and a plane in three dimensional space:

**Proposition 2.6** *The generalized taxicab distance between a point  $P = (x_0, y_0, z_0)$  and a plane  $\Pi : Ax + By + Cz + D = 0$  in  $\mathbb{R}^3$  is*

$$d_{T_g}(P, \Pi) = \frac{|Ax_0 + By_0 + Cz_0 + D|}{\max\{|A/\lambda_1|, |B/\lambda_2|, |C/\lambda_3|\}}. \tag{2.6}$$

In addition,

$$\frac{d_E(P, \Pi)}{d_{T_g}(P, \Pi)} = \frac{\max\{|A/\lambda_1|, |B/\lambda_2|, |C/\lambda_3|\}}{(A^2 + B^2 + C^2)^{1/2}}. \tag{2.7}$$

**Proof** Clearly, the generalized taxicab distance between the point  $P$  and the plane  $\Pi$  is

$$d_{T_g}(P, \Pi) = \min\{d_{T_g}(P, X) : X \in \Pi\},$$

which is equal to the radius of the generalized taxicab sphere with center  $P$ , such that the plane  $\Pi$  is tangent to it. Then, at least one vertex of the generalized taxicab sphere is on  $\Pi$ , which is also on one of the lines through  $P$  and parallel to a coordinate axis. In other words, if  $\ell_x$ ,  $\ell_y$  and  $\ell_z$  denote the lines passing through  $P$  and parallel to  $x$ ,  $y$  and  $z$  axis respectively, then there exists at least one of the points

$$Q_1 = \Pi \cap \ell_x, \quad Q_2 = \Pi \cap \ell_y \quad \text{and} \quad Q_3 = \Pi \cap \ell_z,$$

which can be expressed by  $Q_1 = (x_{Q_1}, y_0, z_0)$ ,  $Q_2 = (x_0, y_{Q_2}, z_0)$ ,  $Q_3 = (x_0, y_0, z_{Q_3})$ , such that  $\Pi$  is tangent to the generalized taxicab sphere at least one of them (see Figure 8).

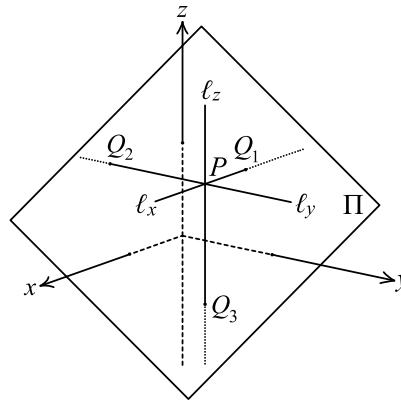

Figure 8.

Thus, we have

$$d_{T_g}(P, \Pi) = \min\{d_{T_g}(P, Q_1), d_{T_g}(P, Q_2), d_{T_g}(P, Q_3)\}.$$

For the case  $A \neq 0$ ,  $B \neq 0$  and  $C \neq 0$ , all of the points  $Q_1$ ,  $Q_2$  and  $Q_3$  exist and we obtain

$$d_{T_g}(P, Q_1) = \lambda_1 |x_0 - x_{Q_1}| = \lambda_1 \left| x_0 - \frac{-By_0 - Cz_0 - D}{A} \right| = \frac{|Ax_0 + By_0 + Cz_0 + D|}{|A/\lambda_1|}$$

and similarly

$$d_{T_g}(P, Q_2) = \frac{|Ax_0 + By_0 + Cz_0 + D|}{|B/\lambda_2|} \text{ and } d_{T_g}(P, Q_3) = \frac{|Ax_0 + By_0 + Cz_0 + D|}{|C/\lambda_3|}.$$

Then, we have

$$d_{T_g}(P, \Pi) = \min \left\{ \frac{|Ax_0 + By_0 + Cz_0 + D|}{|A/\lambda_1|}, \frac{|Ax_0 + By_0 + Cz_0 + D|}{|B/\lambda_2|}, \frac{|Ax_0 + By_0 + Cz_0 + D|}{|C/\lambda_3|} \right\},$$

and so

$$d_{T_g}(P, \Pi) = \frac{|Ax_0 + By_0 + Cz_0 + D|}{\max \{|A/\lambda_1|, |B/\lambda_2|, |C/\lambda_3|\}}.$$

Other cases affect only existence of points  $Q_1$ ,  $Q_2$ ,  $Q_3$ , and do not change the conclusion. Besides, since

$$d_E(P, \Pi) = \frac{|Ax_0 + By_0 + Cz_0 + D|}{(A^2 + B^2 + C^2)^{1/2}},$$

we have equation (2.7). □

**Remark 2.7** Notice that the nearest point or points on the plane  $\Pi$ , to  $P$ , in the generalized taxicab sense, are the points of tangency of  $\Pi$  to the generalized taxicab sphere with center  $P$  and radius  $d_{T_g}(P, \Pi)$ . Thus, either there is only one nearest point or there are infinitely many nearest points on a plane to a point (see Figure 6).

Clearly, two distinct planes either intersect or are parallel, and the generalized taxicab distance between two intersecting planes is 0. The following corollary which follows directly from Proposition 2.6, gives the formula for the generalized taxicab distance between two parallel planes, with an equation which relates the Euclidean distance to the generalized taxicab distance between two parallel planes in three dimensional space:



**Corollary 2.8** *The generalized taxicab distance between two parallel planes  $\Pi_1 : Ax + By + Cz + D_1 = 0$  and  $\Pi_2 : Ax + By + Cz + D_2 = 0$  in  $\mathbb{R}^3$  is*

$$d_{T_g}(\Pi_1, \Pi_2) = \frac{|D_1 - D_2|}{\max\{|A/\lambda_1|, |B/\lambda_2|, |C/\lambda_3|\}}. \tag{2.8}$$

In addition,

$$\frac{d_E(\Pi_1, \Pi_2)}{d_{T_g}(\Pi_1, \Pi_2)} = \frac{\max\{|A/\lambda_1|, |B/\lambda_2|, |C/\lambda_3|\}}{(A^2 + B^2 + C^2)^{1/2}}. \tag{2.9}$$

Note that a plane and a line which does not lie on this plane, either intersect or are parallel, and if the line intersects with the plane the generalized taxicab distance between the line and the plane is 0. Clearly, if the line is parallel to the plane, then the generalized taxicab distance from any point on the line to the plane is constant. Thus, one can find the generalized taxicab distance between the line and the plane by calculating the generalized taxicab distance from any point on the line to the plane.

The following proposition gives the formula for the generalized taxicab distance between a point and a line, with an equation which relates the Euclidean distance to the generalized taxicab distance between a point and a line in three dimensional space:

**Proposition 2.9** *The generalized taxicab distance between a point  $P = (x_0, y_0, z_0)$  and a line  $\ell$  passing through  $P_1 = (x_1, y_1, z_1)$  and parallel to the vector  $\vec{u} = (u_1, u_2, u_3)$  in  $\mathbb{R}^3$  is*

$$d_{T_g}(P, \ell) = \min_{\substack{i,j,k \in \{1,2,3\} \\ i \neq j \neq k \neq i}} \left\{ \lambda_i \left| \rho_i - \frac{u_i}{u_k} \rho_k \right| + \lambda_j \left| \rho_j - \frac{u_j}{u_k} \rho_k \right| \right\}, \tag{2.10}$$

where  $\rho_1 = (x_0 - x_1)$ ,  $\rho_2 = (y_0 - y_1)$  and  $\rho_3 = (z_0 - z_1)$ . In addition,

$$\frac{d_E(P, \ell)}{d_{T_g}(P, \ell)} = \frac{\sqrt{((u_2\rho_1 - u_1\rho_2)^2 + (u_3\rho_1 - u_1\rho_3)^2 + (u_3\rho_2 - u_2\rho_3)^2)}}{\sqrt{(u_1^2 + u_2^2 + u_3^2)} \min_{\substack{i,j,k \in \{1,2,3\} \\ i \neq j \neq k \neq i}} \left\{ \lambda_i \left| \rho_i - \frac{u_i}{u_k} \rho_k \right| + \lambda_j \left| \rho_j - \frac{u_j}{u_k} \rho_k \right| \right\}}. \tag{2.11}$$

**Proof** Clearly, the generalized taxicab distance between the point  $P$  and the line  $\ell$  is

$$d_{T_g}(P, \ell) = \min \{d_{T_g}(P, X) : X \in \ell\},$$

which is equal to the radius of the generalized taxicab sphere with center  $P$  such that the line  $\ell$  is tangent to it. Observe that if the line  $\ell$  is tangent to this generalized taxicab sphere, at least one point on an edge of the sphere is on  $\ell$ , which is also on one of the planes through  $P$  and perpendicular to a coordinate axis. In other words, if  $\Pi_x$ ,  $\Pi_y$ , and  $\Pi_z$  denote the planes through  $P$  and perpendicular to  $x$ ,  $y$ , and  $z$  axis, respectively, then there exists at least one of the points

$$R_1 = \ell \cap \Pi_x, \quad R_2 = \ell \cap \Pi_y \quad \text{and} \quad R_3 = \ell \cap \Pi_z,$$

which can be expressed by  $R_1 = (x_0, y_{R_1}, z_{R_1})$ ,  $R_2 = (x_{R_2}, y_0, z_{R_2})$ ,  $R_3 = (x_{R_3}, y_{R_3}, z_0)$ , such that  $\ell$  is tangent to the generalized taxicab sphere at one of them (see Figure 9).

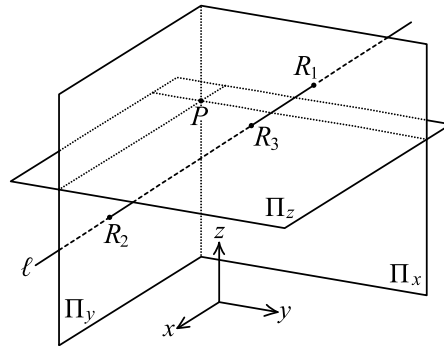

Figure 9.

Thus, we have

$$d_{T_g}(P, \ell) = \min\{d_{T_g}(P, R_1), d_{T_g}(P, R_2), d_{T_g}(P, R_3)\}.$$

For the case of  $u_1 \neq 0$ ,  $u_2 \neq 0$ , and  $u_3 \neq 0$ , all of the points  $R_1$ ,  $R_2$ , and  $R_3$  exist and we get that

$$\begin{aligned} d_{T_g}(P, R_1) &= \lambda_2 |y_0 - y_{R_1}| + \lambda_3 |z_0 - z_{R_1}| \\ &= \lambda_2 \left| y_0 - \frac{u_1 y_1 + u_2(x_0 - x_1)}{u_1} \right| + \lambda_3 \left| z_0 - \frac{u_1 z_1 + u_3(x_0 - x_1)}{u_1} \right| \\ &= \lambda_2 \left| (y_0 - y_1) - \frac{u_2}{u_1}(x_0 - x_1) \right| + \lambda_3 \left| (z_0 - z_1) - \frac{u_3}{u_1}(x_0 - x_1) \right| \\ &= \lambda_2 \left| \rho_2 - \frac{u_2}{u_1} \rho_1 \right| + \lambda_3 \left| \rho_3 - \frac{u_3}{u_1} \rho_1 \right|, \end{aligned}$$

where  $\rho_1 = (x_0 - x_1)$ ,  $\rho_2 = (y_0 - y_1)$  and  $\rho_3 = (z_0 - z_1)$ . Similarly, we can obtain

$$\begin{aligned} d_{T_g}(P, R_2) &= \lambda_1 \left| \rho_1 - \frac{u_1}{u_2} \rho_2 \right| + \lambda_3 \left| \rho_3 - \frac{u_3}{u_2} \rho_2 \right|, \\ d_{T_g}(P, R_3) &= \lambda_1 \left| \rho_1 - \frac{u_1}{u_3} \rho_3 \right| + \lambda_2 \left| \rho_2 - \frac{u_2}{u_3} \rho_3 \right|. \end{aligned}$$

Thus, we have

$$d_{T_g}(P, \ell) = \min_{\substack{i,j,k \in \{1,2,3\} \\ i \neq j \neq k \neq i}} \left\{ \lambda_i \left| \rho_i - \frac{u_i}{u_k} \rho_k \right| + \lambda_j \left| \rho_j - \frac{u_j}{u_k} \rho_k \right| \right\}.$$

Other cases affect only existence of points  $R_1$ ,  $R_2$ ,  $R_3$ , and do not change the conclusion. Besides, since

$$\begin{aligned} d_E(P, \ell) &= \frac{\|(u_1, u_2, u_3) \times (x_0 - x_1, y_0 - y_1, z_0 - z_1)\|}{\|(u_1, u_2, u_3)\|} \\ &= \frac{\sqrt{((u_2 \rho_1 - u_1 \rho_2)^2 + (u_3 \rho_1 - u_1 \rho_3)^2 + (u_3 \rho_2 - u_2 \rho_3)^2)}}{\sqrt{u_1^2 + u_2^2 + u_3^2}}, \end{aligned}$$

where  $\rho_1 = (x_0 - x_1)$ ,  $\rho_2 = (y_0 - y_1)$ ,  $\rho_3 = (z_0 - z_1)$ , one gets equation (2.11). □

**Remark 2.10** Notice that the nearest point or points on the line  $\ell$  to the point  $P$ , in the generalized taxicab sense, are the points of tangency of the line  $\ell$  to the generalized taxicab sphere with center  $P$  and radius  $d_{T_g}(P, \ell)$ . Observe that either there is only one nearest point or there are infinitely many nearest points on a line to a point (see Figure 6).

The following is an application of equation (2.10):

**Example 2.11** Let us find the generalized taxicab distance between the point  $P = (1, 2, 5)$  and the line passing through  $P_1 = (-1, 0, 2)$  and parallel to the vector  $\vec{u} = (1, 2, 1)$  in  $\mathbb{R}^3$ . Substituting values into equation (2.10), one gets  $\rho_1 = 2, \rho_2 = 2, \rho_3 = 3$  and

$$d_{T_g}(P, \ell) = \min\{2\lambda_2 + \lambda_3, \lambda_1 + 2\lambda_3, \lambda_1 + 4\lambda_2\}.$$

In fact,  $\Pi_x : x = 1, \Pi_y : y = 2, \Pi_z : z = 5, \ell : \alpha(t) = (-1 + t, 2t, 2 + t), R_1 = (1, 4, 4), R_2 = (0, 2, 3), R_3 = (2, 6, 5)$ . Thus,

$$d_{T_g}(P, R_1) = 2\lambda_2 + \lambda_3, \quad d_{T_g}(P, R_2) = \lambda_1 + 2\lambda_3, \quad d_{T_g}(P, R_3) = \lambda_1 + 4\lambda_2,$$

and we get

$$d_{T_g}(P, \ell) = \min\{2\lambda_2 + \lambda_3, \lambda_1 + 2\lambda_3, \lambda_1 + 4\lambda_2\}.$$

Clearly, two distinct lines either intersect or are parallel which are coplanar and do not intersect or are skew which are not coplanar and do not intersect, and the generalized taxicab distance between two intersecting lines is 0. The following corollary that follows directly from Proposition 2.9, gives the formula for the generalized taxicab distance between two parallel lines, with an equation which relates the Euclidean distance to the generalized taxicab distance between two parallel lines, in three dimensional space:

**Corollary 2.12** Let  $\ell_1$  and  $\ell_2$  be two parallel lines whose equations are

$$\begin{aligned} \ell_1 & : \alpha_1(t) = (x_1, y_1, z_1) + t(u_1, u_2, u_3), \\ \ell_2 & : \alpha_2(t) = (x_2, y_2, z_2) + t(u_1, u_2, u_3). \end{aligned}$$

The generalized taxicab distance between  $\ell_1$  and  $\ell_2$  is

$$d_{T_g}(\ell_1, \ell_2) = \min_{\substack{i,j,k \in \{1,2,3\} \\ i \neq j \neq k \neq i}} \left\{ \lambda_i \left| \rho_i - \frac{u_i}{u_k} \rho_k \right| + \lambda_j \left| \rho_j - \frac{u_j}{u_k} \rho_k \right| \right\}, \tag{2.12}$$

where  $\rho_1 = (x_1 - x_2), \rho_2 = (y_1 - y_2), \rho_3 = (z_1 - z_2)$ . In addition,

$$\frac{d_E(\ell_1, \ell_2)}{d_{T_g}(\ell_1, \ell_2)} = \frac{\sqrt{((u_2\rho_1 - u_1\rho_2)^2 + (u_3\rho_1 - u_1\rho_3)^2 + (u_3\rho_2 - u_2\rho_3)^2)}}{\sqrt{u_1^2 + u_2^2 + u_3^2} \min_{\substack{i,j,k \in \{1,2,3\} \\ i \neq j \neq k \neq i}} \left\{ \lambda_i \left| \rho_i - \frac{u_i}{u_k} \rho_k \right| + \lambda_j \left| \rho_j - \frac{u_j}{u_k} \rho_k \right| \right\}}. \tag{2.13}$$

The following proposition gives the formula for the generalized taxicab distance between two skew lines, with an equation which relates the Euclidean distance to the generalized taxicab distance between two skew lines, in three dimensional space:

**Proposition 2.13** Let  $\ell_1$  and  $\ell_2$  be two skew lines whose equations are

$$\begin{aligned} \ell_1 & : \beta_1(t) = (x_1, y_1, z_1) + t(u_1, u_2, u_3), \\ \ell_2 & : \beta_2(t) = (x_2, y_2, z_2) + t(v_1, v_2, v_3). \end{aligned}$$

Then, the generalized taxicab distance between the lines  $\ell_1$  and  $\ell_2$  is

$$d_{T_g}(\ell_1, \ell_2) = \frac{|(x_1 - x_2)\delta_{(2,3)} + (y_1 - y_2)\delta_{(3,1)} + (z_1 - z_2)\delta_{(1,2)}|}{\max\{|\delta_{(2,3)}/\lambda_1|, |\delta_{(3,1)}/\lambda_2|, |\delta_{(1,2)}/\lambda_3|\}}, \tag{2.14}$$

where  $\delta_{(a,b)} = u_a v_b - u_b v_a$ . In addition,

$$\frac{d_E(\ell_1, \ell_2)}{d_{T_g}(\ell_1, \ell_2)} = \frac{\max\{|\delta_{(2,3)}/\lambda_1|, |\delta_{(3,1)}/\lambda_2|, |\delta_{(1,2)}/\lambda_3|\}}{(\delta_{(2,3)}^2 + \delta_{(3,1)}^2 + \delta_{(1,2)}^2)^{1/2}}. \tag{2.15}$$

**Proof** Clearly, if lines  $\ell_1$  and  $\ell_2$  are skew, then there is only one plane  $\Pi$  passing through the line  $\ell_2$  and parallel to the line  $\ell_1$ , which can be constructed by the line  $\ell_2$  and a line  $\ell'_1$  which intersects with  $\ell_2$  at any point and is parallel to  $\ell_1$ . Then, we have

$$d_{T_g}(\ell_1, \Pi) = d_{T_g}(P_1, \Pi).$$

Observe that  $\ell_2$  is tangent to one of the generalized taxicab spheres whose centers are on the line  $\ell_1$ , to which the plane  $\Pi$  is tangent, and this generalized taxicab sphere has minimum radius among those whose centers are on the line  $\ell_1$  to which the line  $\ell_2$  is tangent (see Figure 10). Therefore, we have

$$d_{T_g}(\ell_1, \ell_2) = d_{T_g}(P_1, \Pi)$$

for the point  $P_1 = (x_1, y_1, z_1)$  on the line  $\ell_1$ .

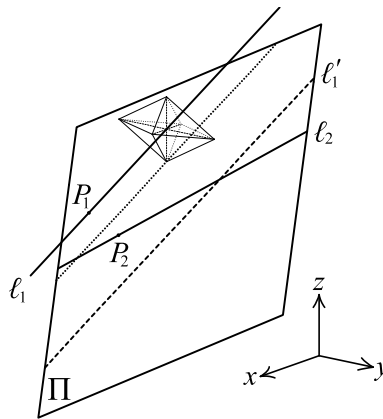

**Figure 10.**

Then, since

$$\langle P_2 X, (u_1, u_2, u_3) \times (v_1, v_2, v_3) \rangle = 0$$

for points  $X = (x, y, z)$  and  $P_2 = (x_2, y_2, z_2)$  on the plane  $\Pi$ , one can easily find the equation of the plane  $\Pi$  as

$$(x - x_2)\delta_{(2,3)} + (y - y_2)\delta_{(3,1)} + (z - z_2)\delta_{(1,2)} = 0,$$

where  $\delta_{(a,b)} = u_a v_b - u_b v_a$ . Thus, by Proposition 2.6, one gets

$$d_{T_g}(\ell_1, \ell_2) = d_{T_g}(P_1, \Pi) = \frac{|(x_1 - x_2)\delta_{(2,3)} + (y_1 - y_2)\delta_{(3,1)} + (z_1 - z_2)\delta_{(1,2)}|}{\max\{|\delta_{(2,3)}/\lambda_1|, |\delta_{(3,1)}/\lambda_2|, |\delta_{(1,2)}/\lambda_3|\}}.$$

Besides, since

$$d_E(\ell_1, \ell_2) = \frac{|(x_1 - x_2)\delta_{(2,3)} + (y_1 - y_2)\delta_{(3,1)} + (z_1 - z_2)\delta_{(1,2)}|}{(\delta_{(2,3)}^2 + \delta_{(3,1)}^2 + \delta_{(1,2)}^2)^{1/2}}$$

we have equation (2.15). □

**Remark 2.14** *Clearly, we can make two skew lines  $\ell_1$  and  $\ell_2$  intersect, by translating one of them along a coordinate axis which is not parallel to them. Thus, if the lines  $\ell_1$  and  $\ell_2$  are not parallel to coordinate axes, then we make the skew lines  $\ell_1$  and  $\ell_2$  intersect, by translating one of them along any coordinate axis. Observe that the shortest generalized taxicab distance between the skew lines  $\ell_1$  and  $\ell_2$ , is equal to the minimum of the weighted amounts of translations along coordinate axes. In other words, if  $\ell_1$  and  $\ell_2$  are not parallel to coordinate axes, we get three pairs of points  $(X_1, X_2)$ ,  $(Y_1, Y_2)$  and  $(Z_1, Z_2)$  on mutual lines, by translating each of the lines along coordinate axes  $x$ ,  $y$ , and  $z$  respectively, such that  $\ell_1$  and  $\ell_2$  intersect at them. Then, we have*

$$d_{T_g}(\ell_1, \ell_2) = \min\{d_{T_g}(X_1, X_2), d_{T_g}(Y_1, Y_2), d_{T_g}(Z_1, Z_2)\}.$$

*Notice that pairs of points  $(X_1, X_2)$ ,  $(Y_1, Y_2)$ , and  $(Z_1, Z_2)$  are also determine the nearest pairs of points, in the generalized taxicab sense. Observe that when the lines  $\ell_1$  and  $\ell_2$  are not parallel to coordinate axes, if the generalized taxicab distances between these pairs of points are different, then there is only one nearest pair of points, having the minimum generalized taxicab distance, otherwise there are infinitely many nearest pairs of points on mutual lines.*

The following is an application of equation (2.14):

**Example 2.15** *Let us find the generalized taxicab distance between two skew lines  $\ell_1 : \beta_1(t_1) = (0, 2, 2) + t_1(1, 2, 1)$  and  $\ell_2 : \beta_2(t_2) = (-2, 1, 4) + t_2(-1, 0, 3)$  in  $\mathbb{R}^3$ . Substituting values into equation (2.14), one gets  $\delta_{(2,3)} = 6$ ,  $\delta_{(3,1)} = -4$ ,  $\delta_{(1,2)} = 2$ , and*

$$d_{T_g}(\ell_1, \ell_2) = \frac{4}{\max\{6/\lambda_1, 4/\lambda_2, 2/\lambda_3\}} = \min\{\frac{2}{3}\lambda_1, \lambda_2, 2\lambda_3\}.$$

*In fact, the plane  $\Pi$  passing through the line  $\ell_2$  and parallel to the line  $\ell_1$ , has the equation*

$$6x - 4y + 2z + 8 = 0,$$

*and by Proposition 2.6, one gets*

$$d_{T_g}(\ell_1, \ell_2) = d_{T_g}(P_1, \Pi) = \frac{4}{\max\{6/\lambda_1, 4/\lambda_2, 2/\lambda_3\}} = \min\{\frac{2}{3}\lambda_1, \lambda_2, 2\lambda_3\}.$$

*Notice that one can get the same result by using the concept given in Remark 2.14: Consider the following translations along coordinate axes*

$$T_x : (x, y, z) \rightarrow (x + c_1, y, z), T_y : (x, y, z) \rightarrow (x, y + c_2, z), T_z : (x, y, z) \rightarrow (x, y, z + c_3),$$

which make the image of, let say  $\ell_2$ , intersect with  $\ell_1$ . Then, one can obtain that  $c_1 = \frac{2}{3}$ ,  $c_2 = -1$  and  $c_3 = 2$ , and so

$$d_{T_g}(\ell_1, \ell_2) = \min \{ \lambda_1 |c_1|, \lambda_2 |c_2|, \lambda_3 |c_3| \} = \min \{ \frac{2}{3} \lambda_1, \lambda_2, 2\lambda_3 \}.$$

Using  $t_1$  and  $t_2$  values which we derive while we obtain  $c_i$  values, one can also find the pairs of points  $(X_1, X_2)$ ,  $(Y_1, Y_2)$ , and  $(Z_1, Z_2)$  defined in Remark 2.14, as follows

$$X_1 = (-\frac{1}{2}, 1, \frac{3}{2}), X_2 = (-\frac{7}{6}, 1, \frac{3}{2}), Y_1 = (-1, 0, 1), Y_2 = (-1, 1, 1), Z_1 = (-\frac{1}{2}, 1, \frac{3}{2}), Z_2 = (-\frac{1}{2}, 1, -\frac{1}{2}).$$

Thus, for example if  $\lambda_1 = \lambda_2 = \lambda_3 = 1$ , then it is obvious that the nearest pair of points on mutual lines is  $(X_1, X_2)$ .

Clearly, if  $\lambda_1 = \lambda_2 = \lambda_3 = 1$ , then the taxicab distance formulae are obtained in three dimensional space with different approaches and proofs from those given in [1].

### 3. Generalized taxicab distance formulae in $\mathbb{R}^n$

In this section, we determine generalized taxicab distance formulae from a point to a plane and a line in  $n$ -dimensional space, by generalizing the sphere-tangent concept to  $n$ -dimensional space. Then, we determine generalized taxicab distance formula between two skew lines in  $n$ -dimensional space, by using translations along coordinate axes. First, let us give the generalized taxicab distance between two points in  $n$ -dimensional space:

**Definition 3.1** Let  $X = (x_1, \dots, x_n)$  and  $Y = (y_1, \dots, y_n)$  be two points in  $\mathbb{R}^n$ . For positive real numbers  $\lambda_1, \dots, \lambda_n$ , the function  $d_{T_g} : \mathbb{R}^n \times \mathbb{R}^n \rightarrow [0, \infty)$  defined by

$$d_{T_g}(X, Y) = \sum_{i=1}^n \lambda_i |x_i - y_i| \tag{3.1}$$

is called **generalized taxicab distance function** in  $\mathbb{R}^n$ , and the real number  $d_{T_g}(X, Y)$  is called **generalized taxicab distance** between points  $X$  and  $Y$ .

Since the generalized taxicab metric in  $\mathbb{R}^n$  can be induced by the norm

$$\|x\|_{T_g} = \sum_{i=1}^n \lambda_i |x_i|, \tag{3.2}$$

it generates convex hyperspheres in  $n$ -dimensional space. Therefore, we can use the same sphere-tangent concept to find the generalized taxicab distance formulae from a point to a plane or a line in  $\mathbb{R}^n$ . Thus, in  $\mathbb{R}^n$  we say that a hyperplane or a line is tangent to a given generalized taxicab hypersphere with center  $P$  and radius  $r$ , if its generalized taxicab distance from  $P$  is  $r$ . Clearly, the unit generalized taxicab hypersphere is the set of all points  $(x_1, \dots, x_n)$  in  $\mathbb{R}^n$ , satisfying the equation

$$\sum_{i=1}^n \lambda_i |x_i| = 1, \tag{3.3}$$

and it has  $2n$  vertices:  $V_1 = (1/\lambda_1, \dots, 0)$ ,  $V'_1 = (-1/\lambda_1, \dots, 0)$ , ... ,  $V_n = (0, \dots, 1/\lambda_n)$ ,  $V'_n = (0, \dots, -1/\lambda_n)$ .

The following proposition gives the formula for the generalized taxicab distance between a point and a plane in  $n$ -dimensional space:

**Proposition 3.2** *The generalized taxicab distance between a point  $P = (x_{1(0)}, \dots, x_{n(0)})$  and a hyperplane*

$\Pi : \sum_{i=1}^n A_i x_i + B = 0$  *in  $\mathbb{R}^n$  is*

$$d_{T_g}(P, \Pi) = \frac{\left| \sum_{i=1}^n A_i x_{i(0)} + B \right|}{\max_{i \in \{1, \dots, n\}} \{|A_i/\lambda_i|\}}. \tag{3.4}$$

**Proof** Clearly, the generalized taxicab distance between the point  $P$  and the hyperplane  $\Pi$  is

$$d_{T_g}(P, \Pi) = \min \{d_{T_g}(P, X) : X \in \Pi\}.$$

which is equal to the radius of the generalized taxicab hypersphere with center  $P$ , such that the hyperplane  $\Pi$  is tangent to it. Then, at least one vertex of the generalized taxicab hypersphere is on  $\Pi$ , which is also on one of the lines through  $P$  and parallel to a coordinate axis. In other words, if  $\ell_{x_i}$  denotes the line passing through  $P$  and parallel to  $x_i$ -axis for  $i \in \{1, \dots, n\}$ , then there exists at least one of the points

$$Q_i = \Pi \cap \ell_{x_i},$$

which can be expressed by  $Q_i = (x_{1(0)}, \dots, x_{i-1(0)}, x_{i(Q_i)}, x_{i+1(0)}, \dots, x_{n(0)})$ , such that  $\Pi$  is tangent to the generalized taxicab hypersphere at one of them. Thus, we have

$$d_{T_g}(P, \Pi) = \min_{i \in \{1, \dots, n\}} \{d_{T_g}(P, Q_i)\}.$$

For the case  $A_i \neq 0, i \in \{1, \dots, n\}$ , every point  $Q_i$  exists and we obtain

$$\begin{aligned} d_{T_g}(P, Q_i) &= \lambda_i |x_{i(0)} - x_{i(Q_i)}| \\ &= \lambda_i \left| x_{i(0)} - \frac{-A_1 x_{1(0)} - \dots - A_{i-1} x_{i-1(0)} - A_{i+1} x_{i+1(0)} - \dots - A_n x_{n(0)} - B}{A_i} \right| \\ &= \frac{|A_1 x_{1(0)} + \dots + A_n x_{n(0)} + B|}{|A_i/\lambda_i|}. \end{aligned}$$

Then, we have

$$d_{T_g}(P, \Pi) = \min_{i \in \{1, \dots, n\}} \left\{ \frac{\left| \sum_{i=1}^n A_i x_{i(0)} + B \right|}{|A_i/\lambda_i|} \right\} = \frac{\left| \sum_{i=1}^n A_i x_{i(0)} + B \right|}{\max_{i \in \{1, \dots, n\}} \{|A_i/\lambda_i|\}}.$$

Other cases affect only existence of points  $Q_i$ , and do not change the conclusion. □

The following proposition gives the formula for the generalized taxicab distance between a point and a line in  $n$ -dimensional space:

**Proposition 3.3** *The generalized taxicab distance between a point  $P = (x_{1(0)}, \dots, x_{n(0)})$  and a line  $\ell$  passing through  $P_1 = (x_{1(1)}, \dots, x_{n(1)})$  and parallel to the vector  $\vec{u} = (u_1, \dots, u_n)$  in  $\mathbb{R}^n$  is*

$$d_{T_g}(P, \ell) = \min_{i \in \{1, \dots, n\}} \left\{ \sum_{j \in \{1, \dots, n\} \setminus \{i\}} \lambda_j \left| (x_{j(0)} - x_{j(1)}) - \frac{u_j}{u_i} (x_{i(0)} - x_{i(1)}) \right| \right\}. \tag{3.5}$$

**Proof** Clearly, the generalized taxicab distance between the point  $P$  and the line  $\ell$  is

$$d_{T_g}(P, \ell) = \min \{d_{T_g}(P, X) : X \in \ell\},$$

which is equal to the radius of the generalized taxicab hypersphere with center  $P$ , such that the line  $\ell$  is tangent to it. If a generalized taxicab hypersphere tangent to a line, at least one point on an edge is on  $\ell$ , which is also on one of the hyperplanes through  $P$  and perpendicular to a coordinate axis. In other words, if  $\Pi_{x_i}$  denotes the plane through  $P$  and perpendicular to  $x_i$ -axis for  $i \in \{1, \dots, n\}$ , then there exists at least one of the points

$$R_i = \ell \cap \Pi_{x_i},$$

which can be expressed by  $R_i = (x_{1(R_i)}, \dots, x_{i-1(R_i)}, x_{i(0)}, x_{i+1(R_i)}, \dots, x_{n(R_i)})$ , such that  $\ell$  is tangent to the generalized taxicab hypersphere at one of them. Thus, we have

$$d_{T_g}(P, \ell) = \min_{i \in \{1, \dots, n\}} \{d_{T_g}(P, R_i)\}.$$

For the case  $u_i \neq 0, i \in \{1, \dots, n\}$ , every point  $R_i$  exists and we find

$$\begin{aligned} d_{T_g}(P, R_i) &= \sum_{j \in \{1, \dots, n\} \setminus \{i\}} \lambda_j |x_{j(0)} - x_{j(R_i)}| \\ &= \sum_{j \in \{1, \dots, n\} \setminus \{i\}} \lambda_j \left| x_{j(0)} - \left( x_{j(1)} + \frac{u_j(x_{i(0)} - x_{i(1)})}{u_i} \right) \right| \\ &= \sum_{j \in \{1, \dots, n\} \setminus \{i\}} \lambda_j \left| (x_{j(0)} - x_{j(1)}) - \frac{u_j}{u_i} (x_{i(0)} - x_{i(1)}) \right|. \end{aligned}$$

Thus, we have

$$d_{T_g}(P, \ell) = \min_{i \in \{1, \dots, n\}} \left\{ \sum_{j \in \{1, \dots, n\} \setminus \{i\}} \lambda_j \left| (x_{j(0)} - x_{j(1)}) - \frac{u_j}{u_i} (x_{i(0)} - x_{i(1)}) \right| \right\}.$$

Other cases affect only existence of points  $R_i$ , and do not change the conclusion. □

Since cross product of two vectors in  $n$ -dimensional space is not defined, we cannot follow the way used in Proposition 2.13 to give the generalized taxicab distance between two skew lines. However, we can generalize the way mentioned in Remark 2.14 to  $n$ -dimensional space as follows: Consider two skew lines with equations

$$\begin{aligned} \ell_1 &: \gamma_1(t_1) = (x_{1(1)}, \dots, x_{n(1)}) + t_1(u_1, \dots, u_n), \\ \ell_2 &: \gamma_2(t_2) = (x_{1(2)}, \dots, x_{n(2)}) + t_2(v_1, \dots, v_n), \end{aligned}$$

and let us denote by  $\ell'_2$ , the image of the line  $\ell_2$  under the translation

$$T : (x_1, \dots, x_n) \rightarrow (x_1 + c_1, \dots, x_n + c_n).$$

Here,  $T$  can also be seen as the composition of translations along  $n$  coordinate axes, such that  $|c_i|$  is the amount of the translation along the coordinate axis  $x_i$ . If the lines  $\ell_1$  and  $\ell'_2$  intersect, then the following system of  $n$  linear equations in two variables has unique solution:

$$\begin{bmatrix} t_1 u_1 - t_2 v_1 \\ \vdots \\ t_1 u_n - t_2 v_n \end{bmatrix} = \begin{bmatrix} x_{1(2)} - x_{1(1)} + c_1 \\ \vdots \\ x_{n(2)} - x_{n(1)} + c_n \end{bmatrix}.$$



Clearly, if two of  $c_i$  values are equal to 0, then the system has unique solution. Thus, we can state that one makes two skew lines  $\ell_1$  and  $\ell_2$  intersect, by translating one of them along  $(n - 2)$  coordinate axes which are not parallel to them. Therefore, if the lines  $\ell_1$  and  $\ell_2$  are not parallel to coordinate axes, then translations can be along any  $(n - 2)$  of coordinate axis. Thus, the shortest generalized taxicab distance between the skew lines  $\ell_1$  and  $\ell_2$ , is the minimum of the sum of weighted amounts of translations along any  $(n - 2)$  coordinate axes.

Now, the following proposition gives the formula for the generalized taxicab distance between two skew lines in  $n$ -dimensional space:

**Proposition 3.4** *Let  $\ell_1$  and  $\ell_2$  be two skew lines whose equations are*

$$\begin{aligned} \ell_1 & : \gamma_1(t_1) = (x_{1(1)}, \dots, x_{n(1)}) + t_1(u_1, \dots, u_n), \\ \ell_2 & : \gamma_2(t_2) = (x_{1(2)}, \dots, x_{n(2)}) + t_2(v_1, \dots, v_n). \end{aligned}$$

*Then, the generalized taxicab distance between the lines  $\ell_1$  and  $\ell_2$  is*

$$d_{T_g}(\ell_1, \ell_2) = \min_{\substack{i, j \in \{1, \dots, n\} \\ i \neq j}} \left\{ \sum_{k \in \{1, \dots, n\} \setminus \{i, j\}} \left| \frac{(x_{k(1)} - x_{k(2)}) \delta_{(i,j)} + (x_{i(1)} - x_{i(2)}) \delta_{(j,k)} + (x_{j(1)} - x_{j(2)}) \delta_{(k,i)}}{\delta_{(i,j)} / \lambda_k} \right| \right\}, \tag{3.6}$$

where  $\delta_{(a,b)} = u_a v_b - u_b v_a$  for  $a, b \in \{1, \dots, n\}$  and  $a \neq b$ .

**Proof** Let us consider translation  $T : (x_1, \dots, x_n) \rightarrow (x_1 + c_1, \dots, x_n + c_n)$  such that  $c_i = c_j = 0$  for  $i, j \in \{1, \dots, n\}$  and  $i \neq j$ , which is the composition of translations along  $(n - 2)$  coordinate axes different from  $x_i$  and  $x_j$ . Then we have

$$\begin{aligned} t_1 u_i - t_2 v_i & = x_{i(2)} - x_{i(1)}, \\ t_1 u_j - t_2 v_j & = x_{j(2)} - x_{j(1)}. \end{aligned}$$

Solving this system of equations, we obtain

$$t_1 = \frac{v_j(x_{i(2)} - x_{i(1)}) - v_i(x_{j(2)} - x_{j(1)})}{(u_i v_j - u_j v_i)} \quad \text{and} \quad t_2 = \frac{u_j(x_{i(2)} - x_{i(1)}) - u_i(x_{j(2)} - x_{j(1)})}{(u_i v_j - u_j v_i)}$$

and so

$$\lambda_k |c_k| = \left| \frac{(x_{k(1)} - x_{k(2)}) \delta_{(i,j)} + (x_{i(1)} - x_{i(2)}) \delta_{(j,k)} + (x_{j(1)} - x_{j(2)}) \delta_{(k,i)}}{\delta_{(i,j)} / \lambda_k} \right|$$

for  $k \in \{1, \dots, n\} \setminus \{i, j\}$ , where  $\delta_{(a,b)} = u_a v_b - u_b v_a$  for  $a, b \in \{1, \dots, n\}$  and  $a \neq b$ . Then, we have the generalized taxicab distance between the skew lines  $\ell_1$  and  $\ell_2$  as follows

$$d_{T_g}(\ell_1, \ell_2) = \min_{\substack{i, j \in \{1, \dots, n\} \\ i \neq j}} \left\{ \sum_{k \in \{1, \dots, n\} \setminus \{i, j\}} \left| \frac{(x_{k(1)} - x_{k(2)}) \delta_{(i,j)} + (x_{i(1)} - x_{i(2)}) \delta_{(j,k)} + (x_{j(1)} - x_{j(2)}) \delta_{(k,i)}}{\delta_{(i,j)} / \lambda_k} \right| \right\}.$$

□

One can easily see that equation (3.4) gives equations (2.2) and (2.6), for the special cases of  $n = 2$  and  $n = 3$ , respectively, and equations (3.5) and (3.6) give equations (2.10) and (2.14) respectively, for the special case of  $n = 3$ .

**References**

- [1] Akça Z, Kaya R. On the distance formulae in three dimensional taxicab space. *Hadronic Journal* 2004; 27: 521-532.
- [2] Çolakoğlu HB. A generalization of the taxicab metric and related isometries. *Konuralp Journal of Mathematics* 2018; 6 (1): 158-162.
- [3] Çolakoğlu HB. The generalized taxicab group. *International Electronic Journal of Geometry* 2018; 11: 83-89.
- [4] Çolakoğlu HB. On generalized taxicab metric in three dimensional space. *Communications Faculty of Sciences University of Ankara Series A1-Mathematics and Statistics* 2019; 68 (2): 1359-1369.
- [5] Çolakoğlu HB. Area of a triangle in terms of the  $m$ -generalized taxicab distance. *Konuralp Journal of Mathematics* 2019; 7 (1): 222-227.
- [6] Deza MM, Deza E. *Encyclopedia of Distances*. Berlin,Germany: Springer, 2009.
- [7] Ekmekçi S, Bayar A, Altıntaş AK. On the group of isometries of the generalized taxicab plane. *International Journal of Contemporary Mathematical Sciences* 2015; 10: 159-166.
- [8] Ekmekçi S, Akça Z, Altıntaş AK. On trigonometric functions and norm in the generalized taxicab metric. *Mathematical Sciences And Applications E-Notes* 2015; 3: 27-33.
- [9] Krause EF. *Taxicab Geometry*. New York, NY, USA: Dover, 1986.
- [10] Menger K. *You will like geometry*. Guidebook of Illinois Institute of Technology Geometry Exhibit, Museum of Science and Industry, Chicago: Illinois, 1952.
- [11] Wallen LJ. Kepler, the taxicab metric, and beyond: an isoperimetric primer. *The College Mathematics Journal* 1995; 26: 178-190.