

PAPR reduction using genetic algorithm in lifting-based wavelet packet modulation systems

Necmi TAŞPINAR¹, Yüksel TOKUR BOZKURT^{2,*}

¹Department of Electrical and Electronic Engineering, Erciyes University, Kayseri, Turkey

²Department of Electronic and Automation, Vocational School of Higher Education in Gaziantep, Gaziantep University, Gaziantep, Turkey

Received: 27.06.2013

Accepted/Published Online: 23.10.2013

Final Version: 01.01.2016

Abstract: Wavelet packet modulation (WPM) is a potential candidate in wireless communication systems by virtue of its flexibility and modular implementation capability. However, WPM suffers from high peak-to-average power ratio (PAPR), which results in signal distortion when a high-power amplifier is employed at the transmitter. The partial transmit sequence (PTS) is an attractive PAPR reduction method, but its computational complexity is high. In this paper, we propose a PTS based on the genetic algorithm (GA) scheme (GA-PTS) to reduce the computational complexity of the PTS in the lifting-based WPM (LBWPM) systems. Simulation results show that the proposed GA-PTS scheme provides significant improvement in PAPR reduction while maintaining a low computational load. The cumulative distribution function performance of the LBWPM system is better than the performance of the classical WPM.

Key words: Peak-to-average power ratio, wavelet packet modulation, partial transmit sequence, genetic algorithm

1. Introduction

Multicarrier transmission systems have well-known advantages, such as high bandwidth efficiency, efficient implementation, narrowband interference, and robustness to frequency-selective fading. Besides these advantages, it has high side lobes, requires the use of cyclic prefix, is sensitive to time and frequency synchronization, and suffers from intercarrier interference, narrowband interference, intersymbol interference, and high peak-to-average power ratio [1–4].

The above disadvantages of orthogonal frequency division multiplexing (OFDM) systems can be eliminated or reduced with the use of wavelet transforms instead of fast Fourier transform (FFT). The spectral efficiency of OFDM systems can also be improved with the use of wavelet transforms. For example, the orthogonality in time and frequency domains eliminates the requirement of a cyclic prefix or guard interval, and also results in lower side lobes in the transmitted signal, which in turn reduces the intercarrier interference and narrowband interference.

According to the construction method of wavelets, wavelet transforms have different classifications and characteristics like the first-generation wavelet transform and the second-generation wavelet transform. The wavelet transforms that use Fourier analysis as a fundamental tool for transformation are called classical or first-generation wavelet transforms [5]. They have been used successfully for signal processing and image processing applications [6]. The wavelet transform that uses a lifting scheme for the generation of wavelets is called lifting-

*Correspondence: tokur@gantep.edu.tr

based wavelet transform (LBWT) or integer wavelet transform. The lifted wavelet transform eliminates the limitations of first-generation wavelet transform such as implementation only for periodic or infinite signals. In addition, due to the elimination of Fourier analysis, computational efficiency of the LBWT is greater than that of first-generation wavelet transform [7,8].

The replacement of FFT by wavelet transforms in OFDM (WOFDM) does not eliminate high PAPR, which is also the major drawback of WOFDM. High PAPR reduces the efficiency of OFDM systems by decreasing the efficiency of radiofrequency power amplifiers and increasing the complexity of analog-to-digital and digital-to-analog conversions. In the literature, clipping [9], clipping and filtering [10], tone injection [11], tone reservation [12], coding [13], peak windowing [14], active constellation extension [15], interleaving [16], selected mapping [17], and the partial transmit sequence (PTS) [18,19] are used to reduce the PAPR. All these methods reduce the PAPR at a different level and each of them have their own advantages and disadvantages. The most commonly used method among these techniques is the PTS scheme.

The PTS scheme consists of the following steps: division of input signal into several disjoint subblocks, transformation of subblocks using inverse FFT for OFDM and inverse discrete wavelet transform for WOFDM, rotation of subblocks by a set of phase factors, and lastly summation of subblocks. An increase in the number of subblocks and phase factors causes a considerable amount of computations. In this paper, the PTS is combined with a genetic algorithm (GA) to decrease the computational complexity.

The GA is a type of evolutionary computing and it searches the probabilities by simulating natural evolution. It is generally used in optimization problems to find useful solutions. In this work, a GA is applied to obtain optimum phase factors that reduce the PAPR [20].

The paper is organized as follows: in Section 2, the system model is introduced. In Section 3, the genetic algorithm for PAPR reduction is explained. In Section 4, simulation results are given. In Section 5, the conclusions are given.

2. System model

The configuration of the system model used for the computer simulations is illustrated in Figure 1. In the system, data are interleaved to convert burst errors induced by the channel noise into random errors. Interleaved bits are modulated using QAM modulation. The modulated data flow is subjected to the inverse integer wavelet transform (IIWT) for the conversion of the data in both frequency and time domains. PTS is used for the reduction of PAPR. PTS needs side information to provide the original WPM signal at the receiver. The signal is then amplified by a high-power amplifier (HPA) and a cyclic prefix is added to the signal to rule out intersymbol interference arising from the channel. After that the data flow is transmitted over the channel. In the receiver, the cyclic prefix is pulled out from the transmitted signal. After the integer wavelet transforms, phase rotation is performed to obtain the phase of the original WPM signal by aid of the side information. After all this, the demodulation is achieved and each demodulated symbol is conveyed to the original place in the bit sequence by the deinterleaver [21].

2.1. Lifting-based wavelet transform

The proposed method uses LBWT in order to reduce the PAPR with the GA-PTS algorithm. In the LBWT, the computational efficiency is higher than the computational efficiency of the first-generation wavelet transform because the LBWT is quicker in computations by a factor of two. LBWT can be performed even faster with only integer addition and shift operations. The available data set being processed is divided into even and odd

positions. This has the advantage of not requiring temporary arrays in the calculation steps. The first step, which is called the prediction step, calculates the wavelet function in the wavelet transform. This is a high-pass filter. The updating step calculates the scaling function, which results in a smoother version of the data. This operation can be divided into split, predict, and update steps as follows [22].

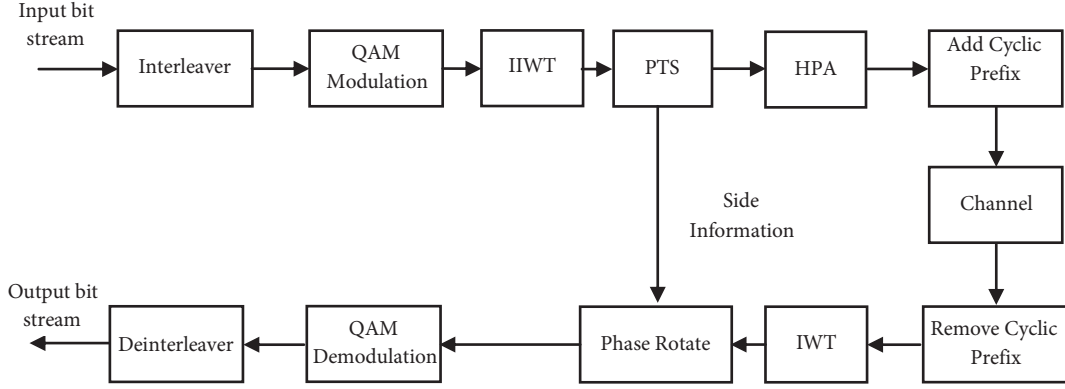

Figure 1. Block diagram of the system model.

1) First, the input signal $s_{j+1,k}$ is split into two disjoint signals, which are called the odd position signal $s_{j+1,2k+1}$ and the even position signal $s_{j+1,2k}$. These signals are modified by alternating prediction and updating operations:

$$s_{j+1,2k} s_{j+1,2k+1} = \text{Split}(s_{j+1,k}). \quad (1)$$

2) In the prediction step, the average of two adjacent even samples is calculated. For example,

$$\text{Predict}(s_{j+1,2k}) = (s_{j+1,2k} + s_{j+1,2k+2}) / 2. \quad (2)$$

It is then subtracted from the odd sample to form the prediction error. A first lifting step is given as

$$d_{j,k} = s_{j+1,2k+1} - \text{Predict}(s_{j+1,2k}), \quad (3)$$

where $d_{j,k}$ is the detail coefficient.

3) In the update step, new values of the odd samples are combined in a linear order with even samples to form the updated sequence:

$$s_{j,k} = s_{j+1,2k} + \text{Update}(d_{j,k}) \quad (4)$$

where $s_{j,k}$ is the scaling coefficient. For precise wavelets, the prediction and updating steps may be repeated several times before the result is obtained. Figure 2 shows the implementation of the lifting-based scheme.

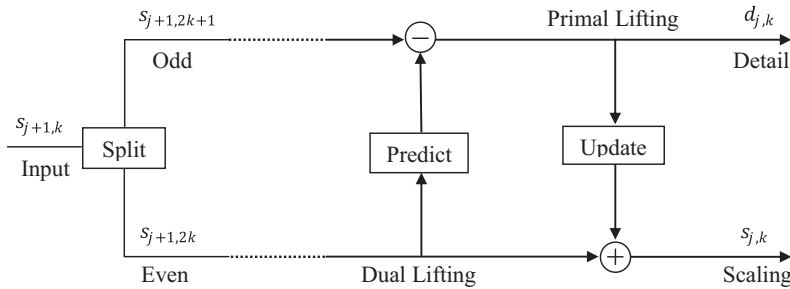

Figure 2. The implementation of lifting-based scheme.

The implementation of the inverse lifting-based scheme, which also consists of three types of operations, is illustrated in Figure 3.

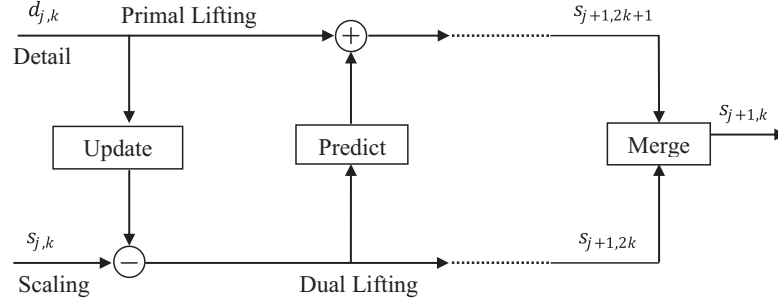

Figure 3. The implementation of the inverse lifting-based scheme.

1) The second lifting step is readily invertible and the even position signal is recovered. If Eq. (4) is reversed and the subtraction operation is put back in place of addition, a subset of the even number index is found.

$$s_{j+1,2k} = s_{j,k} - \text{Update}(d_{j,k}) \quad (5)$$

2) A subset of the odd number index is reconstructed by adding the detail coefficients and the prediction of the subset of the even number index:

$$s_{j+1,2k+1} = d_{j,k} + \text{Predict}(s_{j+1,2k}) \quad (6)$$

3) In the last stage, a signal is obtained by subsets of the odd number and even number indexes:

$$s_{j+1,k} = \text{Merge}(s_{j+1,2k}, s_{j+1,2k+1}) \quad (7)$$

3. Genetic algorithm for PAPR reduction

3.1. Genetic algorithm

The GA is an optimization method proposed in the early 1960s by John Holland. It tries to find the values that minimize a given cost function. The values are found from a solution space. Both the cost function and the solution space are defined according to the investigated problem. This operation is based on the evolution of natural systems. Natural evolution is processed in three main steps. First, a population with n chromosomes is generated randomly. Second, this population is exposed to some evolution mechanisms like crossover and mutation to form a new population with the hope of it being better. Finally, some parts of the population are selected according to their fitness values as in natural selection [23–25].

3.2. Phase factor optimization by GA

The GA serves as a solution to find a suitable phase factor set that minimizes the PAPR in a transmitted signal. It decreases the computational load of the PTS technique by searching a small piece of a set of possibilities instead of the whole set as in the classical PTS. This small set is constructed like a biological population. The population is defined by P chromosomes with M genes, where P is the population size and M is the number

of subblocks. The values of genes are referred to as phase factors in PTS and they are selected randomly for the initial population. The initial values of genes are defined as

$$\theta_i = (\theta_h - \theta_l) u - \theta_l, \quad (8)$$

where θ_h and θ_l refer to the highest and lowest values in the variable range, respectively, and u refers to random values between 0 and 1. The values -1 and 1 are used for θ_h and θ_l , respectively. The PAPR values for each chromosome are then computed by multiplying partial transmit sequences with the set of phase factors. These values are used as cost values and then they are sorted from minimum to maximum. Some chromosomes with the lowest cost values are mated together and used to construct a new population. The remaining part of the population is omitted. The new population is created by means of children chromosomes. Children chromosomes are created by the combination of some elements of each mated chromosome. This operation is called crossover. Thereafter, a local search for optimization within a chromosome is started by the modification of the position of one or more genes and it is saved as a new population for a further run of the algorithm. The termination criteria for the iteration loop are checked at this stage. If the cost value is less than a specified value or the number of iterations is greater than the maximum permissible number of iterations, the iteration loop is terminated. Otherwise, the iteration loop is repeated by the new population saved. The flowchart of the proposed GA is shown in Figure 4.

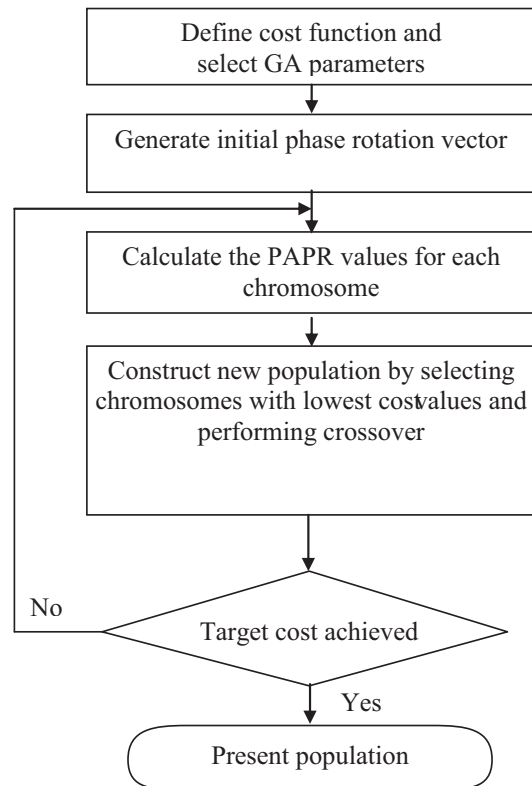

Figure 4. Flow chart of the proposed GA-PTS.

The optimization problem of PAPR is the problem of searching the optimal phase factor θ to obtain the minimum PAPR. The solutions of the potential phase factors are represented with continuous values in the GA.

Therefore, a solution is created from a continuous value by

$$\emptyset = \begin{cases} 1, & \text{if } \frac{3\pi}{4} \leq \emptyset \leq \frac{5\pi}{4} \\ -1, & \text{otherwise} \end{cases}. \quad (9)$$

3.3. PTS for PAPR reduction using GA

The PAPR of the baseband transmitted signal $x(t)$ is defined as the ratio of the peak power

$(P_{power} = \max \{|x(t)|^2\})$ of the transmitted signal to that of the average power $(P_{ave} = E \{|x(t)|^2\})$. In digital implementations of communications transceivers, rather than using the continuous time signal $x(t)$ in PAPR computation, we instead work with $x[n]$, the discrete time samples of $x(t)$. PAPR is expressed as:

$$PAPR = \frac{\max \{|x[n]|^2\}}{E \{|x[n]|^2\}}, \quad (10)$$

where E denotes the ensemble average calculated over the duration of the WPM symbol.

In this paper, the performance of the proposed PAPR reduction scheme is demonstrated through the complementary cumulative distribution function (CCDF) of PAPR, which is a performance metric. Given a value of $PAPR_0$, the probability of the event that $PAPR > PAPR_0$ is the CCDF and is expressed as follows [21]:

$$CCDF(PAPR_0) = Pr \{PAPR > PAPR_0\}. \quad (11)$$

For practical reasons, the CCDF of PAPR is calculated based on the percentage of the WPM frames for which PAPR exceeds the threshold $PAPR_0$.

The block diagram of the GA-PTS method is shown in Figure 5. In the first stage of the proposed method, data X are divided into M separated subblocks. The separated subblock X is denoted as

$$X = \sum_{m=0}^{M-1} X^{(m)}. \quad (12)$$

The subblock vectors are oversampled by $(L-1)N$ where L is oversampling factor. Oversampled subblocks are exposed to IIWT operating with size LN , and subblocks are transformed into $x^{(m)} = [x_0^{(m)}, x_{01}^{(m)}, \dots, x_{LN-1}^{(m)}]$, $0 \leq m \leq M-1$. Each subblock is rotated by phase factors $b_m = e^{j\theta_m}$, where $\theta_m \in \{\frac{2\pi k}{W} \mid k = 0, 1, \dots, W-1\}$ for $m = 1, 2, \dots, M$ and in the end the subblocks are added and the WPM signal becomes

$$x'(n) = \sum_{m=0}^{M-1} b_m x^{(m)}. \quad (13)$$

PTS is used to obtain the optimal phase factors. Since the phase factor related to the first subblocks is taken as $b_0 = 1$, there are W^{M-1} alternative b combinations, where $b = [b_0 b_1 b_2, \dots, b_{M-1}]$ and W is the number of the phase factors. In sequence b , the b_m values are as follows:

$$b_m = \pm 1 \text{ for } W = 2. \quad (14)$$

Phase rotation coefficients and phase vectors of modified subblocks are collected and then are brought together as in Eq. (13):

$$x'(n) = \sum_{m=0}^{M-1} b_m IIWT\{X^{(m)}\}. \quad (15)$$

The PAPR value of the signal is brought to the size of $1 \times N$ again and the optimal phase factors are found. After applying the PTS technique, the signal providing the value of the lowest PAPR is transmitted to the receiving side. The phase product vector providing the value of the lowest PAPR must be delivered to the receiving side.

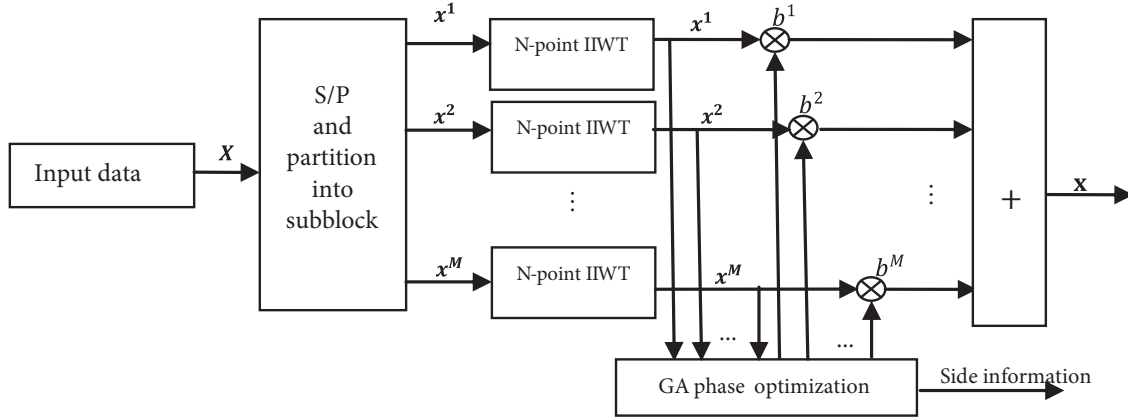

Figure 5. Blocks diagram of the GA-PTS model.

4. Simulation results

Simulations were performed using the CCDF and bit error rate (BER) criteria to verify the performance of the proposed PAPR reduction schemes. In the simulations, the performance of the proposed system is compared with the performance of the OFDM system. The systems are considered with $N = 256$ subcarriers and QAM modulation. In the PTS optimization, the number of the phase factor $W = 2$ and subblocks $M = 2, 4, 8, 16$ are chosen. The solid-state power amplifier (SSPA) is used with input back-off factor $IBO = [0, 3, 6, 9, 12]$ dB and smoothness factor $p = 2$. The communication channel is an additive white Gaussian noise (AWGN) channel. The simulation parameters are also documented in the Table 1.

In Figure 6, the variations of $PAPR_0$ (dB) versus CCDF for the classical WPM (CWPM) and lifting-based WPM (LBWPM) using 1st, 2nd, 3rd, 4th, 5th, and 6th Daubechies wavelets are given. According to Figure 6, the 2nd Daubechies wavelet yields the worst performance while the 1st Daubechies wavelet yields the best performance for the CWPM. The 6th Daubechies wavelet yields the worst performance while the 1st Daubechies wavelet yields the best performance for the LBWPM. The PAPR of the first-generation WPM using the 2nd Daubechies wavelet is $10.67dB$ and using the 1st Daubechies wavelet is $9.12dB$ when $CCDF = 10^{-3}$. The PAPR of the LBWPM using the 6th Daubechies wavelet is $7.82dB$ and using the 1st Daubechies wavelet is $6.14dB$ when $CCDF = 10^{-3}$.

In Figure 7, comparison of $PAPR_0$ (dB) versus CCDF are given for the original OFDM, original WPM, OFDM using GA, and WPM using GA with $N = 256$, $M = 16$, and $W = 2$ values. It is seen from Figure 7 that the PTS method using the GA yields better results according to the classical PTS method for OFDM and WPM systems. In addition, the PTS method using the GA for WPM yields better results than the PTS

method using the GA for OFDM. For example, the PTS method using the GA for OFDM has $6.84dB$ while the PTS method using the GA for WPM has $6.30dB$ when $CCDF = 10^{-3}$.

Table 1. Simulation parameters.

Symbol	Quantity	Value
QAM	Modulation method	
N	Number of subcarriers	256
M	Number of subblocks	2, 4, 8, 16
W	Number of phase factors	2 (± 1)
SSPA, linear amp.	Amplifier	
IBO	Input back-off	0, 3, 6, 9, 12 dB
P	Smoothness factor	2
AWGN	Channel	
G	Generation	16
P	Population	64
CR	Crossover rate	0.5
MR	Mutation rate	0.3

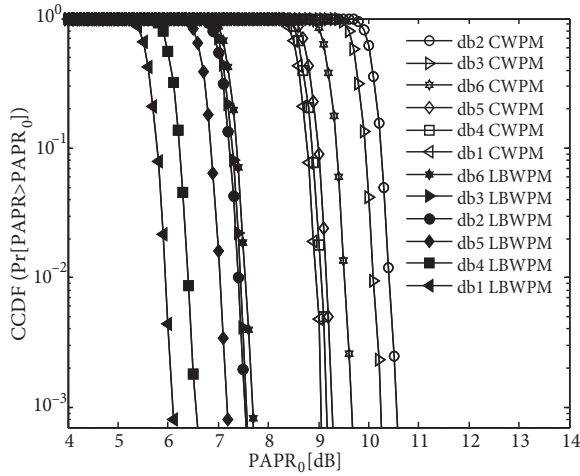

Figure 6. Comparison of the $PAPR_0$ (dB) versus CCDF of classical (first-generation) WPM and LBWPM.

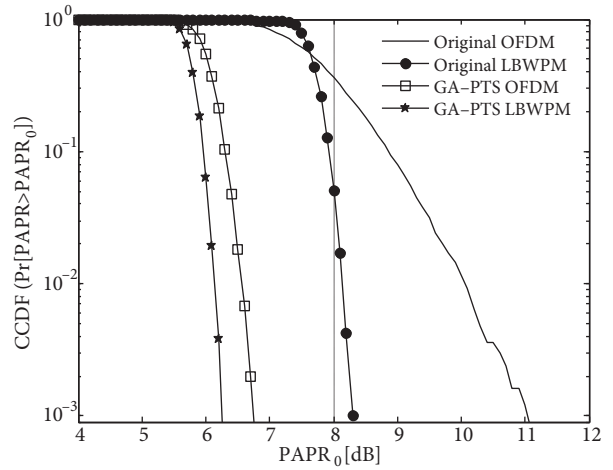

Figure 7. Comparison of the $PAPR_0$ (dB) versus CCDF for PTS method using genetic algorithm in OFDM and LBWPM systems with $N = 256$, $M = 16$, and $W = 2$ values.

In Figure 8, $PAPR_0$ (dB) versus CCDF results are shown for the LBWPM system using GA-PTS with different values of the number of subcarriers and the number of subblocks for $W = 2$. According to Figure 8, the value of PAPR decreases when the number of subcarriers and the number of subblocks increase. For example, the system with $N = 128$, $M = 2$ has $8.34dB$ and with $N = 256$, $M = 2$ has $8.11dB$ when $CCDF = 10^{-3}$. On the other hand, the system with $N = 128$, $M = 16$ has $6.57dB$ and with $N = 256$, $M = 16$ has $6.3dB$ when $CCDF = 10^{-3}$.

In Figure 9, the comparisons of the BER versus signal-to-noise ratio (SNR) are given for GA-PTS for different input back-off (IBO) values for the LBWPM system with $N = 256$, $M = 16$, and $W = 2$. It is illustrated that BER values decrease when IBO values increase. For example, the system with $IBO = 0$ yields 7×10^{-2} BER while the system with $IBO = 12$ yields 7×10^{-3} BER when $SNR = 15dB$.

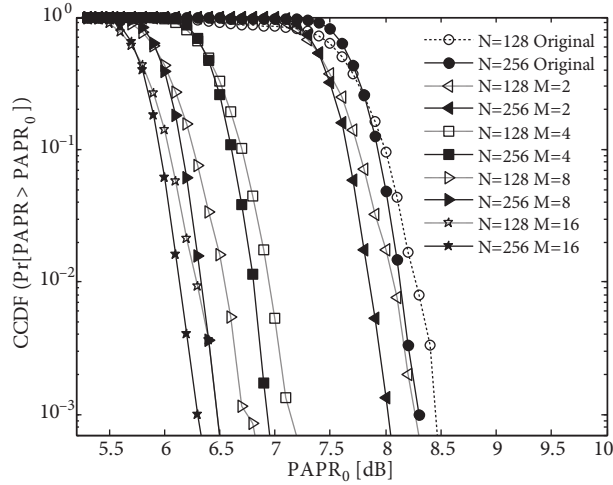

Figure 8. Comparison of the $PAPR_0$ (dB) versus CCDF for LBWPM system using GA-PTS with different values of N and M for $W = 2$.

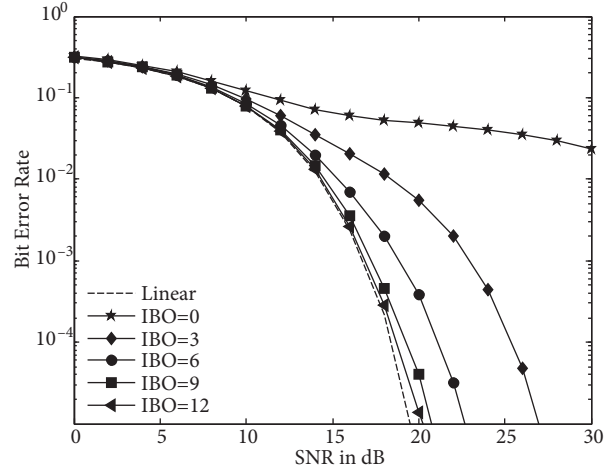

Figure 9. Comparisons of the BER versus SNR at GA-PTS for different IBO values for LBWPM system with $N = 256$, $M = 16$, and $W = 2$ values.

Table 2 shows the number of search values for OFDM, CWPM, and LBWPM using different PTS schemes to find the phase factors. It is shown that $W^{M-1} = 2^{15} = 32768$ searches are required for optimum PTS. The search complexity is proportional to $P \times G$, where P is the maximum size of the population and G is the generation. PAPR values close to optimum PTS schemes can be obtained by GA-PTS with $P \times G = 64 \times 16 = 1024$ searches and RS-PTS with 2000 searches. The GA-PTS with 1024 searches was only $0.15dB$, $0.3dB$, and $0.18dB$ higher than the optimum PTS in the LBWPM, CWPM, and OFDM systems, respectively. On the contrary, GA-PTS has only $1024/32768 = 3.12\%$ search complexity when compared with optimum PTS. Additionally, GA-PTS with 1024 searches was only $0.2dB$ higher than RS-PTS with 2000 but GA-PTS has $1024/2000 = 51.2\%$ search complexity when compared to RS-PTS in the systems.

Table 2. Computational complexity of the different PTS methods.

Method	Number of searches	PAPR (dB), OFDM	PAPR (dB), CWPM	PAPR (dB), LBWPM
Original PTS	0	11.91	9.28	8.39
Optimum PTS	$W^{M-1} = 2^{15} = 32768$	6.66	6.41	6.15
RS-PTS	2000	7.20	7.02	6.51
GA-PTS	$G \times P = 1024$	6.84	6.71	6.30

In Figure 10, $PAPR_0$ (dB) versus CCDF results are shown for the OFDM, CWPM, and LBWPM systems using optimum PTS, original PTS, RS-PTS, and GA-PTS for $N = 256$, $M = 16$, $W = 2$ values. It is seen that the PAPR performances of the GA-PTS of all systems are better than RS-PTS and are lower than optimum PTS.

Figure 11 shows a zoom version of the three systems with optimum PTS, RS-PTS, and GA-PTS. According to Figure 11, the RS-PTS method yields the worst performance while GA-PTS methods yield close to optimum PTS for all systems. For example, the LBWPM system when $CCDF = 10^{-3}$ with RS-PTS has $6.51dB$ and the LBWPM system with GA-PTS has $6.30dB$; the value with GA-PTS is only $0.15dB$ lower than the value of optimum PTS. It is also shown that GA-PTS in the LBWPM system has better PAPR reduction performance than in the CWPM and OFDM systems.

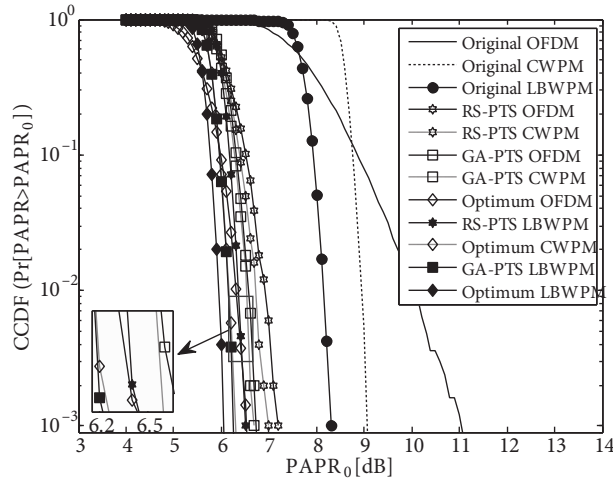

Figure 10. Comparison of the $PAPR_0$ (dB) versus CCDF in LBWPM, CWPM, and OFDM systems for optimum PTS, original PTS, RS-PTS, and GA-PTS with $N = 256$, $M = 16$, and $W = 2$ values.

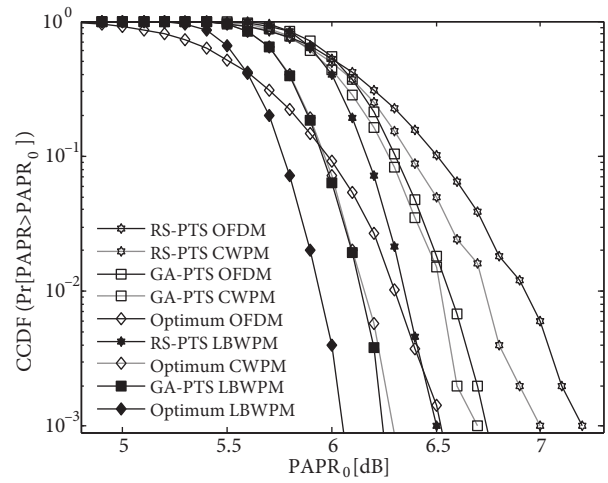

Figure 11. Zoom version of Figure 10 in the case of optimum PTS, RS-PTS, and GA-PTS in LBWPM, CWPM, and OFDM systems.

In [20,23], the GA-PTS was proposed to reduce PAPR in classical (first-generation) WPM. In Figure 12, the CCDF values are illustrated for the PTS method using the GA in CWPM and LBWPM systems for $N = 128$ and $M = 8$ subblocks. The PTS method using the GA for LBWPM yields better results than the PTS method using the GA for CWPM. For example, the PTS method using the GA for CWPM has $7.57dB$ while the PTS method using the GA for LBWPM has $6.79dB$ at $CCDF = 10^{-3}$. Here, size of population is $P = 500$ and maximum iteration (or generation) is $G = 46$ for the CWPM, while they are $P = 64$ and $G = 16$ for the LBWPM. In [20], PAPR with search complexity $P \times G = 500 \times 46 = 23000$ was $7.36dB$ when $CCDF = 10^{-2}$. In the proposed system, PAPR with the search complexity $P \times G = 64 \times 16 = 1024$ is $6.63dB$. The GA-PTS in the LBWPM system is $0.73dB$ lower than the GA-PTS in the CWPM system and the GA-PTS in the LBWPM system has only $1024/23,000 \approx 1/23$ search complexity when compared to the GA-PTS in CWPM system.

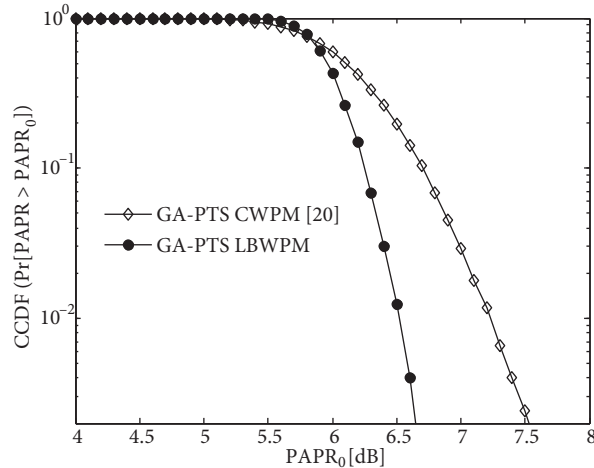

Figure 12. Comparison of $PAPR_0$ (dB) versus CCDF in LBWPM and CWPM systems for GA-PTS with $N = 128$ and $M = 8$.

5. Conclusion

In this paper, a GA is applied to PTS for the reduction of PAPR in LBWPM. The proposed method is compared with original PTS, optimum PTS, and RS-PTS in LBWPM, OFDM, and CWPM systems. Comparison of RS-PTS and GA-PTS shows that PAPR reduction performance and computational complexity of the GA-PTS are better than RS-PTS for the OFDM, CWPM, and LBWPM systems. Moreover, the PAPR performance of GA-PTS is maintained close to PAPR values of the optimum PTS while providing a low computational load. The simulation results also show that the proposed GA-PTS in LBWPM provides better PAPR reduction than GA-PTS in OFDM and CWPM.

References

- [1] Bingham JAC. Multicarrier modulation for data transmission: an idea whose time has come. *IEEE Commun Mag* 1990; 28: 5–14.
- [2] Han SH, Lee JH. PAPR reduction of OFDM signals using a reduced complexity PTS technique. *IEEE Signal Proc Let* 2004; 11: 887–890.
- [3] Han SH, Lee JH. An overview of peak-to-average power ratio reduction techniques for multicarrier transmission. *IEEE T Wirel Commun* 2005; 12: 56–65.
- [4] Müller SH, Huber JB. OFDM with reduced peak-to-average power ratio by optimum combination of partial transmit sequences. *Electron Lett* 1997; 33: 368–369.
- [5] Sweldens W. The lifting scheme: a construction of second generation wavelets. *SIAM J Math Anal* 1998; 29: 511–546.
- [6] Boix M, Cantó B. Wavelet transform application to the compression of images. *Math Comput Model* 2010; 52: 1265–1270.
- [7] Daubechies I, Sweldens W. Factoring wavelet transforms into lifting steps. *J Fourier Anal Appl* 1998; 4: 247–269.
- [8] Abd El-Hamed MA, Dessouky MI, Shawkil F, Abd El-Samie FE, Ibrahim MK. Integer wavelet transform for SC-FDMA system. In: 8th International Conference on Informatics and Systems; 14–16 May 2012; Cairo, Egypt. New York, NY, USA: IEEE. pp. 26–35.
- [9] Wang Y, Chen W, Tellambura C. Genetic algorithm based nearly optimal peak reduction tone selection for adaptive amplitude clipping PAPR reduction. *IEEE T Broadcast* 2012; 58: 462–471.
- [10] Li X, Cimini LJ. Effect of clipping and filtering on the performance of OFDM. *IEEE Commun Lett* 1998; 2: 131–133.
- [11] Chen JC, Wen CK. PAPR reduction of OFDM signal using cross-entropy-based tone injection schemes. *IEEE Signal Proc Let* 2010; 17: 727–730.
- [12] Chen JC, Li CP. Tone reservation using near-optimal peak reduction tone set selection algorithm for PAPR reduction in OFDM systems. *IEEE Signal Proc Let* 2010; 17: 933–936.
- [13] Jones AE, Wilkinson TA, Barton SK. Block coding scheme for reduction of peak to mean envelope power ratio of multicarrier transmission scheme. *Electron Lett* 1994; 30: 2098–2099.
- [14] Chen G, Ansari R, Yingwei Y. Improved peak windowing for PAPR reduction in OFDM. In: *IEEE Vehicular Technology Conference; 26–29 April 2009; Barcelona, Spain*. New York, NY, USA: IEEE. pp. 1–5.
- [15] Krongold BS, Jones DL. PAR reduction in OFDM via active constellation extension. *IEEE T Broadcast* 2003; 49: 258–268.
- [16] Jayalath ADS, Tellambura C. Reducing the peak-to-average power ratio of an OFDM signal through bit or symbol interleaving. *Electron Lett* 2000; 36: 1161–1163.
- [17] Jie Y, Lei C, Quan L, De C. A modified selected mapping technique to reduce the peak-to-average power ratio of OFDM signal. *IEEE T Consum Electr* 2007; 53: 846–851.

- [18] Chen JC. Partial transmit sequences for PAPR reduction of OFDM signals with stochastic optimization techniques. *IEEE T Consum Electr* 2010; 56: 1229–1234.
- [19] Lei L, Wang Q, Lu CY, Li L. A low complexity PTS phase coefficient searching algorithm for OFDM system. In: *5th International Conference on Wireless Communications Networking and Mobile Computing*; 24–26 September 2009; Beijing, China. New York, NY, USA: IEEE. pp. 1–4.
- [20] Lixia M, Murrioni M. Peak-to-average power ratio reduction in multi-carrier system using genetic algorithms. *IET Signal Process* 2011; 5: 356–363.
- [21] Taşpınar N, Karaboğ a D, Yıldırım M, Akay B. PAPR reduction using artificial bee colony algorithm in OFDM systems. *Turk J Electr Eng Co* 2011; 19: 47–58.
- [22] Jain C, Chaudhary V, Jain K, Karsoliya S. Performance analysis of integer wavelet transform for image compression. In: *3rd International Conference on Electronics Computer Technology*; 8–10 April 2011; Kanyakumari, India. New York, NY, USA: IEEE. pp. 244–246.
- [23] Lixia M, Murrioni M, Popescu V. PAPR reduction in multicarrier modulations using genetic algorithms. In: *12th International Conference on Optimization of Electrical and Electronic Equipment*; 20–22 May 2010; Brasov, Romania. New York, NY, USA: IEEE. pp. 938–942.
- [24] Liang H, Chen Y, Huang Y, Cheng C. A modified genetic algorithm PTS technique for PAPR reduction in OFDM systems. In: *15th Asia-Pacific Conference on Communications*; 8–10 October 2009; Shanghai, China. New York, NY, USA: IEEE. pp 182–185.
- [25] Falehi AD, Rostami M, Doroudi A, Ashrafian A. Optimization and coordination of SVC-based supplementary controllers and PSSs to improve power system stability using a genetic algorithm. *Turk J Electr Eng Co* 2012; 20: 639–654.